

UNIVERSITÀ CA' FOSCARI VENEZIA

**UNIVERSITY OF VENICE
WORKING PAPERS
IN LINGUISTICS**

VOLUME 19 - 2009

edited by Laura Brugè

Dipartimento di Scienze del Linguaggio

Università Ca' Foscari Venezia

Ca' Bembo - Dorsoduro 1075

30123 Venezia

Tel.: +39-412345704; Fax: +39-412345706

laurabrg@unive.it

cinque@unive.it

Table of Contents:

The syntax of noun modification in Italian Sign language (LIS) <i>Carmela Bertone</i>	7
Greenberg's Universal 23 and SVO languages <i>Guglielmo Cinque</i>	29
Five notes on Correlatives <i>Guglielmo Cinque</i>	35
Remarks on PRO _{arb} <i>Francesco Costantini and Vesselina Laskova</i>	61
Quantifiers as negative markers in Italian dialects <i>Jacopo Garzonio and Cecilia Poletto</i>	81
A Grammar of Italian Sequence of Tense <i>Alessandra Giorgi</i>	111
On feature sharing and feature transfer <i>Giuliana Giusti</i>	157
Towards a Hierarchy of Clause Types <i>Nicola Munaro</i>	175

The syntax of noun modification in Italian Sign language (LIS)

Carmela Bertone
University of Venice

1. Introduction

In this paper I will discuss noun modification in LIS. Before starting the discussion some clarification is at stake.

The grammatical categories of Italian Sign Language (LIS) are not morphologically distinguished: nouns, verbs or adjectives have the same lexical form. How can words of LIS be categorized in different classes? At first glance it seems that there are no distinctions in LIS.

In recent syntactic literature, the noun phrase has been analysed as having a structure similar to clausal structure (Abney 1987; Bernstein 1991, 2001; Cinque 1994; 2000; Giusti 1993, 1996, 2002). This leads us to the prediction that in LIS a phrase is initially indistinguishable if verbal or nominal. In the next section I try to delineate the principal facts that signal if a word functions as a noun, an adjective or a verb. I will claim that the presence of a determiner is a means to distinguish a nominal constituent. In this introductory part I introduce two key factors to interpret the phenomena described hereafter: non-manual markers and the pointing sign. Non-manual markers consist in various facial expressions, head and shoulder movements, mouthing, and similar markers that are added to the hand signs to create meaning. Their role in syntax can be compared to the role of suprasegmental features. As suprasegmentals do in many oral languages, non-manual markers may indicate whether a sentence is a question, a command, or a statement. They can give emphasis, contrast or focus. Moreover, in LIS, their role in sentence is fundamental because they substitute other linguistic elements not encoded by functional manual signs (for example some modification or the verb *to be* when it is a copula).

The pointing sign is a linguistic means to distinguish a specific referent, it has regular distribution in the sentence, and it has a specific grammatical function. It is different from a pointing gesture, which can also accompany deictic word in oral language, and it can overlap with it. Pointing signs can be demonstratives and pronouns, they encode the space features of *proximity to* or *distality from* the speaker and the addressee that are fundamental for the interpretation of the referent. Space features assign referential meaning to the pointed space that can result in morphological agreement with some verbs.

Section 2 will distinguish nominal and verbal constituents in LIS. Section 3 will observe that normally in LIS adjective agreement is not obligatory, instead we can speak of “assimilation”, in the sense pointed out by Mac Laughlin for ASL (1997:206), and the adjective agreement is overt only when the adjectives are pronominal forms of the noun. Section 4 reports on attributive and predicative adjectives that are distinguished by means of suprasegmental features. Section 5 regards direct modification and its development in compound nouns. Section 6 shows distributional property of direct modifier. In section 7 I explain the structure of direct and indirect modification.

2. The distinction between nominal constituent and verbal constituent in LIS

In the following examples, we can observe the phonological absence of the copula in LIS, the position of some adjectives, the distinction between NP and VP and the syntactic value of some facial expressions. For example, in (1), the word *antique* is a predicate, in (2) it is an adjective.

- (1) *d.h.*: $\frac{\text{FURNITURE}_i}{\text{DP}} \quad \frac{\text{ANTIQUE}}{\text{VP}}$
n.d.h.: $\text{IX}_{\text{---}i}$
 The furniture is antique
- (2) *d.h.*: $\frac{\text{FURNITURE}_i \text{ ANTIQUE}}{\text{DP}} \quad \frac{\text{IX}_i \text{ BROKE}}{\text{VP}}$
 The antique furniture is broken

The non-manual markings that distinguish the nominal constituent from a verbal constituent can be different in different signers for intensity, or for the kind of

expression, but generally consist in raised eyebrows and the assumption of a slightly raised position of the head with a jutting forward of the chin. The lines labelled DP or VP indicate the domain over which the non-manual marking occurs and the manual sign with which it is co-articulated. These two kinds of non-manual markings show that, although the kind of expression or body movement are not so fixed, there is a break between the nominal constituent and verbal constituent. In both (1) and (2) we can see that the word *antique* is characterized by two distinct expressions and by the post-nominal position in the sentences. In (1) the break is between the noun and its predicate. Since there is no copula, it is possible to argue that *antique* is the verbal constituent. As we can see in (1) and (2), the pointing (IX in the glosses) in LIS is the last element of the noun phrase. In previous works (cf. Bertone 2007, 2009), I claimed that the pointing is the phonetic realization of space features that are distinguishable in terms of *proximity to* or *distality from* the speaker and the addressee. The point in space is referential because it realizes the referent of the noun phrase and triggers agreement. For this reason, I propose it is a determiner inserted in D. In (1), it is not possible to have the pointing sign (IX) after the predicate. If it is necessary to have a pointing sign, *i.e.* if we need to specify which piece of furniture among many, then this must be necessarily put after the noun. In the glosses, it is possible to note that the pointing sign is articulated, between the noun and its predicate, by the non-dominant hand (*n.d.h.*). In (2) the break is between the pointing sign (IX) and the sign *broke*, so the pointing sign is the last sign of the nominal constituent; the sign *antique* is characterized by the same non-manual marker of the noun; a break between the *furniture* and *antique* would make the sentence non-grammatical.

Antique in (1) cannot be the head of a relative sentence; instead in (2) we can insert a relative clause in which the noun phrase (*furniture antique*) is the head of a relative clause as we can see in (3):

- $$\begin{array}{c} \text{DP} \qquad \qquad \qquad \text{relative} \qquad \qquad \qquad \text{VP} \\ \text{(3) FURNITURE}_i \text{ ANTIQUE (IX)}_i, \text{ PE}_i \text{ UNCLE MY GIVEN}_{1p} \text{ BROKE} \\ \text{The antique furniture, which my uncle gave me, is broken} \end{array}$$

To summarize, non-manual markings are prosodic elements that can change a predicate NP, like *antique* in (1), into an argument DP like *antique* in (2). The same prosodic element permits us to distinguish whether an element is part of a nominal constituent. In the following sentence the adjective *red*, with its pointing sign, is not part of the DP.

- _____ DP _____ DP _____ VP
- (4) FURNITURE_i ANTIQUE (IX)_i, RED (IX)_i, BROKE
 The antique furniture, the red one (which is red), is broken

The two DPs are separated by a pause and/or by a nod of the head. The facial expression can spread either over the first noun phrase, or over the second, or over both with an interruption as is the case in (4).

It is now clear that non-manual markings help us distinguish the properties of constituents, their role can be assimilated to functional elements that in many languages are expressed phonetically or prosodically.

3. Adjective agreement

In LIS, nouns and verbs are divided in different classes related to the possibility they have to be reduplicated in the plural. For example there are two classes of nouns (Pizzuto 1987; Pizzuto, Giuranna, Gambino 1990; Pizzuto, Cameracanna, Corazza, Volterra 1997 a.o.), one is articulated on the body and generally, cannot be reduplicated, the other is articulated in space and can be reduplicated. So the first class is “plain” the second class is “agreeing”. In both cases it is possible to use a quantifier to express plurality. The verbs are divided in three classes concerning the agreement with their arguments (cf. Pizzuto 1987; Caselli, Maragna, Pagliari Rampelli, Volterra 1994).

Like nouns and verbs, adjectives are also divided into two classes: the agreeing adjectives, located in space (*tall, new, blue*), and the non-agreeing adjectives, located on the signer’s body (*pretty, old, red*). Moreover, “form” and “dimension” adjectives, that are homophones to the classifiers predicates, also are agreeing adjectives. These latter ones will be not discussed in the present paper for reasons of space. (But cf. Bertone (2007) for a proposal on agreement of modification incorporated to the classifier).

The morphological agreement of adjectives involve modification of features of space and orientations of the hand. Both have to be localized in the same point of space in which we have previously localized the noun. With uninflected adjectives (those articulated on the signer’s body that cannot modify the point of articulation) the agreement is given by body or head tilt, which often also involves eye gaze turning towards the point indicated by the determiner (index) or by the noun¹ articulated in a

¹. In case of a plain noun, that cannot be located in space, the classifier of the noun replace it, as pronominal form, and (Bertone 2007).

specific point of space. Adjective agreement is not obligatory: often agreeing adjectives are not articulated in the same point in which the noun is localized but are articulated in neutral space. If there is a pointing sign, it has to agree while the adjective is assimilated to the pointing sign. In this case we can speak of “assimilation” in the sense pointed out by Mac Laughlin for ASL (1997:206). That is, the adjective is shifted to the location of the referent followed by the pointing sign.

Shifting of the adjectives, to a point in space, is obligatory with a conjunction between two referents whose referent is associated to a specific point (5), and when the noun is missing (6).

- _____ head direction i _____ head direction k
- (5) BOOK_i BLUE_i BOOK_k NEW_k,
The blue book and the new book

- _____ head direction i _____ head direction k
- (6) (speaking about books) BLUE_i (IX)_i NEW_k (IX)_k ,
The (that) blue and the (that) new

In LIS, the agreement of the adjective is overt when the adjectives are pronominal form of the noun, as we see in (6) in which each adjective (*blue* and *new*) refers to a specific book. The pointing sign in (6), is the determiner and the adjective is assimilated to the pointing sign. In conclusion adjectives require agreement when they assume the function of a determiner.

4. Distributional property and non manual markers

As we have seen in section 2, the DP in LIS is characterized by specific non-manual elements that spread over the entire phrase. Inside this extension the noun is followed by an adjective. Contrary to languages such as Italian, English, in which the position of the adjective gives information about its attributive or predicative role, in LIS both kinds of adjectives follow the noun. Nevertheless, we will soon see that the difference between the two kinds of modification is indicated by specific non-manual features.

In LIS, all kinds of adjectives are post-nominal. Attributive and predicative adjectives are distinguished by a different marking. The first ones have the same facial expression of the noun referred to, moreover it is impossible to insert lexical material between the

noun and its adjective; the latter are characterized by more salient facial expression, such as squinted eyes or raising eyebrows, which are more emphasized compared to the expression of the whole DP. Moreover, it is possible to have a pause, often with a head nod, after the predicative adjective, but not after an attributive adjective. It is also possible to introduce a particular sign, or gesture, made by the manual handshape “5” (open hand with outstretched fingers) or by manual configuration “f” (open hand with thumb and index fingertips touching each other) after the predicative adjective (sentences (7) and (8)).

- _____ non manual expression of DP
eyebrows more raised
or squinted eyes
- (7) ICE CREAM GOOD, **ITALIAN** COST MORE
 A good ice cream that is Italian, costs more.

- _____ non manual expression of DP
eyebrows more raised
or squinted eyes
- (8) ICE CREAM ITALIAN, **GOOD** COST MORE
 An Italian ice cream, that is good, costs more.

In the sentences (7) and (8), the adjectives in bold are prosodically more marked and there is a slight pause between the two adjectives indicated by the comma in the glosses. The pointing sign, that in non-marked forms is at the end of the DP (sentences (1) and (2)), cannot be between a noun and its direct modifier.

- _____ non manual expression of DP
eyebrows more raised
or squinted eyes
- (9) ICE CREAM (*IX) GOOD, **ITALIAN** (IX) COST MORE
 A good ice cream, that is Italian, costs more.

As we have seen above, both attributive and predicative adjectives are post-nominal. However, in LIS there are some forms in which the attributive adjective is pre-nominal such as *prime minister* and *former husband* or *former pupil*. In these cases we have some evidences of borrowing from the Italian language: the word “*former*”, in Italian

language “*ex*”, is made by a sign crossing the indexes finger on the shoulder. That is, the word “*ex*” is given by a fingerspelled word from which the “E” is dropped and letter “X” is articulated using the old system of fingerspelling. The point of articulation, that is on the shoulder, means *past*. In the same way, the word *prime*, in Italian language “*primo*” (first), is given by a sign (thumb upwards) that is the literal translation of the Italian word. This clearly means that these signs are words borrowed from Italian, they were direct modifiers and became into compound nouns. These words can therefore be regarded as compound nouns rather than adjectives followed by a noun. This fact proves that direct modification can give rise to the formation of new compound nouns (Sproat & Shih 1988).

The rules of intonation, in LIS accounted for by facial expressions, seem to follow the same rules of direct and indirect modification of Mandarin as pointed out by Sproat & Shih (1990). Direct modification in LIS, is accounted for the same expression of the face, without interruption, which spreads over the noun and its modifier. In sentences (7) and (8) the pause in intonation between two adjectives, the intensification of the facial expression that emphasizes the second adjective, the fact that this has the same facial expression of the relative clause, all provide the evidence of the fact that the adjectives in bold are indirect modifiers. In the next sentence (10) we see a typical expression of a relative clause. In LIS it is characterized by specific non-manual expressions such as dimpled cheeks and squinted eyes.

- _____ dimpled cheek
_____ squinted eyes
- (10) DRESS RED IX_{1p+2p} YESTERDAY SEE CL_{num+position}, IX_{1p} BUY DONE
The red dress that we have seen yesterday among the others, I bought it

Sentence (10) does not have a relative pronoun², moreover the non-manual features characterizing it (eyebrows more raised or squinted eyes) are identical to those that characterize the marked phrases in bold in the sentences (7), (8) and (9). Chomsky (1955), Kayne (1994), Larson, (2004) Cinque (2005a, 2005b), and other authors claim

². In Cecchetto, Geraci Zucchi (2006). A relative clause is characterized by specific non-manual feature ad by a relative pronoun (pro-rel) that in sentences (7a) and (10a) is given by the word PE. There are attested case in which the relative clause occur without the PE (I tanks Mirko Santoro and Fabio Poletti for the colloquies on these topics). The function of PE seams invests fields of research larger. Branchini, Donati (2005).

that predicative adjectives are derived by reduced relative clauses. LIS give evidence for this hypothesis. Further evidence for this is the observation that marked adjectives are a kind of indirect modification. In sentences (7), (8) and (10), it is possible to introduce a sign, glossed as PE by a phonetic sound pronounced with it, that also characterizes the relative clause in LIS (cf Cecchetto Geraci Zucchi (2006), Branchini (2009), Brunelli (2009)).

_____ non manual expression of DP
 _____ squinted eyes
 (7a) ICE CREAM GOOD, (PE) ITALIAN COST MORE

_____ dimpled cheek
 _____ squinted eyes
 (10a) DRESS RED (PE) IX_{1p+2p} IESTERDAY SEE CL_{num+position}, IX_{1p} BUY DONE

The interpretation of the relative clause is restrictive. The meaning of the adjective ITALIAN in (7a) is ambiguous between restrictive and non-restrictive, the reason will be clear below.

Since marked adjectives are derived from a reduced relative clause, they are not subject to the order restriction of direct modification (Sproat & Shih 1991; Scott 2002). The non-marked order of the sentence (7) is given in (11):

_____ non manual expression of DP
 (11) ICE CREAM ITALIAN GOOD, COST MORE
 A good Italian ice-cream costs more

_____ non manual expression of DP
 (11a) ? ICE CREAM GOOD ITALIAN, COST MORE

These five pieces of evidence (intonation pause, facial expression identical to the expression of relative clause, possibility of PE insertion, restrictive reading of marked adjectives, free order of adjectives) lead us to believe that these adjectives are predicative and the different kind of modification, direct or indirect, is left to prosodic markers.

5. Some aspects of direct modification

Before analyzing the distribution of direct modifiers inside DP, some aspects regarding relational adjectives and adjectives of origin have to be looked at. The category of adjectives derived by nouns in LIS is not signalled by a specific morpheme. In LIS words, with same semantic content but belonging to different categories, such as *financial* ad *finance* are not morphologically distinguished and the sign is identical for the noun and for the adjective. The possibility to identify the category of belonging to, it is left to the position in the phrase, the adjective which is next to the noun has the same non-manual features and any kind of element can be insert between them.

non manual expression of DP

(12) ACT FINANCE
Financial act

(13) *FINANCE_j IX_j ACT_j

expr DP _____squinted eyes

(14) *ACT FINANCE

Relational adjectives are direct modifier. In LIS they are widespread, for example we find the following expressions:

(15) a. MAN GLASS
Man with glasses

b. MAN HAT
Man with hat

c. BOOK HISTORY
History book

The contrast of the last phrase (15c) to “history of book” is given by the phrase BOOK HISTORY_j POSS_j. Where *poss* is a sign that needs to mark the genitive.

As relational adjectives, adjectives of origin too have the same non-manual features that spread over the noun, and any kind of element can insert between them. It is necessary

to explain that if the characterization is not pragmatically strong, there needs to be a possessor marker such as BOOK HISTORY POSS (sentences (16c), (16e)). Instead, if the adjective of origin indicates the name of a place generally recognized as typical, the possessor marker is not necessary (contrast (16a) and (16d)).

- (16) a. WINE FRENCH
Franch wine
- b. ?WINE FRANCE_j POSS_j
- c. WINE AMERICA_j POSS_j
American wine
- d. ?WINE AMERICA
- e. PIZZA POLAND_j POSS_j
Polish pizza
- f. ?PIZZA POLAND
- d. PIZZA NAPOLI
Neapolitan pizza

From this we conclude that modifiers behave differently depending on the grammatical category of belonging to. Moreover we can note that some words became compound depending on the use in different communities of deaf.

6. Order restriction of non-marked adjective, or direct modifier, in LIS

Showing that direct modification is not non-manually distinct from the noun, but is joint with the noun through the same non-manual feature, we can now shift our attention to look at the hierarchy of attributive adjectives in LIS.

Sproat & Shih (1988, 1990), state that there are restrictions on the ordering of the adjectives, the restrictions are universal and they apply only to direct modifiers. As cross-linguistically it is not a unitary phenomena, the order of adjectival modification is

another type of analysis such as the grammatical status of the classifier in which modifier is only a morpheme.

In order to account the reversal of adjective order in LIS, I am taking the position of Cinque (1994, 2005a, 2005b) who, criticising the common assumption that adjectives are adjoined to a maximal projection (Abney 1987, Bernstein 1991, Carstens 1991 et. al.), states that adjectives are phrases generated in specifiers of distinct functional projections, between the D and NP.

Scott (2002) examines the adjective order restriction (AOR), following the position of Cinque (1994) and making a parallel between DP and CP, taking into account the adverbial order of Cinque (1999), he identifies the functional projections that are intrinsically related to the aspect of their semantic interpretation outlining that there exists an interaction between the syntactic and semantic components of grammar. The functional projections maintain a semantic relationship with every class of modifiers (verbal in CP and nominal in DP) in their specifiers so the interpretation of the adjectives is influenced by a hierarchical order of the projection of FP in which AP is generated. The syntactic tree is given in the following figure.

Fig. (2)

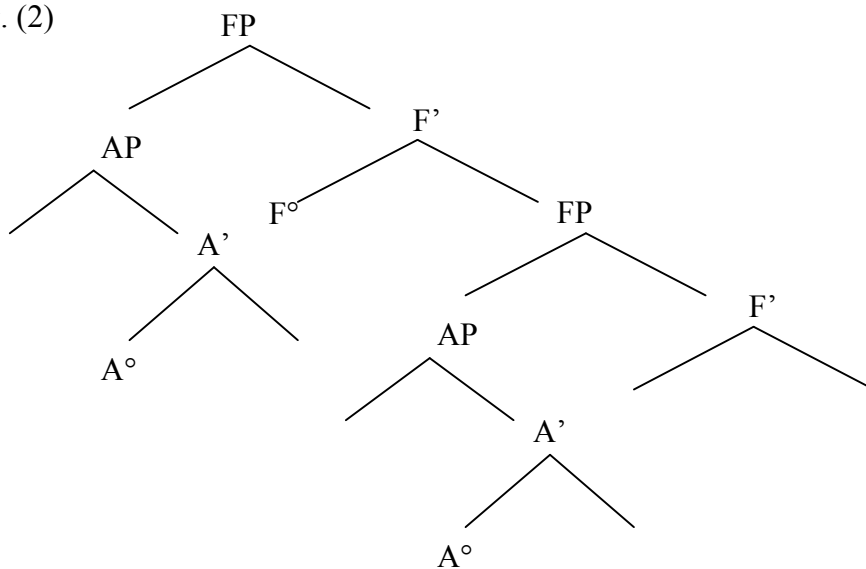

As Scott (2002) outlines, the projection FP can host in its specifier elements such as PP, AdvP, CIP that are related to the semantic interpretation of the FP. In that sense, it is possible to understand the interpretation of a relational adjective as in MAN GLASS or BOOK HISTORY, in which GLASS and HISTORY is generated in the projection of FP related to “subjunctive comment”, or PIZZA NAPLES in which NAPLES receives its interpretation because is generated in FP related the “Nationality/OriginP”.

The words in LIS that need the possessive marker such as PIZZA POLAND; POSS; would be a PP, instead of an AP, in the same position of FP.

This argument could contribute to the definition of the position of classifier too. But this problem needs further research.

7. Structure of Direct and indirect modification

We adopt the antisymmetry of syntax (Kayne 1994), and Cinque's (2005b) claim that the projections of direct modification are generated near the noun, while the indirect modification, deriving from a reduced relative clause, are in a higher position of extended projection of DP. Cinque (2005b) provides a projection of AgrP over every FP that hosts a modifier, in order to host in Spec AgrP the movements of NP that raises by its lower positions of the extended projection of DP. The NP moves successively to each Spec pied-piping the category that dominates it, in a roll-up fashion that reverses the order of the modifiers and obtains the noun in initial position.

This assumption can explain the inverted order of modifier in LIS. Let us observe the sentences (7), renumbered here as (21), and the sentence (22):

- non manual expression of DP
eyebrows more raised
or squinted eyes
- (21) ICE CREAM GOOD, ITALIAN COST MORE
 An Italian ice cream that is good, costs more.

- head forward without interruption
- (22) VASE CINA BIG
 A big Chinese vase

The adjective of origin in (21) has non-manual markers in the sense that it has a free order in the sentence. The movement of the noun is the following:

Fig.(3)

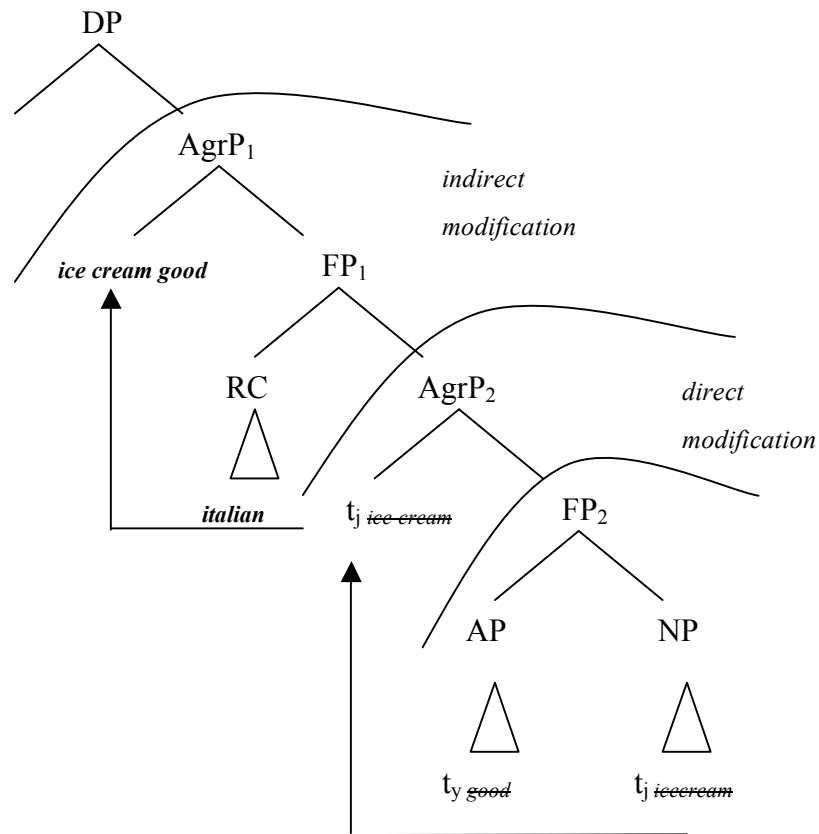

The NP moves from the position in which it is base-generated, it rolls up to the left of the AP and raises to the position of the specifier of AgrP where it checks its agreement feature against AgrP°. AgrP₂ dominates FP₂. The AP is base-generated in the specifier of FP₂. Both AgrP and FP raise and, stepping over the FP of predicative adjective, will be host in the specifier of AgrP₁. In this way direct modification will be to the left of indirect modification. This proposal can explain the distribution of non-manual features: some features (raised eyebrows, slightly raised position of the head with a jutting forward of the chin) spread over the entire domain of DP, other features (squinted eyes, dimpled cheeks) overlap the first spreading over the domain of indirect modification (relative clause). The raising of modified NP over the projection of the relative clause, explains the restrictive interpretation of the predicative adjective ITALIAN. This is equivalent to saying that in the group of good ice creams only those which are Italian cost more. In the sentence (22) the adjective of origin is not prosodically marked, for this reason it is near the adjective and it modifies directly the noun; the measure adjective (BIG) modifies the modified noun (Sproat a Shih (1988)):

head forward without interruption

- (22) VASE CINA BIG
A big Chinese vase

VASE is initially modified from the provenience adjective:

[FP1 [AP1 CINA] [NP VASE]]

The adjective of dimension AP₁ modifies the modified noun:

[FP2 [AP2 BIG][FP1 [AP1 CINA][NP VASE]]]

According to the movements illustrated in fig. (3), for the sentence (21) we have the following movements:

[AgrP2 ... [FP2 [AP2 BIG] [AgrP1 ... [FP1 [AP1 CHINA] [NP VASE]]]]]

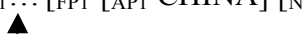

[AgrP2 ... [FP2 [AP2 BIG] [AgrP1 [NP VASE] [FP1 [AP1 CHINA]]]]]

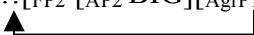

[AgrP2 [AgrP1 [NP VASE] [FP1 [AP1 CHINA]]] [FP2 [AP2 BIG]]]

In the same manner, we can explain the other orders of adjectives in the sentences indicate above.

8. Some consideration on Greenberg's Universal 20: the order of demonstrative numeral adjective and noun

Greenberg's (1963) Universal 20 observes that in pre-nominal position the order of demonstrative, numeral and adjective is: Dem>Num>A> Noun. In post-nominal position is the same, that is N> Dem>Num>A or the mirror order N> A >Num> Dem. Cinque (2005) states that the post-nominal order has proven both too restrictive and too permissive. He explains, following Kayne's (1994) antisymmetry of syntax, how the other orders attested in natural languages can be derived. Cinque clarifies that of 24 possible orders only 14 are attested in natural languages. In this section, I will consider

the orders of the four elements attested in LIS. I will exploit the assumption of Cinque who states that the deep order is the pre-nominal order of Greenberg's Universal 20 (Dem>Num>A>N). Cinque demonstrates that derivation of other orders is due to total or partial raising of NP plus *pied-piping* of the categories that dominates the NP.

Let us consider a sentence in which numeral, demonstrative and adjective modify the noun. The more natural order in LIS is N > A > Num > Dem. Other orders are not grammatical but scrambled orders require specific non-manual markers. As regards the order of adjectives less marked is the next:

- _____ DP
- (23) BOOK NEW TWO IX_i, MINE
This two new books are mine

Following Cinque (2005), this order has a derivation from the order:

[AgrP3 ...Dem....[AgrP2Num [AgrP1 A [NP_N]]]].

Involving raising of NP to the specifier of AgrP that dominates the adjective, we have:

[AgrP3 ...Dem....[AgrP2Num [AgrP1[NP_N] A]]]
with successive *pied-piping* of the other modifiers:

[AgrP3...Dem....[AgrP2 [AgrP1[NP_N] A]....Num]]

[AgrP3...[AgrP2 [AgrP1[NP_N] A]....Num] Dem....]

Others attested order in LIS are (24), (25) and (26):

N>Num>A>Dem:

- _____ DP
- (24) BOOK TWO NEW IX_i, MINE

In case (23) the sentence has a derivation with raising of NP without *pied-piping* around A and Num, followed by a raising plus *pied-piping* around the demonstrative.

Dem>N>A >Num >index:

_____ DP

(25) IX_i BOOK NEW TWO IX_i, MINE

Dem>N>Num>A>index:

_____ DP

(26) IX_i BOOK TWO NEW IX_i, MINE

The orders (25) and (26) are rather rare. The pre-nominal position of the demonstrative requires a repetition of the pointing sign at the end of the constituent. The last pointing sign is the determiner that has the same sign of the demonstrative. The last pointing sign can be substituted by a classifier, the classifier has the same function of the determiner because classifier and pointing sign, both have the same space features that I assumed in head of DP (Bertone 2007, 2009).

For the order in (24), the derived structure is given from these movements:

$[AgrP_3 \dots Dem [AgrP_2 Num \dots [AgrP_1 A [NP N]]]]$

NP moves around the adjective to Spec AgrP₁

$[AgrP_3 \dots Dem [AgrP_2 Num \dots [AgrP_1 [NP N] A]]]$

Then AgrP₁ moves, with remnant movement, to Spec AgrP₂

$[AgrP_3 \dots Dem [AgrP_2 [AgrP_1 [NP N] A] Num]]$

AgrP₃ moves to the specifier of higher DP, leaving the determiner (index) at the end of sentence.

$[DP [AgrP_3 \dots Dem [AgrP_2 [AgrP_1 [NP N] A] Num]] index]$.

For the order in (26) the derived structure is given as follows:

$[AgrP_3 \dots Dem [AgrP_2 Num [AgrP_1 \dots A [NP N]]]]$

NP moves around the adjective to Spec AgrP₁

[AgrP₃ ...Dem [AgrP₂ Num [AgrP₁ [NP_N]A]]]

Then it moves, without remnant movement, to Spec AgrP₂:

[AgrP₃ ...Dem [AgrP₂ [NP_N]Num [AgrP₁ ... A]]]

AgrP₃ moves to specifier of DP, leaving the determiner (index) at the end of sentence.

[DP [AgrP₃ ...Dem [AgrP [NP_N]Num [AgrP₁ ... A]]] index]

These facts prove that in LIS the different orders of the elements in DP can be explained by Cinque's (2005) proposal according to which partial roll-up raising of NP can involve other elements included in the extended projection of DP or not.

Conclusions

The evidence discussed in this paper points to the conclusion that LIS, just as other languages is subject to the same rules which are identified observing other natural languages. Some structures of LIS, that are apparently poor, can be explained through systems of grammaticalization of natural languages. In this manner it is possible to explain how the system of direct modification of noun substitutes Prepositional Phrases, how some suprasegmental features constitute a key to explain some grammatical aspects of modification, how the distribution of the adjectives in LIS can be explained through total or partial roll-up raising of NP plus *pied-piping* of the categories that dominates the NP.

This work is the first stage of a more complex study aiming to explore the cartography of modification in LIS taking into account the modification conveyed by classifiers which however does not yet have a full explanation.

Glossary

	Example	Meaning
Symbol		
IX	IX ₁ GO	IX is abbreviation for “index”, it is an indicating point.
2p, 3p	IX ₁	1p is 1st person etc., 1p+2p refers to 1st person and 2nd person, it is plural.
1p+2p	IX _{1p+2p}	
k,y,j,	BURN _y	Letter refer to specific point of space. Which have to agree with other signs.
Cl	Cl	Classifier
<i>d.h.- n.d.h.</i>	<i>n.d.h.</i> : FURNITURE _i <i>d.h.</i> : <u>IX</u> _____ _i	<i>d.h.</i> is dominant hand. <i>n.d.h.</i> is non dominant hand. While one hand articulates a sign, the other articulates the other sign. The underlining refers to the holding of the sign.
Line over the words	_____ <i>GIVE</i>	It refers the suprasegmental feature that spreads with the word.
()	(MANY)	Parenthesis refers to the possibility to omit the sign.
*	* IX _{2p} 1GIVE ₂	non grammatical.
?	? _x TOUCH	quite accepted.
,	HOUSE, WHERE?	Comma means a pause.

References

- Abney, S. 1987. *The English Noun Phrase and Its Sentential Aspect*. MIT PhD dissertation.
- Bernstein, J.B. 1991. "DPs in French and Wallon: Evidence for Parametric Variation in Nominal Head Movement". *Probus* 3.2, 101-126.
- Bernstein, J.B. 2001. "The DP Hypothesis: Identifying Clausal Properties in the Nominal Domain". In M. Baltin, C. Collins, *The Handbook of Contemporary Syntactic Theory*. Oxford: Blackwell, 537-561.
- Bertone, C. 2007. *La struttura del sintagma determinante nella Lingua dei Segni Italiana (LIS)*. Doctoral thesis, University of Venice.
- Bertone, C. 2008. "Esiste un genere in LIS?". In Bagnara, C., S. Corazza, S. Fontana and A. Zuccalà (eds.), *I segni parlano – Prospettive di ricerca sulla Lingua dei Segni Italiana*. Roma: Franco Angeli.
- Bertone C. 2009. "Aspetti della sintassi dello spazio" In Bertone, C. and A. Cardinaletti (eds), *Alcuni capitoli della grammatica della LIS. Atti dell'Incontro di studio "La grammatica della Lingua dei segni italiana"*. Venezia: Cafoscarina, 79-100.
- Branchini C. 2009. "Relative libere e interrogative Wh- in LIS". In Bertone, C. and A. Cardinaletti (eds.), *Alcuni capitoli della grammatica della LIS. Atti dell'Incontro di studio "La grammatica della Lingua dei segni italiana"*. Venezia: Cafoscarina, 101-116.
- Branchini, C. and C. Donati. 2005. *Exploring the Chinese Trail*. Handout presented to the workshop "Signa Volant" 22-24 June 2005, Università degli Studi Bicocca, Milano.
- Brunelli M. 2009. "La "sinistra" periferia sinistra: sintassi della Lingua dei Segni Italiana, analizzata alla luce dell'Antisimmetria e dello split-CP". In Bertone, C. and A. Cardinaletti (eds.), *Alcuni capitoli della grammatica della LIS. Atti dell'Incontro di studio "La grammatica della Lingua dei segni italiana"*. Venezia: Cafoscarina, 117-136.
- Caselli, M.C., S. Maragna, L. Pagliari Rampolli and V. Volterra. 1994. *Linguaggio e Sordità*, Firenze: La Nuova Italia.
- Carstens, V.M. 1991. *The morphology and syntax of determiner phrases in Kiswahili*. Ph. D. Diss. UCLA.
- Cecchetto, C., C. Geraci and S. Zucchi. 2006. "Strategies of relativization in Italian Sign Language". *Natural Language and Linguistic Theory* 24, 945-975.
- Chomsky, N. 1995. *The Minimalist Program*, Cambridge, Mass.: MIT Press.

- Cinque, G. 1994. "On the Evidence for Partial N-movement in the Romance DP". In G. Cinque, J. Koster, J.Y. Pollock, L. Rizzi and R. Zanuttini (eds.), *Paths towards Universal Grammar: Studies in honour of Richard S. Kayne*. Washington: Georgetown University Press, 85-110.
- Cinque, G. 1999. *Adverbs and Functional Heads: A Cross-Linguistic Perspective*, New York: Oxford University Press.
- Cinque, G. 2000. "On Greenberg's Universal 20 and Semitic DP". *University of Venice Working Papers in Linguistics*, vol.10 (2), 45-61.
- Cinque, G. 2002. "Mapping Functional Structure: A Project". In G. Cinque (ed.), *Functional Structure in DP and IP: The Cartography of Syntactic Structures*, vol.1, New York: Oxford University Press, 3-11.
- Cinque, G. 2005a. "Deriving Greenberg's Universal 20 and Its Exceptions". *Linguistic Inquiry*, 36, 315-332.
- Cinque, G. 2005b. "The Dual Source of Adjective and Phrasal Movement in The Romance DP". Manuscript, University of Venice.
- Giusti, G. 1993. *La sintassi dei determinanti*. Padova: Unipress.
- Giusti, G. 1996. "Is there a TopP and a FocP in the noun phrase?". *Working Papers in Linguistic* University of Venice. 6.1, 105-128.
- Giusti, G. 2002. "The functional structure of Noun Phrase. A bare structure approach". In G. Cinque, (ed.), *Functional Structure in DP and IP: The Cartography of Syntactic Structures*, vol., OUP, Oxford. 54-90.
- Giusti, G. 2005. "At the left periphery of the Rumenian noun phrase". In M. Coene and L. Tasmowsky (eds.), *Proceedings of the Tense and Aspect Conference*. Cluj (Romania): Clusium.
- Greenberg, J. 1963. "Some universals of grammar with particular reference to the order of meaningful elements". In J. Greenberg (ed.), *Universals of language*. Cambridge, Mass.: MIT Press, 73-113.
- Kayne, R. S. 1994. *The antisymmetry of syntax*. Cambridge, Mass.: MIT Press.
- Larson, R.K. and F. Marušić. 2004. "On Indefinite Pronoun Structures with Aps: Reply to Kishimoto". *Linguistic Inquiry* 35, 268-287.
- Mac Laughlin, D. 1997. *The Structure of Determiner Phrase: Evidence From American Sign Language*. PhD Dissertation.
- Pizzuto, E. 1987. "Aspetti morfosintattici" In V. Volterra (ed.), *La lingua italiana dei segni. La comunicazione visivo gestuale dei sordi*. Bologna: Il Mulino, 179-209.
- Pizzuto, E., E. Giuranna and G. Gambino. 1990. "Manual and Nonmanual Morphology in Italian Sign Language: Grammatical Constraints and Discourse Processes". In

- C. Lucas (eds.), *Sign Language Research: Theoretical Issues*. Washington, D.C.: Gallaudet University Press, 83-102.
- Pizzuto, E., E. Cameracanna, S. Corazza and V. Volterra. 1997. "Morfologia dei nomi e classificatori nella lingua dei segni italiana". In Caselli M.C., Corazza S. (eds.), *LIS- Studi, esperienze e ricerche sulla Lingua dei Segni in Italia - Atti del 1 Convegno Nazionale Sulla Lingua dei Segni*. Tirrenia (PI) Edizioni Del Cerro, 34-41.
- Scott, G.J. 2002. "Stacked Adjectival Modification and Structure of Nominal Phrases. In G. Cinque (ed.), *Functional Structure in DP and IP: The Cartography of Syntactic Structures*, vol. 1. New York: Oxford University Press, 91-120.
- Sproat, R. and C. Shih. 1988. "Prenominal Adjectival Ordering in English and Mandarin". In *Proceeding of the Eighteenth Annual Meeting of North Eastern Linguistics Society 18*, 465-489.
- Sproat, R. and C. Shih. 1990. "The Cross-Linguistic distribution of Adjective Ordering Restriction". In C. Georgopoulos, R. Ishihara (ed), *Interdisciplinary Approaches to the Language*. Dordrecht: Kluwer, 565-593.

Greenberg's Universal 23 and SVO languages

Guglielmo Cinque

University of Venice

That the order of proper noun and common noun, when co-occurring, (partially) correlates with the order of the genitive with respect to the N (hence with the VO/OV order) is recognized in Greenberg (1966²,88). See his Universal 23, given in (1):

(1) If in apposition the proper noun usually precedes the common noun, then the language is one in which the governing noun precedes its dependent genitive. With much better than chance frequency, if the common noun usually precedes the proper noun, the dependent genitive precedes its governing noun.

In other terms: proper noun > common noun implies N > Gen and (with much better than chance frequency) common noun > proper noun implies Gen > N.

Curiously, the correlation appears to be just the opposite. In note 19, Greenberg gives the list of languages for which he has some data on common noun/proper noun orders: "Languages with common noun-proper noun are Greek, Guarani, Italian, Malay, Serbian, Swahili, Thai, Welsh, Zapotec. Those with proper noun-common noun are Basque, Burmese, Burushaski, Finnish, Norwegian, Nubian and Turkish".

The former are largely N > Gen (VO) languages and the latter Gen > N (mostly OV) languages.

The inadvertent reversal of the correlation on Greenberg's part was observed in Bennett (1979) (also see Elisa Roma's comment in the Konstanz Universals Archive, no.9 (<http://typo.unikonstanz.de/archive/nav/browse.php?number=1&PHPSESSID=6c5f3dab8f93ca11c93476206d2e587f>)).

It is in fact the case that many head-initial languages and head-final languages display a mirror-image order of the two. I only consider here a subset of the different kinds of

University of Venice

Working Papers in Linguistics

Vol. 19, 2009

proper noun/common noun pairs (titles of address, names of places, calendar time appellations, and a few others), but this suffices to make the point. See the case of Hebrew (VSO) and that of Japanese (SOV) in (2):

(2)	a. Hebrew (VSO,NG) (Tal Siloni, p.c.)	b. Japanese (SOV,GN) (Yoshio Endo, p.c.)
year/number	be-šnat 1950 (in-year 1950)	1950 nen (1950 year)
hour/number	be-ša'a 8 (at-hour 8)	hati zi (8 hour)
month/name	be-xodeš may (in-month May)	zyuu gatu '(lit.) ten month' (the month of October)
title/name	profesor xomski	Chomsky kyoozyu
street/name	rexov gordon (street Gordon)	Asakusa doori (Asakusa street)
city/name	ba-ir xeyfa (in.the-city Haifa)	Chiba si (Chiba city)
mountain/name	har miron (mount Miron)	Fuji yama (Fuji mountain)
island/name	iyey fokland (islands Falkland)	Tori sima (Tori island)
river/name	nehar ha-yarden (river the-Jordan)	Edo gawa (Edo river)
colour/name	mexonit be-ceva adom (car in-colour red)	Ki iroi kuruma ((lit.) yellow colour car)
letter/name	ha-ot kaf (the-letter "k")	k" to yuu roomazi ((lit.) k called letter)

Consideration of the relative order of common noun and proper noun in SVO languages shows that they are not as homogeneous a group as one might think. I illustrate it here with the following SVO languages: Chinese, Norwegian, Bulgarian, English, Greek, and Italian (also indicating the relative position of the Genitive and Noun, which, as already noted in Greenberg's (1966²,89), appears to be related to some extent). Each of these languages happens to behave differently from the others.¹

¹. Interestingly, VO Chinese, Norwegian, Bulgarian and English display more head-final pairs in the proper noun/common noun order than OV German. Cf. (3)a and b and (4)a-b with *Im Jahre 1950*, **Um 8 Uhr**, (**Im Mai Monat**)/Im Monat Mai, **Maximilianstrasse**, In der Stadt Berlin, **Der Cervino Berg** /der Berg Cervino, Die Insel Rügen, Der Fluss Rhein, **Ein rot farbiges Auto**, Buchstabe "k".

(3)	a. Chinese ² (GN)	b. Norwegian (GN/NG) ³ (Øystein Nilsen p.c.)
year/number	yi-jiu-wu-ling nian (1-9-5-0 year)	år 1950
hour/number	ba dian (zhong) (8 point (clock))	klokken åtte (clock.the 8)
month/name	wu yue (five month ‘month of May)	Mai måned (May month)
title/name	Qiaomusiji jiaoshou	Professor Chomsky
street/name	Huaer jie (Wall street)	Lovisenberggata (Lovisenberg street)
city/name	Beijing shi	Oslo by/byen Oslo
mountain/name	Zhumu Langma feng	Galdhøpiggen (Galdhø (pointed) mountain)
island/name	Huaite dao	Senjaøya/ øya Senja
river/name	Yangzi jiang	Viggaelva/elva Vigga (the river Vigga)
colour/name	hong (yan)se (red colour)	en rødfarget bil (a red-coloured car)
letter/name	zimu “k”	“k” bokstaven/ bokstaven “k” (“k” letter.def)
(4)	a. Bulgarian (GN/NG) (Iliyana Krapova p.c.)	b. English (GN/NG)
year/number	v 1950 godina (in 1950 year)	(in the) year 1950
hour/number	v osem časa (at 8 hour)	(at) 8 o’clock
month/name	v mai mesets/mesets mai	(in the) month of May
title/name	profesor Čomski	Professor Chomsky
street/name	ulitsa Rakovski	Wall street
city/name	grad Sofia/ Sofia-grad	(the) city of Boston/ New York city

². For the Chinese data I am indebted to Candice Chi Hang Cheung, Francesca del Gobbo and Chi Fung Lam.

³. To judge from Tsunoda (1992), closely related Swedish may conform more to the common noun > proper noun order of head-initial languages.

mountain/name	Pirin planina /planinata Pirin	<i>Mount</i> Auburn/ Auburn Mountain
island/name	ostrov Corsica	<i>isle</i> of Wight/ Ellis island
river/name	reka Maritsa	(the) river Mississippi/ Mississippi river
colour/name	kola tsvjat červen/ červen tsvjat	a red color car (Kayne 2005,289)
letter/name	bukva “k”	the letter “k”
(5)	a. Greek (NG(GN)) (Arhonto Terzi, p.c.)	b. Italian (NG)
year/number	to (etos) 1950	l'anno 1950 (the year 1950)
hour/number	okto (i ora)	le ore 8 (8 o'clock)
month/name	o minas Maios/o Maios minas	il mese di maggio (the month of May)
title/name	(o) kathigitis Chomsky	(il) professor Chomsky
street/name	i odos Kolokotroni	via Garibaldi
city/name	i poli tu Londinu	la città del Cairo (the city of the Cairo)
mountain/name	to oros Olibos	(il) monte Grappa (Mount Grappa)
island/name	to nisi (tis) Mitilinis	l'isola di Wight (the <i>isle</i> of Wight)
river/name	o Ilisos potamos /o potamos Ilisos	(il) fiume Mississippi (the river Mississippi)
colour/name	Ena aftokinito kokinu xromatos	una macchina (di) color rosso (a car (of) color red)
letter/name	to grama “k”	(la) lettera “k”

Incidentally, proper nouns are possibly always specifiers of a common noun, whether overt or silent (Kayne 2007, Appendix). Confirming evidence comes from certain agreement facts, which become understandable if a silent head is postulated that controls the agreement: *città* ‘city (fem.sing.)’ in (6)a (cf. Cinque 2008,fn.11); *lettera* ‘letter (fem.sing.)’ in (17)b; and *ore* (fem.pl.) and *ora* ‘hour (fem. sing.)’ in (17)c:

- (6) a. Il Cairo (CITTA') è stata, e resta, il centro più importante del mondo arabo.
 The (masc.sg.) Cairo (masc.sg.) ('city (fem.sg.)) has been (fem.sg.), and remains, the most important center of the Arab world.
- b. la "o", la "k", etc. (scilicet LETTERA 'letter (fem.sg.))
 the (fem.sg.) "o", "k"
- c. Sono le una (i.e., Sono le ORE una ORA)⁴
 (Lit.) are the (fem.pl.) one (fem.sg.) 'it is one o'clock'

References

- Bennett, P. A. 1979. On Universal 23. *Linguistic Inquiry* 10.510-511.
- Cinque, G. 2008. Two Types of Nonrestrictive Relatives. In O.Bonami and P.Cabredo Hofherr (eds.), *Empirical Issues in Syntax and Semantics 7*. Paris, pp. 99–137 (<http://www.cssp.cnrs.fr/eiss7>)
- Greenberg, J. 1966². Some universals of grammar with particular reference to the order of meaningful elements. In J. Greenberg (ed.), *Universals of language*. Cambridge (Mass.): MIT Press, pp.73-113.
- Kayne, R.S. 2003. Silent Years, Silent Hours. In L.-O. Delsing et al. (eds.), *Grammar in Focus. Festschrift for Christer Platzack. Vol.2*. 209-226. Lund: Wallin and Dalholm (also in Kayne 2005 *Movement and Silence*, pp.241-260).

⁴. See Kayne (2003). Also see the perfectly corresponding case in Modern Greek (Arhonto Terzi, p.c.), where the first plural article becomes understandable if there is a silent ORES 'hours':

(i) *s-tis [okto i ora]* ORES

at-the (fem.pl.acc.) [eight the (fem.sing.nom) hour (fem.sing.nom)] HOURS (fem.pl.acc.)

When 'street' is missing, Bulgarian has the name of the street in the feminine, presumably agreeing with *ulitsa* (fem.):

v ulitsa Rakovski (in Rakovski street) vs. *v Rakovska* (Iliyana Krapova, p.c.).

- Kayne, R.S. 2005. Antisymmetry and Japanese. In Idem *Movement and Silence*. 215-240. New York: Oxford University Press.
- Kayne, R.S. 2007. On the Syntax of Quantity in English. In J.Bayer, T.Bhattacharya and M.T. Hany Babu (eds.), *Linguistic Theory and South Asian Languages. Essays in honour of K.A.Jayaseelan*. 73-105. Amsterdam: Benjamins (also in R.Kayne 2005 *Movement and Silence*. 176-214. New York: Oxford University Press).
- Tsunoda, T. 1992. Typological study of word order (10): Swedish, and (11) Q'eqchi'. *Studies in Language and Literature. Language* (Nagoya) 21.121-156 (<https://www.tulips.tsukuba.ac.jp/dspace/handle/2241/13581>).

Five notes on Correlatives¹

Guglielmo Cinque

University of Venice

Introduction

In Cinque (in preparation) (see Cinque 2008 for a preliminary presentation) it is proposed that the different types of relative constructions found across languages (externally headed post-nominal, externally headed pre-nominal, internally headed, ‘headless’ (or ‘free’), correlative, and ‘adjoined’ or extraposed) derive from one and the same structure, whether they involve a raising or a matching derivation.

This unique structure, in compliance with Antisymmetry (Kayne 1994), has the relative clause merged pre-nominally, in a specifier of the extended projection of the NP; more precisely between the position of numerals (and other weak determiners, in the sense of Milsark 1974), and that of demonstratives (and other strong determiners, like the definite article and universal quantifiers).²

¹. Parts of this article were presented at the 7th Glow in Asia (Hyderabad, February 25-27, 2009), and the 4th Lissim Summer School (Kausani, Uttarakhand, June 10-30, 2009). I wish to thank the audiences of the two events, in particular R. Amritavalli, Tanmoy Bhattacharya, Probal Dasgupta, Veneeta Dayal, K.A. Jayaseelan, and Alice Davison, Richard Kayne, Ghanshyam Sharma, and Alessandro Zucchi for discussing specific points of the analysis with me.

². An independent conceptual argument for the prenominal origin of relative clauses appears to come from the pervasive left-right asymmetry of natural languages discussed in Cinque (2009). I take this asymmetry to suggest that the complements, modifiers, and functional heads associated with a lexical head (N, V, etc.) should be merged exclusively to the left of the lexical head, their possible surface

University of Venice

Working Papers in Linguistics

Vol. 19, 2009

See (1), which represents the (simplified) structure underlying the relative clause *the expensive books that John bought*.

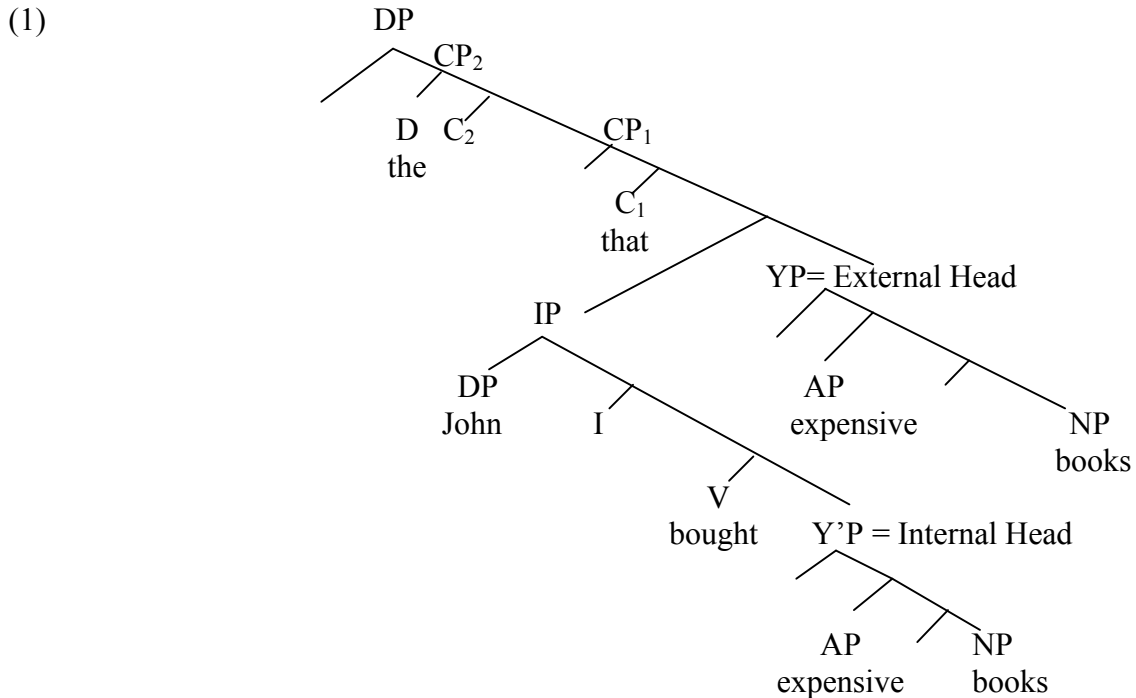

The phrase directly modified by the relative clause (YP in (1)) is the *external Head* of the relative clause, which is matched inside the relative clause by an identical phrase (Y'P, the *internal Head*).

Whenever interpretive factors require reconstruction of the *overt* Head inside the relative clause (idiom chunks, pronominals within the Head bound inside the relative clause, etc.), it is the internal Head which raises to a position c-commanding the external Head (Spec,C₁), causing the latter to delete. Instead, when nothing forces reconstruction of the Head inside the relative clause, the *overt* Head is the external Head, which raises to a position c-commanding the internal Head (Spec,C₂), whether the latter moves or not, and deletes (or 'reduces') it. See Krapova (2009) for evidence to this effect from Bulgarian relatives.

location to its right being a function of the raising of a projection of the lexical head to their left. See Cinque (2009) for an elaboration of this point.

For present purposes it suffices to note that under this analysis all relative constructions, ‘headless’/ ‘free’ relatives included, are double headed (they have both an external and an internal Head). For example, English ‘headless’/‘free’ relative clauses would receive the following analysis, arguably with recoverable deletion (from the particular *wh*-phrase involved) of such functional nouns as THING, AMOUNT, PLACE, TIME, PERSON,...³

- (2) a. (I don’t like) [DP[CP what THING_i you said t_i] (SUCH) THING]
 b. (He weighs) [DP[CP what AMOUNT_i I weigh t_i] (SUCH) AMOUNT]
 c. (Here is) [DP[CP where PLACE_i they slept t_i] THERE PLACE]
 d. (Come) [DP[CP when TIME_i you can t_i] THEN TIME]
 e. (He helps) [DP[CP whoever PERSON_i t_i needs it] (SUCH) PERSON]

See Cinque (2008, and in preparation) for discussion of such an analysis.

If correct, this proposal prompts a reconsideration of certain aspects of the analysis of correlatives.

NOTE 1: *Simple correlatives as ‘left dislocated’ DPs resumed IP-internally*

Following a certain tradition, by ‘simple correlatives’ I mean those correlatives that contain a single *wh*-phrase, like that in (3):⁴

³. For discussion of some of the other contexts in which the presence of such silent functional nouns can be postulated, see Kayne (2004, 2005a, 2007).

⁴. See Rebuschi (1999,68) for the similar idea that the correlative clause may just be “la partie visible d’une véritable relative libre topicalisée.”, and especially Gupta (1986, chapter 5), who concludes: “Thus, internal [correlative] and postnominal relative constructions display characteristics of “left dislocated” NPs. These same traits are not evident in extranominal [extraposed] relative sentences” (p.91). Also see Lipták (2004), Dasgupta (2006), Butt, King and Roth (2007, §4.3), and Rebuschi (2009, §3.3). As we see below, the term ‘left dislocated DP’ corresponds in different languages to different types of ‘left dislocation’ constructions, while the element resuming the relative in the matrix IP may be represented either by a full DP (see for example (i) below, from Marathi- Renuka Ozarkar, p.c. – which incidentally redresses McCawley’s 2004,300 generalization), or by a demonstrative (possibly followed by a head noun), as shown in (3), or by an anaphoric pronoun, which can also be silent, depending on the Case it bears, and the particular language involved.

- (3) **jo laRkii** khaRii hai, vo (laRkii) lambii hai (Cf. Dayal 1996,160)
 which girl standing be-PR, she/that (girl) tall be-PR
 ‘which girl is standing, she is tall’

An influential analysis of this construction takes the left peripheral relative to be a bare CP, adjoined to the matrix IP, which contains a pronominal (or demonstrative) bound by that CP: See Srivastav (1991), and Dayal (1996).⁵

This analysis is the only conceivable one if both simple correlatives and multiple correlatives (those containing more than one wh-phrase, like (4)) are taken to represent one and the same construction.

-
- (i) [jyaa aattaa-c aalyaa aahet] **Tyaa laal Dres ghaat-le-lyaa**
 which now-emph come-PAST.FEM be-PRES.PL those red dress wear-PAST.PART-FEM
don Chotyaa mulii...
 two small/young girls...
 ‘Those two small girls wearing a red dress who have just arrived...’

In languages that have both demonstratives and special anaphoric correlative pronouns, the two may have different semantic consequences. See Bagchi’s (1994) discussion on Bangla.

Sometime the phrase in the matrix IP which resumes the left peripheral relative is considered as the (external) Head of the relative clause. But this is misleading if the correlative pronoun (phrase) is nothing other than a phrase resuming a ‘left dislocated’ DP (for multiple correlatives, see NOTE 3 below).

⁵. Also see Andrews (1975) and Hale (1976). Among the works that essentially adopt this analysis are Bagchi (1994), Bianchi (1999, chapter 3, section 4.1), de Vries (2002, chapter 5, section 6), Cecchetto, Geraci and Zucchi (2006), Leung (2007c), and various contributions in Lipták (2009). Differently from Srivastav (1991) and Dayal (1996), Bhatt (2003, 2005) argues that the CP is not base-generated as an adjunct to the matrix IP, but is moved there from a position inside the matrix IP adjoined to the correlative pronoun or demonstrative (Mahajan 2000,fn.10 also proposes a movement derivation of the left peripheral relative). In this way, the fact that the relation between the CP and the correlative pronoun or demonstrative in the matrix IP is sensitive to islands can be made to follow. A similar analysis is actually adumbrated in de Vries (2002, 149, fn.49), and Dayal herself (1996, chapter 6, section 2.4) admits that the CP can in certain cases be adjoined to the DP containing the correlative pronoun or demonstrative, and also mentions elsewhere (p.183) that the relation between the two, when they are separated, is subject to island constraints.

- (4) jis laRkii-ne_i jis laRke_j-ke saath khelaa, us-ne_i us-ko_j haraayaa
 (Dayal 1996,197)
 which girl-ERG which boy with play.PAST, she-ERG he-ACC defeated
 ‘which girl played with which boy, she defeated him’

Clearly a DP analysis for such cases is out of the question since the correlative CP cannot have two external Heads (cf. Downing 1973,13; Dasgupta 1980,291; Srivastav 1988,148; de Vries 2002,147; Bhatt 2005,9; Anderson 2005,5fn3).⁶ Correlatives would thus seem to pose a problem for any unified analysis of relative clauses that takes them to be embedded in a DP.

There is however evidence (discussed in Bhatt 2003, 2005) that multiple and simple correlatives do not constitute a homogeneous construction and thus should not be forced under one and the same analysis that “generalizes to the worst case” (that of multiple correlatives).

Some of this evidence will be recalled in NOTE 3 below, where multiple correlatives will actually be taken to be free adjunct clauses (in Izvorski’s 2000 sense), along the lines of Dayal’s original analysis.⁷

Here suffice it to observe that simple correlatives like those in (3) contain a ‘free’ relative which may alternate with an externally headed postnominal relative. Compare (3) with (5):

⁶. In addition to (simple and multiple) correlatives, Hindi has externally headed embedded ((i)a) and extraposed ((i)b) postnominal relative clauses, which share properties setting them apart from (simple and multiple) correlatives (see, among others, Srivastav 1991, Mahajan 2000, McCawley 2004, Leung 2007a,b, Butt, King and Roth 2007, §3). Here I will not be concerned with these other types of relative clauses.

- (i) a. vo laRkii **jo khaRii hai** lambii hai (Srivastav 1991,642)
 that girl which standing is tall is
 b. vo laRkii lambii hai **jo khaRii hai** (Srivastav 1991,642)
 that girl tall is which standing is
 ‘The girl who is standing is tall’

⁷. Butt, King and Roth (2007, section 5) also give a non relative clause analysis for multiple correlatives (adjunction to IP) distinct from that for simple correlatives (generation in a specifier of the correlative DP).

- (5) vo laRkii jo khaRii hai, vo lambii hai (cf. Dayal 1996,152)
 that girl which standing be-PR, she/that tall be-PR
 ‘which girl is standing, she is tall’

Taking (3) and (5) together into consideration, and the double headed analysis of ‘headless’/‘free’ relatives given in (2), it becomes possible to interpret (3) as having a silent external Head, as in (7):⁸

- (7) [DP VO LARKII [CP jo laRkii khaRii hai]] vo laRkii lambii hai
 THAT GIRL which girl standing be-PR, that GIRL tall be-PR
 ‘the girl who is standing, that girl is tall’

Veneeta Dayal (p.c.) tells me that she in fact marginally accepts (8), which shows the underlying structure of (3) and (5) on its sleeve, so to speak:⁹

⁸. Gupta (1986,36fn2) explicitly proposes that a Hindi correlative like (i) derives from an externally headed RC like (ii), with deletion of the external Head (also see Mahajan 2000,215):

- (i) jo laRka: la:l kami:j pahne hai wo mera: bha:i: hai
 which boy red shirt wearing is that/he I.gen brother is
 ‘The boy who is wearing a red shirt is my brother’

- (ii) [[wo laRka:] [jo laRka: la:l kami:j pahne hai]] wo mera: bha:i: hai
 That boy which boy red shirt wearing is that/he I.gen brother is

Junghare (1973) also proposes to derive the Marathi correlative forms in (iii) from a structure essentially like (iv), which however is not acceptable for her. Also see Wali (1982):

- (iii) a. **to manus** [jo Ø ithð kam kðrto] **to manus** ajari ahe
 b. **to** Ø [jo Ø ithð kam kðrto] **to** Ø ajari ahe
 c. **to** Ø [jo Ø ithð kam kðrto] **to manus** ajari ahe
 d. Ø Ø [jo **manus** ithð kam kðrto] **to** Ø ajari ahe
 e. Ø Ø [jo Ø ithð kam kðrto] **to manus** ajari ahe
 f. Ø Ø [Ø Ø ithð kam kðrto] **to manus** ajari ahe
 (that)(man)(which)(man) here work does that (man) sick is
 ‘the man who works here is sick’

- (iv) **to manus** [jo **manus** ithð kam kðrto] **to manus** ajari ahe (*)

- (8) vo laRkii jo laRkii khaRii hai, vo laRkii lambii hai
 that girl which girl standing be-PR, that girl tall be-PR
 ‘the girl who is standing, that girl is tall’

The same full structure is apparently acceptable (under the appropriate conditions of emphasis) in two other Indo-Aryan languages: Bundeli ((9)a – Ruchi Jain, p.c.) and Maithili ((9)b, from Singh (1980), according to whom it is “cumbersome, though acceptable”(p.34)):¹⁰

- (9) a. [**ba moRii** [**jo moRii** ThaRii hε]], **ba moRii** lambii hε
 that girl which girl standing is, that girl tall is
 ‘The girl who is standing is tall’
- b. [(**o**) **panc-sab** [**jaahⁱ** **panc-sab-kEⁿ** ham niik jakaanⁿ janait chalianhⁱ]_S]_{NP} **o**
panc-sab..
 (the) Panch which Panch-PL-OBJ I good way know.PART BE.PAST.AGR, the
 (same) Panch..
 ‘The Panch whom I knew very well, the same Panch...’

The ‘left dislocated’ DP, containing the RC, is matched by a resumptive DP (often pronominal/ demonstrative) in the clause. Depending on the language, the ‘left dislocated’ DP containing the correlative clause may apparently be either an English-type Left dislocation/Hanging Topic (Kashmiri), or a German-type Contrastive Left Dislocation (German, Bulgarian), or a Romance-type Clitic Left Dislocation (for the “correlatives” of Italian).

As opposed to the other Indo-Aryan languages, Kashmiri is an (SOV) V-2 language. Its finite verb, in main (and complement) clauses, necessarily occupies the second position, following either the subject or a scene-setting adverb, or a focussed phrase or wh-phrase

⁹. Alice Davison tells me that (8) was accepted by many speakers she consulted. Wali (2006,289) claims that in Marathi too the left dislocated DP may sometimes surface unreduced. See (v) (Renuka Ozarkar tells me that this is indeed possible if one wants to emphasize ‘that particular girl’, stressing ‘ti’ at the beginning of the main clause. Otherwise, it is slightly odd (?)):

- (v) **Ti mulgi** [**ji mulgi** ghari geli] ti ithe rāhte
That girl which girl home went that here lives ‘The girl who went home lives here’

¹⁰. The same full structure is instead not readily acceptable in Nepali (Samar Sinha, p.c.).

(Hook and Koul 1996, and especially Bhatt 1999, chapter 4).¹¹ However, if a left dislocated/hanging topic is present, resumed by a demonstrative or pronominal inside the clause, the finite verb is found in *third* position, with a subject or a focussed/wh-phrase occupying the second position. In other words, the left dislocated/hanging topic phrase does not count as a filler for the “first position”.¹²

Now, as Hook and Koul (1996,98) show, a correlative clause too “does not count in the V-2 calculation, with the result that the finite verbal element comes in *third* position”. See (10)a, which contrasts minimally with (10)b, characterized by a topicalized Headed postnominal relative (not resumed by a correlative element):

- (10) a. [yus naphar raath aay] bi chus yatshaan temyis samikh-un
 [which person yesterday came] I am wanting him.DAT meet-INF
 ‘I want to meet the man who came here yesterday’
 b. [temyis naphras yus raath aav] chus bi yatshaan samikh-un
 [the person who yesterday came] am I wanting meet-INF
 ‘I want to meet the man who came here yesterday’

¹¹. As Richard Kayne reminds me, Kashmiri, as opposed to Germanic V-2 languages, allows multiple wh-fronting, with the consequence that the verb may end up not being in strict second position. It also ends up in third position after a Hanging Topic (see the next footnote), or in the presence of a sentence initial yes/no question marker (Koul 2003, §6.2.1.4). Also see Bhatt (1999, §4.1.2.2).

¹². See for example (i)a-b, from Bhatt (1999,103):

- (i) a. Tem dop ki, coon kalam, shiilaayi tshooND su
 he said that, your pen, Sheila found that
 ‘He said that as for your pen, it is Sheila who found it’
 b. Coon kalam, su goyi me garyi mashith
 your pen, that gone I home-at forget
 ‘As for your pen, that (is what) I forgot at home’

Bhatt (1999,103f) gives two arguments for the extra-clausal nature of left dislocated/hanging topics in Kashmiri. The first is that it is possible to insert a parenthetical after them, and the second is that they are “always in the nominative case”, whereas the co-referential pronoun in the following clause is in the appropriate Case.

Thus Kashmiri provides direct evidence that one type of correlative clause can occupy the position of left dislocated/hanging topics, preceding the CP space which contains a fronted phrase (in first position) and the finite verb (in second position).¹³

Hindi, possibly in addition to an English/Kashmiri-type left dislocation construction (Dwivedi 1994a, section 2.2.2), appears to have a topicalization construction involving movement, possibly similar to Romance Clitic Left Dislocation, modulo the presence of non clitic resumptive DP (either a full DP, or a demonstrative pronoun) (Mahajan 1990; Srivastav 1991; Dwivedi 1994a,b). See, in particular Mahajan (2000,fn.10) and Bhatt (2003) for arguments that the correlative relative acquires its left adjoined position by movement, and Bhatt (2003) for the idea that it starts out together with the correlative pronoun (as seen from the possibility of their making up a constituent), and optionally moves out to a left peripheral position stranding the correlative DP.

We follow this analysis here except for the idea that the RC is internal to a DP which together with the correlative DP forms a “big DP” ([[Head RC] [correlative]], much like the “big DP” taken to underlie French Complex Inversion (Kayne 1972) and Romance Clitic Left Dislocation ([_{DP} DP [_DClitic]] – Uriagereka 1995,81).

In Bulgarian, differently from Hindi (and other Indo-Aryan languages), the left dislocated DP of the correlative construction is never found adjoined to the resumptive element (Bhatt 2003,529). Rather, it appears to be base generated in situ and matched by a correlative element which obligatorily moves to the front of the main clause (presumably to Spec,FocusP) (cf. Izvorski 1996,12):

¹³. If the left dislocated phrase containing the relative clause in Kashmiri is base generated in the left peripheral position rather than moved there, no reconstruction of the left dislocated DP should be possible, nor should its relation with the correlative element be subject to island constraints. This remains to be checked.

Hungarian correlatives, which, as Lipták (2004) shows, do not reconstruct inside the main clause to a position adjoined to the correlative element, nor display sensitivity to islands, also appear (pace her own conclusion) to be Hanging Topics. The two putative differences which according to Lipták (2004, 302) distinguish Hanging Topics from Hungarian correlatives may turn out not to be real. Both correlatives and Hanging Topics seem to be root phenomena and indeed, just as with correlatives, there is in general no more than one Hanging Topic per clause (cf. Postal 1971, 136, fn.17; Cinque 1990,58; although some speakers marginally accept more than one).

- (11) [Kolkoto pari Maria_k iska], tolkova_i tja_k misli če šte j dam t_i
 How much money M. wants, that much she thinks that will her I.give
 ‘She thinks that I will give her as much money as Maria wants’

This is indicated by the fact that, differently from Hindi (Bhatt 2003, section 3.3.1), the left dislocated DP (in (11)) does not reconstruct, as no Principle C violation is to be observed there.

This appears parallel to the non-connectivity variant of German contrastive Left Dislocation:¹⁴

- (12) [Wer das sagen wird] dem will ich vertrauen
 who.NOM that say will that.DAT will I trust
 ‘I will trust who(ever) says that’

In Italian, the element resuming the “correlative” relative is normally a run-of-the-mill clitic, actually the usual resumptive clitic associated with the Clitic Left Dislocated DP that contains the relative clause (though a demonstrative, itself clitic left dislocated, can resume the correlative relative when this is a hanging topic, as in (13)c):

- (13) a. **Qualunque promessa** lui potrà farti, non prenderla sul serio
 whatever promise he will.be.able.to make to you, not take it seriously
 ‘Whatever promise he may make to you, do not take it seriously’
 b. **Chi fa cose del genere**, credo Ø non debba essere seguito
 who does such things, I.think not has to be followed
 ‘I do not think that one should follow someone who does such things’
 c. **Chi ti ha appena telefonato, quello lì**, proprio non lo sopporto
 Who to you has just telephoned , that there really not him I.can.stand
 ‘The one who just called you, that one really I cannot stand’

¹⁴. Namely to (i)a, where no Case connectivity is present, vs. (i)b:

- (i) a. Der Karl, dem will ich vertrauen
 The(Nom) Karl, him(Dat) will I trust
 b. Dem Karl, dem will ich vertrauen
 The(Dat) Karl, him(Dat) will I trust

From this perspective, the impossibility of stacking correlatives (Srivastav 1996,175-77; McCawley 2004, section 5; Butt, King and Roth 2007, section 2) should be limited to those containing a left dislocated free relative (as free relatives are also known not to be able to stack – Carlson 1977).¹⁵ It should not extend to those correlatives that contain a left dislocated externally headed (pre- or post-nominal) relative clause, or an internally headed one whose Head has not moved, all of which are known to be able to stack. In the next Note I am actually suggesting that all main types of relative clauses can be left dislocated, and thus enter the correlative construction. To reserve the term ‘correlative’ just to left dislocated free relatives seems, from this point of view, arbitrarily limiting.

NOTE 2: (Simple) Correlatives as a non independent relative clause type

It is often assumed, in both the typological and generative literature, that correlatives are an entirely separate type of relative clause, but if they are DPs (containing a relative clause) in TopP, resumed by a coindexed resumptive phrase in the matrix IP, then one should expect them to be just a particular manifestation of externally headed postnominal, externally headed prenominal, internally headed, and “headless” (or “free”) relative clauses, not an independent, fifth, type.

This indeed seems to be the case as the ‘left dislocated’ DP can contain, depending on the language, any of the other types of relatives. We have already seen that it can

¹⁵. Stacking of correlatives is claimed to be possible in other Indo-Aryan languages: Konkani (Almeida 1989,304 - see (i)), and Bhojpuri (Shukla 1981, chapter 19, section 4, p.206 – see (ii)):

- (i) jo a:j aila, ja-ka g^hor na, jace poise sādlyat, tya mons-ak pedru adar dita
 who today come, who-dat house not, whose money lost, that man-dat Peter help gives
 ‘Peter helps the man who has come today, who has no home and whose money is lost’
- (ii) ham jaon p^hal pa:k-i:, jaon tu: bec-ba: taon k^ha:-b
 I which fruit ripe-3sg.m.fut, which you sell-2sg.m.fut that eat-1sg.fut
 ‘I will eat that fruit, which will ripen, which you will sell’

Also see Davison (2009, section 2.2.5) for the apparent possibility of stacking in Sanskrit correlatives. However, given that the impossibility of stacking seems to be a general property of relatives involving raising of the internal Head (free relatives, correlatives with a left peripheral free relative, etc. - Carlson 1977; Grosu 2002), one should determine whether such cases truly involve stacking rather than simple asyndetic coordination (cf. McCawley 2004,306).

contain an externally headed postnominal relative clause (see (5)), or a “headless”/”free” relative clause (see (3) and the Bulgarian, German, and Italian examples in (11) through (13)). It can also contain an externally headed prenominal relative clause resumed by a coindexed phrase in the matrix IP, as shown by the Sinhala (Indo-Aryan) example in (14):¹⁶

- (14) [ara [hitagena inna] gaenu lamaya], ee lamaya usa i
 that [standing being] woman child, that child tall is
 ‘That girl who is standing, that girl is tall.’

Finally, the ‘left dislocated’ DP can also contain an Internally Headed relative clause resumed by a coindexed phrase in the matrix IP, as in the Wappo example (15), or in the Bambara example (16):¹⁷

¹⁶. I owe this example to Lalith Ananda (p.c.). The phonetic transcription follows the one utilized in Ananda (2008).

Sinhala is generally reported (Bhatt 2003,491; Leung 2007c; Lipták 2009a,10) as not having correlatives (as it does not have embedded postnominal relative clauses with relative pronouns, nor their free relative variant). But, if correlatives are not limited to left dislocated free relatives, this is strictly speaking not true.

Languages with both correlatives and prenominal relative clauses have been claimed (Downing 1978,400) not to exist. But, in addition to the case of Sinhala, Dravidian languages and the language isolate Burushaski also have both correlatives and prenominal relative clauses, even though, differently from Sinhala, for correlatives they utilize a free relative (containing an interrogative adjective/pronoun) resumed by a correlative proform (cf. Lakshmi Bai 1985 for Dravidian, and Tiffou and Patry 1995 for Burushaski).

¹⁷. Cf. Keenan (1985,165). Other languages optionally displaying a left dislocated DP with an Internally Headed relative clause resumed by a phrase in the matrix IP are Arizona Tewa (Gorbett 1977,272), and, possibly, Italian Sign Language (Branchini and Donati 2009), which also appears to have externally Headed postnominal relative clauses (also entering a correlative construction). See Bertone (2006), and Brunelli (2006).

- (15) [i čhuya t'um-ta] cephi šoy'i-khi? (Thompson, Park, and Li 2006,117)¹⁸
 1SG house buy-PST:DEP 3SG:NOM burn-STAT
 I house bought, that one burned down = ‘the house I bought burned down’

- (16) deni mi djolen file, o (deni) ka djan (Dayal 1996,215fn.15)¹⁹
 girl which is standing, that (girl) is tall
 ‘Which girl is standing, that (girl) is tall’

NOTE 3: Multiple correlatives as non-relative, free adjunct, CPs.

In addition to the possibility for simple, but not for multiple, correlatives to alternate with externally headed postnominal relatives, there is further evidence that one should distinguish between two separate constructions: one, a DP (containing a relative CP), adjoined to the resumptive correlative DP, which it can strand in its movement to the left-periphery of the matrix IP (as shown in (17)a); the other, a base-generated CP, containing one or more wh-phrases, paired in the matrix IP with corresponding

¹⁸. Wappo (a Californian language whose genetic affiliation is unclear - Thompson, Park and Li 2006, xi) also has free relatives resumed by a demonstrative correlative pronoun:

- (i) [te ita čo?-me] cew ah te-k'a čo:-si? (Thompson, Park and Li 2006,123)
 3SG where go-DUR:DEP there 1SG:NOM 3SG-COM go-FUT
 ‘I’ll go wherever s/he goes’

Thompson, Park and Li (2006) say that “[t]he demonstrative pronoun seems to be required when it is *cephi*, the nominative form, but optional when it is *ce*, the accusative form” (p.116).

¹⁹. Bambara (of the Mande branch of Niger-Congo) has both left peripheral Internally Headed relative clauses resumed by an anaphoric phrase/pronoun ((16)), or Internally Headed relative clauses in argument position, as in (i), below (in both cases the internal Head is marked by a following modifier, *mi(n)*). In some varieties it also has externally headed postnominal and extraposed relative clauses (Bird 1968, Zribi-Hertz and Hanne 1995, and references cited there).

- (i) Tyε` ` be n ye so min ye dyo (Bird 1968,46)
 man the PRES [I PAST house wh- see] erect
 ‘The man is building the house that I saw’

correlative phrases, as in (17)b (cf. Izvorski 2000. I exemplify with English glosses only):

(17) a. ‘Ram, which CD is on sale, that CD bought’

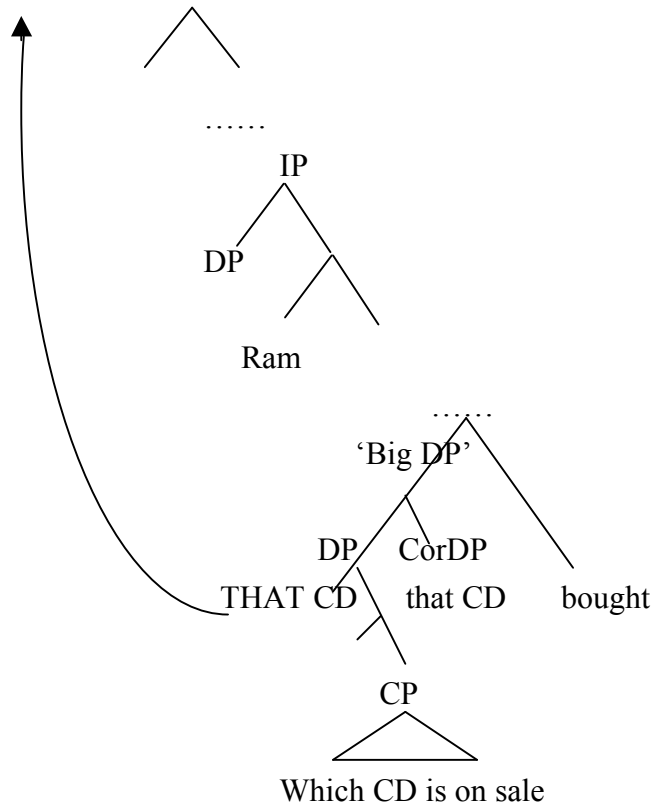

b. ‘Which girl which CD heard, that girl that CD bought’

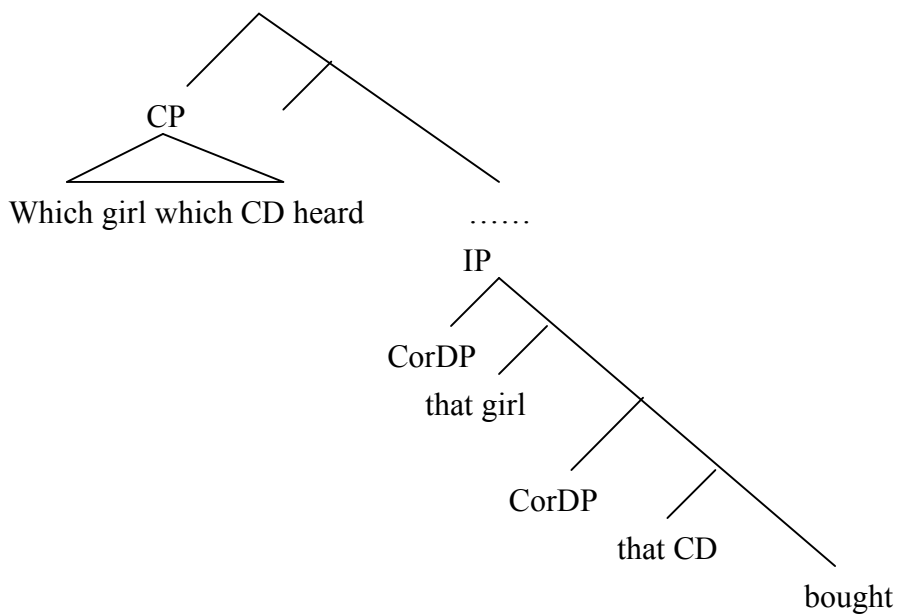

As shown most extensively in Bhatt (2003, 2005), this dual analysis receives support from the fact that in simple, but not in multiple, correlatives the relation between the relative clause and the correlative pronoun is sensitive to islands (Dayal 1996,183; Mahajan 2000, fn.10, and Bhatt 2005); and from the fact that in simple, but not in multiple, correlatives there is obligatory reconstruction of the fronted relative clause, as evidenced by pronominal binding facts and Principle C violations. For exemplification, see Bhatt (2003,section 3.3.3; 2005).²⁰

²⁰. Anderson (2005) makes the interesting observation that Nepali shows a semantic distinction between the two structures (17)a and b. The former is associated with a restrictive (specific) interpretation, the latter with an indefinite (free choice) interpretation. The evidence for this comes from the fact when the correlative is in absolute initial position both interpretations are available while only one, the restrictive (specific) interpretation, is possible when the correlative is adjacent to the correlative pronoun. See (i)a and b:

- (i) a. jun manche-lai bhok lag-eko cha, ma us-lai khana din-chu (Anderson's 2005, ex. (15))
 REL man-DAT hunger attach-PFPT 3SG.PR, 1SG.NOM 3SG.DAT food give-1SG.PR
 either: 'I will give food to the man who is hungry' (specific man – restrictive relative)
 or: 'I will give food to any man who is hungry' (any hungry man – free relative)
- b. ma jun manche-lai bhok lag-eko cha, tyo manche-lai khana din-chu (Anderson's 2005, ex. (16))
 1SG.NOM REL man-DAT hunger attach-PFPT 3SG.PR, DEM man-DAT food give-1SG.PR
 'I will give food to the man who is hungry' (specific man)

This makes sense, according to Anderson (2005), if the initial position can either be filled by movement of the correlative relative from the internal position adjacent to the correlative DP (which gives the restrictive, specific, interpretation) or by base generating the simple correlative CP (like multiple correlatives) in initial position (which gives the free choice interpretation). It remains to be seen whether this holds of other Indo-Aryan languages as well. Dayal (1996, chapter 6, section 2) suggests that multiple correlatives in Hindi have a functional reading, which apparently “can also be used to refer to a unique pair of individuals in the contextual domain.” (p.204). Additionally, it should be observed that if simple correlatives can also access the base generated structure of multiple correlatives, they would be expected to show no necessary island sensitivity nor obligatory reconstruction. The facts here are contradictory. While Mahajan (2000,227fn10) and Bhatt (2003, 2005) claim that the correlative pronoun cannot be found within an island (see (ii)), McCawley (2004) gives one case of a correlative pronoun within a relative clause complex NP island judged possible by his informants (his orthography has been uniformized to the one used here). See (iii):

A further difference between multiple and simple correlatives is represented by the possibility of ‘deleting’ correlative pronouns when the relative phrases have overt Case. As noted in Bhatt (1997), who attributes the observation to Veneeta Dayal, this is possible in multiple correlatives ((18)) but not in simple correlatives ((19)) (also see Bhatt 2003, section 4):

(18) [jis_i ne jo_j chahaa] (us_i ne vo_j) kiyaa ((24) of Bhatt 1997,64)
 REL.obl ERG REL want.Pfv DEM.obl ERG DEM do.Pfv
 ‘Whoever whatever wanted, they did that’

(19) [jis laRkii=ko Srini pasand hai] *(vo) khaRii hai ((9)b of Bhatt 1997,57)
 REL.obl girl=DAT S. like be.PRS DEM standing be.PRS
 ‘The girl who likes Srini is standing’

That simple and multiple correlatives should not be treated as a homogeneous construction is also shown by the fact that not all languages having correlatives allow for multiple correlatives. This is the case of Bambara, as reported in Pollard and Sag (1994,229,fn.10) and that of Basque, as reported in Rebuschi (1999,59).

(ii) *[jo si:ta:-ko acha: lagta: hε] mε [DP yah ba:t [CPki vo a:dmi: pa:gal hε]]

((ii) ofn.10 of Mahajan 2000)

who Sita-DAT nice seem be-PRES I this fact that that man crazy be-PRES know be-PRES
 ‘I know the fact that the man who Sita likes is crazy’

(iii) [jo laRkii vaha khaRii hai], ram ne vo paRha, jo us ne likha
 Which girl there standing is, Ram read the letter that she wrote

Further investigation is needed here, also in relation to the apparent possibility of extracting from correlatives (and *if* clauses) vs. the impossibility of extracting from embedded postnominal and extraposed relatives reported in Dwivedi (1994a,b). Perhaps extraction is possible from the adjunct CP correlative but not from the DP correlative.

NOTE 4: Non-restrictive correlatives

Dayal (1996), on the basis of the ungrammaticality of examples like (20) below, concludes that Hindi correlatives cannot be non-restrictive “since non-restrictives typically occur with proper names” (p.182).²¹

- (20) *jo laRkii khaRii hai anu lambii hai (= ex. (43) of Dayal 1996,182)
 which girl standing be-PR Anu tall is
 ‘Anu, who is standing, is tall’

The question remains whether this is a property of Hindi or of correlatives more generally. To judge from the fact that the closely related Indo-Aryan language Marathi can apparently form non-restrictive correlatives, one has to conclude that the impossibility of (20) in Hindi is not due to some inherent feature of the correlative construction, but is a property of the grammar of Hindi (to be understood). The possibility of non-restrictive correlatives in “rhetorical speech and writing” in Marathi is noted in Gupte (1975,77), where such examples as (21)a-b are reported (also see Pandharipande 1997,82f).²²

- (21) a. jā-nni gāṭ^hā racali te tukārām mahārāj dehulā janmale
 REL-INSTR Gatha composed that St.Tukaram Dehu-at was born
 ‘St.Tukaram, who composed the Gatha, was born in Dehu’

²¹. Also see Gupta (1986,34). The same is claimed by Butt, King and Roth (2007, section 4.2) for the Urdu variant of Hindi/Urdu, and by Bhatia (1993,55) for Punjabi.

²². The existence of non-restrictive correlatives in Marathi was independently pointed out to me by Avinash Pandey and Renuka Ozarkar. Renuka Ozarkar gave me the following additional example of a non-restrictive correlative in Marathi:

- (i) ji-ne maajhyaa-saaThii kaSTa ghet-l-e, tii maajhii aaii aataa jiwanta naahii.
 REL.fem-ERG me-for efforts take-PERF-3P.PLURAL, that my-FEM mother now alive not-PRES
 ‘My mother, who took efforts for me, is not alive anymore.’

Non-restrictive correlatives were apparently also possible in Sanskrit. See Davison (2009,227).

- b. gānd^hi-nni jā-nnā guru mānale te gok^hale mawāl hote
 Gandhi-INSTR REL-to teacher regarded that Gokhale moderate was
 ‘Gokhale, whom Gandhi regarded as (his) teacher, was a moderate’

As a matter of fact, given the possibility of resuming a DP followed by a non-restrictive relative clause with a correlative phrase, as in (22) from Bangla, it should in principle be possible, if the language permits it, to ‘delete’ the external Head like is possible with the external Head of restrictives (cf. (3) and (5) above):

- (22) bhoddrolok, Jini amar āttio, tini bose achen (Morshed 1986,38)
 Gentleman, who my relative, he sitting is
 ‘The gentleman, who is my relative, is sitting’

Thus the possibility of non-restrictive correlatives may simply reduce to whether the language allows deletion of the external Head of non-restrictives (Marathi) or not (Hindi).

Interestingly, non-restrictive correlatives are also attested in other language families. See (23) from Jalonke (of the Central Mande branch of Niger-Congo), and the relative discussion in Lüpke (2005,131f):

- (23) N naaxan a fala-m’ i be jεε, n saa-xi saar-εε ma
 1SG REL 3SG speak-IPFV 2SG for PART, 1SG lie-PF bed-DEF at
 (lit.) which I is speaking to you now, I lie in bed
 I, who am talking to you now, I am lying on the bed.’

NOTE 5: Correlatives as a non exclusive relativization strategy.

To judge from the substantive lists of languages with correlatives given in de Vries (2002,388 and 412), Bhatt (2003,491), and Lipták (2009a,10f) it seems that there may be no single language for which correlatives are the only relativization strategy available. Correlatives invariably appear to co-occur either with embedded postnominal or extraposed relatives (most Indo-Aryan languages, Slavic languages, Warlpiri, etc.), or with prenominal non finite relatives (Dravidian languages, Sinhala, etc.), or with internally Headed relatives (Bambara, Wappo, etc.). From what I have been able to see

in the literature on relative clauses, no language is described as having correlatives as its only type of relative clause.²³

This fact (assuming it to be a fact) should actually not be surprising if one thinks that simple correlatives (setting multiple correlatives aside, which are no relative clauses) are just left dislocated DPs containing a relative clause of one or another of the existing types (externally Headed postnominal, externally Headed prenominal, internally Headed, and Headless or free) resumed by a phrase in the main clause.

References

- Almeida, Matthew, S.J. 1989. *A Description of Konkani*. Panaji: Thomas Stephens Konknni Kendr.
- Ananda, Lalith M.G. 2008. *The Cleft Construction in Sinhala*. MPhil. Dissertation. Jawaharlal Nehru University, New Delhi.
- Anderson, Corinna. 2005. “Two Types of Nepali Correlatives”. In Y.Yadava, G.Bhattarai, R.R. Lohani, B.Prasain and K. Parajuli (eds.), *Contemporary Issues in Nepalese Linguistics*. 1-12. Kathmandu: Linguistic Society of Nepal.
- Andrews, Avery D. 1975. *Studies in the Syntax of Relative and Comparative Clauses*. Ph.D.thesis, Massachusetts Institute of Technology.

²³ Actually, Creissels (2009,43) states that “[l]e malinké n’a pas de relatives adnominales: les seules relatives du malinké sont les relatives corrélatives [...]”, but, as he makes clear, the correlatives of Malinké are left dislocated Internally Headed relatives, which in contrast to the closely related language Bambara (cf. fn.19 above), appear not to be able to occur in argument position (Creissels 2009,51). This, if true, remains to be understood.

- Bagchi, Tista. 1994. "Bangla correlative pronouns, relative clause order and D-linking". In M. Butt et al. (eds), *Theoretical Perspectives on Word Order in South Asian Languages* (CSLI Lecture Notes 50) 13–30. Stanford, CA: CSLI.
- Bertone, Carmela. 2006. *La struttura del sintagma determinante nella Lingua dei Segni Italiana (LIS)*. Ph.D. Dissertation, University of Venice.
([http://dspace-unive.cilea.it/handle/10278/89/items-by_author?author= Bertone%2C +Carmela](http://dspace-unive.cilea.it/handle/10278/89/items-by_author?author=Bertone%2C+Carmela)).
- Bhatia, Tej K. 1993. *Punjabi*. London: Routledge.
- Bhatt, Rajesh. 1997. "Matching effects and the syntax–morphology interface: evidence from Hindi correlative"s. In B. Bruening (ed.), *Proceedings of SCIL 8* (MIT Working Papers in Linguistics 31) 53–68. Cambridge, MA: MITWPL.
- Bhatt, Rajesh. 2003. "Locality in Correlatives". *Natural Language and Linguistic Theory* 21.485-541.
- Bhatt, Rajesh. 2005. "Correlative Clauses". Handout of a course at the 2005 LOT Summer School, Leiden (June 16).
(<http://people.umass.edu/bhatt/752-s05/n44.pdf>).
- Bhatt, Rakesh Mohan. 1999. *Verb Movement and the Syntax of Kashmiri*. Dordrecht: Kluwer.
- Bianchi, Valentina. 1999. *Consequences of Antisymmetry: Headed Relative Clauses*. Berlin: Mouton de Gruyter.
- Bird, Charles B. 1968. "Relative Clauses in Bambara". *The Journal of West African Languages* 5.35-47.
- Branchini, Chiara and Caterina Donati. 2009. "Relatively different. Italian Sign Language relative clauses in a typological perspective". In A. Lipták (ed.), *Correlatives Cross-Linguistically*. 157-191. Amsterdam: Benjamins.
- Brunelli, Michele. 2006. *The grammar of Italian Sign Language, with a study about its restrictive relative clauses*. MA Thesis, University of Venice.
(<http://michelebrunelli.interfree.it/LISgrammRestrRel.html>).
- Butt, Miriam, Tracy Holloway King, and Sebastian Roth. 2007. "Urdu Correlatives: Theoretical and Implementational Issues". In M. Butt and T. Holloway King (eds.), *Proceedings of the LFG07 Conference*. Stanford: CSLI Publications
(<http://csli-publications.stanford.edu/LFG/12/lfg07.pdf>).
- Cable, Seth. 2007. "The Syntax of the Tibetan Correlative". Manuscript. University of British Columbia. Vancouver, BC.
(<http://people.umass.edu/scable/papers/Tibetan-Correlative-Syntax.pdf>).
(appeared in A.Liptak 2009b).

- Carlson, Greg N. 1977. "Amount Relatives". *Language* 53, 520–542.
- Cecchetto, Carlo, Carlo Geraci and Sandro Zucchi. 2006. "Strategies of relativization in Italian Sign Language". *Natural Language and Linguistic Theory* 24.945-975.
- Cinque, Guglielmo. 1990. *Types of A-Bar Dependencies*. Cambridge, Mass.: MIT Press.
- Cinque, Guglielmo. 2008. "More on the indefinite character of the Head of restrictive relatives". In P.Beninca, F.Damonte and N.Penello (eds.), *Selected Proceedings of the 34th Incontro di Grammatica Generativa*. Unipress, Padova (Special issue of the *Rivista di grammatica generativa*, vol. 33, 3-24.
(<http://dspace-unive.cilea.it/handle/10278/880>).
- Cinque, Guglielmo. 2009. "The Fundamental Left-Right Asymmetry of Natural Languages". In S. Scalise, E. Magni, A. Bisetto (eds.), *Universals of Language Today*. Dordrecht: Springer (2009), pp. 165-184.
(<http://dspace-unive.cilea.it/handle/10278/214>).
- Cinque, Guglielmo. In preparation. *A unified analysis of relative clauses*. University of Venice.
- Creissels, Denis. 2009. "Les relatives corrélatives: le cas du malinké de Kita". *Langages* 174.39-52.
- Dasgupta, Probal. 1980. *Questions and relative and complement clauses in a Bangla grammar*. Ph.D. Dissertation. New York University.
- Dasgupta, Probal. 2006. "Unifying relativization and control in Bangla". In M. Banerjee et al. (eds.), *Nyaya-Vasistha: Felicitation Volume of Professor V.N. Jha*. 138-170. Kolkata: Sanskrit Pustak Bhandar.
- Davison, Alice. 2009. "Adjunction, features and locality in Sanskrit and Hindi/Urdu correlatives". In A. Lipták (ed.), *Correlatives Cross-Linguistically*. 223-262. Amsterdam: Benjamins.
- Dayal, Veneeta. 1996. *Locality in wh-Quantification*. Dordrecht: Kluwer.
- Downing, Bruce T. 1973. "Correlative relative clauses in universal grammar". *Minnesota Working Papers in Linguistics and Philosophy of Language* 2.1-17.
- Downing, Bruce T. 1978. "Some Universals of Relative Clause Structure". In J.Greenberg (ed.), *Universals of Human Language*. Vol.4. 375-418. Stanford, CA: Stanford University Press.
- Dwivedi, Veena. 1994a. "Topicalization in Hindi and the Correlative Construction". In M. Butt, T. Holloway King and G. Ramchand (eds.), *Theoretical Perspectives on Word Order in South Asian Languages*. 91-118. Stanford: CSLI Publications.
- Dwivedi, Veena. 1994b. *Syntactic Dependencies and Relative Phrases in Hindi*. Ph.D. Dissertation, University of Massachusetts, Amherst.

- Gorbet, Larry. 1977. "Headless relative clauses in the southwest: are they related?" *BLS* 3.270-78.
- Grosu, Alexander. 2002. "Strange relatives at the interface of two millennia". *Glott International* 6.6.145-167.
- Gupta, Sagarmal. 1986. *Discourse Grammar of Hindi. A Study in Relative Clauses*. New Delhi: Bahri Publications Private Limited.
- Gupte, Sharad M. 1975. *Relative Constructions in Marathi*. Ph.D. Dissertation, Michigan State University.
- Hale, Kenneth. 1976. "The adjoined relative clause in Australia". In R. M. W. Dixon (ed.), *Grammatical Categories in Australian Languages*. 78-105. Canberra: AIAS
- Hook, Peter Edwin and Omkar Nath Koul. 1996. "Kashmiri as a V-2 language". In V. Swarajya Lakshmi and A. Mukherjee (eds.), *Word Order in Indian Languages*. 95-105. Hyderabad: Center for Advanced Study in Linguistics, Osmania University and Booklinks Corporation.
- Izvorski, Roumyana (Pancheva). 1996. „The syntax and semantics of correlative proforms". *NELS* 26.133-147.
- Izvorski, Roumyana (Pancheva). 2000. "Free Adjunct Free Relatives". *Proceedings of WCCFL* 19.232-245.
- Junghare, Indira. 1973. "Restrictive Relative Clauses in Marathi". *Indian Linguistics* 34.4.251-262.
- Kayne, Richard S. 1972. "Subject inversion in French interrogatives". In J. Casagrande and B. Saciuk (eds.), *Studies in Romance Languages*. 70-126. Newbury House, Rowley, Mass.
- Kayne, Richard S. 1994. *The Antisymmetry of Syntax*. Cambridge, Mass.: MIT Press.
- Kayne, Richard S. 2004. "Here and There". In C. Leclère, É. Laporte, M. Piot, M. Silberstein (eds.), *Lexique, Syntaxe et Lexique-grammaire. Syntax, Lexis & Lexicon-Grammar. Papers in Honour of Maurice Gross*, 275-285. Amsterdam: Benjamins (also in Kayne 2005b, pp.65-84).
- Kayne, Richard S. 2005a. "Some Notes on Comparative Syntax, with Special Reference to English and French". In G. Cinque and R.S. Kayne (eds.), *The Oxford Handbook of Comparative Syntax*, 3-69. New York: Oxford University Press (also in Kayne 2005b, pp. 277-333).
- Kayne, Richard S. 2005b. *Movement and Silence*. New York: Oxford University Press.
- Kayne, Richard S. 2007. "On the Syntax of Quantity in English". In J. Bayer, T. Bhattacharya and M.T. Hany Babu (eds.), *Linguistic Theory and South Asian*

- Languages. Essays in honour of K.A.Jayaseelan*. 73-105. Amsterdam: Benjamins (also in Kayne 2005b, pp.176-214).
- Keenan, Edward. 1985. "Relative Clauses". In T. Shopen (ed.), *Language Typology and Syntactic Description*. Vol.II. *Complex Constructions*. 141-170. Cambridge: Cambridge University Press.
- Koul, Omkar N. 2003. "Kashmiri". In G. Cardona and D. Jain (eds.), *The Indo-Aryan Languages*. 895-952. London: Routledge.
- Krapova, Iliyana. 2009. "Bulgarian Relative and Factive Clauses with an Invariant Complementizer". Ms., University of Venice. To appear in *Lingua*.
(<http://lear.unive.it/handle/10278/1180>)
- Lakshmi Bai, B. 1985. "Some notes on correlative constructions in Dravidian". In V. Z. Acson and R. L. Leed (eds.) *For Gordon H. Fairbanks*. 181-90. Honolulu: University of Hawaii Press.
- Leung, Tommi T.-C. 2007a. *Syntactic Derivation and the Theory of Matching Contextual Features*. Ph.D. Dissertation, University of Southern California.
- Leung, Tommi T.-C. 2007b. "Correlatives and the conditions on chain formation" *Proceedings of the International Conference on Linguistics in Korea (ICLK 2007)*, Seoul National University, Seoul, KGGC.
(<http://tommi.leung.googlepages.com/ICLK2007-handout.pdf>)
- Leung, Tommi T.-C. 2007c. "On the Typology of Correlative Constructions". Handout of a paper presented at the conference of the Association of Linguistic Typology (ALT VII) CNRS, Paris, France.
(<http://tommi.leung.googlepages.com/ALTVIIhandout.pdf>)
- Lipták, Anikó. 2004. "On the Correlative Nature of Hungarian Left-peripheral Relatives". In B. Shaer, W. Frey, C. Maienborn (eds), *Proceedings of the Dislocated Elements Workshop (ZAS Berlin; November 2003)*, *ZAS Papers in Linguistics* 35.1: 287-313. Berlin: ZAS.
- Lipták, Anikó. 2009a. "The landscape of correlatives: An empirical and analytical survey". In A. Lipták (ed.), 2009b. 1-46.
- Lipták, Anikó, (ed.). 2009b. *Correlatives Cross-Linguistically*. Amsterdam: Benjamins.
- Lüpke, Friederike. 2005. *A Grammar of Jalonke Argument Structure*. Ph.D. Dissertation, Radboud Universiteit, Nijmegen (Vol.30 of the Max Planck Institute in Psycholinguistics Series) (<http://repository.ubn.ru.nl/handle/2066/19598> or <https://eprints.soas.ac.uk/4853/1/gramofjaa.pdf>).

- Mahajan, Anoop. 2000. "Relative Asymmetries and Hindi Correlatives". In A. Alexiadou, P. Law, A. Meinunger, C. Wilder (eds.), *The Syntax of Relative Clauses*. 201-229. Amsterdam: Benjamins
- McCawley, James D. 2004. "Remarks on Adsentential, Adnominal and Extraposed Relative Clauses in Hindi". In V. Dayal and A. Mahajan (eds.), *Clause Structure in South Asian Languages*. 291-311. Dordrecht: Kluwer.
- Milsark, Gary. 1974. *Existential sentences in English*. Ph.D. Dissertation, MIT.
- Morshed, Abul K.M. 1986. *Relativization in Bengali*. Dhaka (Bangladesh): University of Dhaka (originally a dissertation from the University of Edinburgh).
- Neukom Lukas and Manideepa Patnaik. 2003. *A grammar of Oriya* (ASAS, Nr.17). Zürich: Seminar für Allgemeine Sprachwissenschaft, Universität Zürich.
- Pandharipande, Rajeshwari V. 1997. *Marathi*. London: Routledge.
- Pollard, Carl and Ivan A. Sag. 1994. *Head-Driven Phrase Structure Grammar*. Chicago: The University of Chicago Press.
- Postal, Paul. 1971. *Crossover Phenomena*. New York: Holt, Rinehart and Winston.
- Rebuschi, Georges. 1999. "Types de langues et types de constructions: le cas des correlatives". *LINX*, numéro spécial thématique *Typologie des langues, universaux linguistiques*, 55-72.
- Rebuschi, Georges. 2009. "Position du basque dans la typologie des relatives corrélatives". *Langages* 174.25-38.
- Shukla, Shaligram. 1981. *Bhojpuri Grammar*. Washington, D.C.: Georgetown University Press
- Singh, Udaya Narayana. 1980. "Relative Clause Formation in Maithili". *Nepalese Linguistics* 1.27-39. (<http://www.ciil.org/Main/Faculty/uday.html>).
- Srivastav, Veneeta (Dayal). 1988. "Relative Clauses in Hindi and Learnability". In V. Srivastav, J.W. Gair, and K. Wali (eds.), *Papers on South Asian Linguistics*. Special Issue of *Cornell University Working Papers in Linguistics* 8.133-160.
- Srivastav, Veneeta (Dayal). 1991. "The syntax and semantics of correlatives". *Natural Language and Linguistic Theory* 9.637-686.
- Thompson, Sandra A., Park, Joseph Sung-Yul, and Charles N. Li. 2006. *A Reference Grammar of Wappo*. Berkeley: University of California Press. (http://repositories.cdlib.org/ucpress/ucpl/vol_138/).
- Tiffou, Étienne and Richard Patry. 1995. "La relative en bourouchaski du Yasin". *Bulletin de la Société de Linguistique de Paris*, 90.335-91.
- Uriagereka, Juan. 1995. "Aspects of the Syntax of Clitic Placement in Western Romance". *Linguistic Inquiry* 26.79-123.

- Vries, Mark de. 2002. *The Syntax of Relativization*. Ph.D. Dissertation, University of Amsterdam.
- Wali, Kashi. 1982. "Marathi Correlatives: A Conspectus". In P. J. Mistry (ed.), *South Asian Review: Studies in South Asian Languages and Linguistics*. Jacksonville, Florida, South Asian Literary Association. 78-88. (reprinted in K. Wali. 2006, pp. 288-297).
- Wali, Kashi. 2006. *Marathi*. Delhi: Indian Institute of Language Studies.
- Zribi-Hertz, Anne and Jean-François Hanne. 1995. "Pronoms, determinants et relatives en bambara de Bamako". *Linguistique africaine* 15.91-136.

Remarks on PRO_{arb}

Francesco Costantini and Vesselina Laskova

University of Venice

1. Introduction

While in the past thirty years we have learned a lot about the syntax and semantics of controlled PRO, little progress has been made in our understanding of the syntax and semantics of PRO_{arb}. Syntactically, it is still unclear whether PRO_{arb} is “free”, that is, uncontrolled, as the seminal studies on Control (Williams 1980 and Chomsky 1981) suggested, or whether it is controlled, as a series of subsequent studies claimed. Semantically, we do not know exactly what its semantic contribution is: is it “generic” (Williams 1980 and others), or generic *and* first-personal (Moltmann 2006)? And if it is generic, why does it show up as specific in certain contexts? Last but not least, we do not even know whether PRO_{arb} really exists: Chierchia (1988) argues against the existence of PRO_{arb} on semantic grounds, Hornstein (1999) identifies it with small *pro* mainly on syntactic grounds.

This paper is an attempt to give a sense of these issues. We will be mainly concerned with the questions related to Control and the semantics of PRO_{arb}, assuming that there exists a syntactic formative corresponding to PRO_{arb}. In reviewing the main ideas on PRO_{arb} we will first face a purely empirical question: In which syntactic environments does PRO_{arb} occur? Even in this respect PRO_{arb} raises problems, since what sometimes has been labeled “PRO_{arb}” is in fact – as we take – an instance of implicitly controlled PRO, whose meaning recalls the “arbitrary” interpretation. Adjunct Control is a case in point. Although the similarities between Adjunct Control and “Arbitrary Control” (as following Landau 2000, we will call the “cases where no argument in the sentence, either overt or implicit, is understood as the controller”) may not be accidental, we will

University of Venice

Working Papers in Linguistics

Vol. 19, 2009

leave these cases out of the scope of this article and focus on the prototypical occurrences of PRO_{arb} , namely subject clauses.

This paper is organized as follows. After considering the distributional properties of PRO_{arb} , we will discuss some ideas concerning the syntax and the semantics of PRO_{arb} . As for the syntax of PRO_{arb} we will show that even the cases where a general consensus holds about PRO_{arb} as thematically controlled, are not so doubtless. We will then analyze the semantic properties that have been singled out in the literature on PRO_{arb} and show that even in this respect some facts may have been misinterpreted. We will then discuss some issues concerning a class of predicates that rules out infinitive arguments (and PRO_{arb}) – namely, epistemic modals. Finally we will present some remarks on the *de se* reading that PRO_{arb} apparently displays.

2. Empirical framework

PRO_{arb} has been claimed to occur in a wide range of environments:

A. Infinitival clausal argument of different categories of adjective: “psychological” (examples (1)a), “evaluative” (examples (1)b and c), *deontic* modal adjectives (examples (1)d and e):

- | | | | |
|-----|----|--|---------------------------|
| (1) | a. | It is fun [PRO_{arb} to play baseball] | (Epstein 1984) |
| | b. | It is important [PRO_{arb} to get an A in math] | (Chomsky 1981) |
| | c. | [PRO_{arb} to walk alone at night] is dangerous | (Bhatt and Izvorski 1998) |
| | d. | It is necessary [PRO_{arb} to go] | (Roepers 1987) |
| | e. | [PRO_{arb} to take the exam] is obligatory | (Moltmann 2006) |

B. Infinitival clausal argument of “causative” verbs:

- | | | | |
|-----|----|--|----------------|
| (2) | a. | [$PRO_{arb/1}$ to behave oneself/himself in public] would help Bill ₁ | (Manzini 1983) |
| | b. | [$PRO_{arb/1}$ to behave oneself/himself in public] would help Bill ₁ 's development | (Manzini 1983) |

C. Infinitival indirect questions (‘wh-complements’):

- | | | | |
|-----|----|---|----------------|
| (3) | a. | It is unclear [how PRO_{arb} to behave oneself] | (Chomsky 1981) |
|-----|----|---|----------------|

- b. John asked [how PRO_{arb} to behave oneself] (Manzini (1983))

D. Copulative structures:

- (4) [PRO_{arb} making a large profit] requires [PRO_{arb} exploiting the tenants]
(Epstein 1984)

E. Adjunct clauses (rationale, temporal, absolutive or *without*-clauses):

- (5) a. Boats are sunk [PRO_{arb} to collect the insurance] (Bhatt and Pancheva 1998)
 b. [Before PRO_{arb} entering the basement], the stairs were washed (Manzini 1986)
 c. The game was played [PRO_{arb} wearing no shoes] (Roeper 1987)
 d. The president was elected [without PRO_{arb} considering his competence]
 (Roeper 1987)

In the environments (A) and (B), other constituents within the infinitival clause may enforce the arbitrary interpretation of PRO:

- (6) a. It is dangerous for babies_i [PRO_{arb} to smoke around them_i] (Kawasaki 1993)
 b. It helped John_i [PRO_{arb} to teach him_i Spanish] (Kawasaki 1993)

Finally, the presence of PRO_{arb} is banned in Obligatory Control infinitives PRO_{arb}:

- (7) a. *John wanted [PRO_{arb} to be quiet] (Landau 2000)
 b. *John remembered [PRO_{arb} not to smoke around the babies] Landau (2000)

Whether all or just some environments involve PRO_{arb} is a debated question. While the environments in (A), (B), (D) and (E) have been claimed to involve PRO_{arb}, *wh*-infinitives are probably instances of Partial Control (Landau 2000). It is nonetheless debatable whether the environment in (A), (B), (D) and (E) all involve Arbitrary Control as defined by Landau (2000). We will address the question in the following section.

3. The Syntax of PRO_{arb}

Although in a series of seminal works on Control (Williams 1980, Chomsky 1981, Manzini 1983) PRO_{arb} was claimed to be “free”, that is, uncontrolled, later works privileged the opposite solution. Examples (1) and (5) have been taken as evidence that Arbitrary Control is in fact Control by an implicit argument (Epstein 1985, Bhatt and Izvorski 1998), which may be assigned different theta-role: the experiencer role (examples (1)a, b), the benefactive (examples (1)c-e), or the agent (examples (5)).

This idea also predicted that monadic predicates cannot take an infinitival clause as their argument, since a controller for PRO would be missing and PRO would be uncontrolled. Since epistemic modals are monadic, the ungrammaticality of the following examples was interpreted as evidence in favor of the thematically controlled theory of PRO_{arb}:

- (8) a. *To play baseball is certain.
 b. *It is probable [PRO to go]

In other environments, however, it is unclear whether PRO_{arb} is controlled or not. A general agreement is missing whether an implicit argument occurs in examples (3) and (4). Bhatt and Izvorski (1998) classify the examples in (3) as an instance of implicit Control, Landau 2000 as Partial Control. Bhatt and Izvorski (1998) consider example (4) as involving Implicit Control, too, but Lebeaux (1984), Cinque (1988), Landau (2000), Moltmann (2006) label such example as a case of Arbitrary Control. Finally, as far as we know, the examples in (2) and (6) have never been claimed to involve Implicit Control. Manzini (1983) and Landau (2000) interpret them as real instances of Arbitrary Control.

Finally, a general consensus is also missing on the mechanisms of Control involved in the above examples. Epstein (1985) and Bhatt and Izvorski (1998) claim that PRO_{arb} is controlled by an implicit argument, Lebeaux (1984) and Kawasaki (1993) have hypothesized that A'-positions may be involved in the Control relation. We will briefly review these viewpoints.

3.1. Control Theories of PRO_{arb}

Building on examples like (1)a, the intuitive interpretation of which is that playing baseball is fun *for whoever plays baseball*, Epstein (1984) proposes that PRO_{arb} is controlled by an implicit argument, which may be made overt by a *for*-clause:

(9) It is fun for Lucy to play baseball.

Epstein suggests the possibility that in general PRO *must* be controlled by an implicit argument. This idea, he argues, would explain the difference in status between sentences like (1)a and sentences involving epistemic modals (see (8)), which disallow *for*-clauses. The availability of a *for*-clause is the only diagnostics to show that a covert argument occurs. This diagnostics builds on the observation that if in a given structure an argument satisfying a theta-role *can* occur, then it must occur, since the theta-grid of a predicate is invariable. Thus, if there is no overt argument in that structure, that argument must be covert.

Lebeaux (1984) claims that PRO_{arb} is controlled as well. Differently from Epstein, however, he claims that Control on PRO_{arb} is not thematic. Rather, an adjunct within the binding domain of PRO_{arb} controls it. Thus, while Epstein claims that PRO_{arb} is controlled from an A-position, Lebeaux claims that it is controlled by an A'-position. This allows him to explain data that do not include any implicit controller, like the examples involving an indirect question (see example (10)a below), the so-called “linked reading” structures (copulative structures, see example (4)), and the examples where PRO_{arb} does not seem to co-vary with an implicit argument, as in the following example:

(10) a. John knows [how PRO_{arb} to solve the problem].
 b. [What PRO_{arb} to do] is unclear.

In the sentence in (10)a the main predicate does not have any implicit argument Controlling PRO, since the argument structure of *know* has two positions and PRO may not be interpreted as controlled by *John*. In (10)b PRO does not necessarily co-vary with the implicit argument of *unclear*.

Bhatt and Izvorski (1998) improve Epstein’s theory of PRO_{arb} in that they claim that Arbitrary PRO is always controlled by an implicit argument *à la* Williams (1985) in the immediately higher clause. They extend their proposal to generic passives and propose a solution for the data that apparently could not be reduced to Epstein’s thematically con-

trolled PRO_{arb} theory – namely, the *wh*-complement infinitives, and to the so-called ‘linked readings’.

In their view, all these environments do include an implicit argument controlling PRO. As for the passives and the ‘linked reading’ structures, they apply the *for*-clause diagnostic test as a piece of evidence in favor of their claim:

- (11) a. Ships are sunk [PRO_{arb} to collect insurance]
 b. Ships are sunk by their owners_{*i*} [PRO_i to collect insurance]
- (12) a. [PRO_i to know him] is [PRO_i to love him]
 b. For Pat_{*i*}, [PRO_i to know him] is [PRO_i to love him]

As for PRO_{arb} occurring in *wh*-complement infinitives, they observe that *wh*-complements are implicitly modals. Particularly, the modality involved is deontic. A sentence like (10)a can be paraphrased as follows: “John knows how one should/could solve the problem”. Similar consideration may explain the intuitions about the sentence in (10)b. Thus, they claim that the argument of the implicit deontic modal controls PRO.

3.2. Analytical remarks

Despite Bhatt and Izvorski’s theory is able to explain a larger set of data than previous theories, some problems remain unsolved:

- a.** Under the hypothesis that an implicit argument appears in every environment where PRO_{arb} occurs, it must be postulated that an implicit argument occurs in the sentences in (2) and (6). However, every theta-role appears to be assigned in these sentences.
- b.** In examples involving the ‘linked readings’, the question arises, what theta-role do predicates like *be*, *mean*, *entail*, *require* assign to the argument that can be made overt through a *for*-clause? The question is not faced directly in Bhatt and Izvorski (1998). They only point out that such a role is not an evidential role (in the sense of Schweikert 2005), since it cannot be paraphrased as *in x’s opinion*.¹ Moreover, such a theory should explain why an implicit controller occurs in the examples in (2), in (4), and in (6), but it

¹. Bhatt and Izvorski (1998), n. 17.

does not in (8). However, if there is no implicit argument in (8), why should there be one in the other examples?

c. There is no general agreement on the presence and on the role of implicit arguments in some of the examples where an implicit argument is postulated. We focus on the case of deontic modals.² Bhatt (1999) and Wurmbrand (1999) argue that the bearer of the obligation or of the permission (which in (1)d,e is assumed to be implicit in thematically controlled PRO_{arb} theories) is not syntactically represented in some contexts. Consider the following example:

(13) There must be fifty chairs in this room by 5 p.m. (said to a caterer)

(Bhatt and Izvorski 2006)

². As for Control in adjunct clauses the presence of a implicit controller is also doubtful. Let us consider first rationale clauses. Examples that have been claimed as involving an implicit agent may have been misinterpreted, since in many cases PRO_{arb} does not seem to need a controller, or a potential controller cannot Control PRO_{arb}:

- (i) a. The shopwindow has a big sale sign in it [(in order) PRO_{arb} to attract customers] (Farkas 1988)
 b. *The ship was sunk [PRO_{arb} to become a hero] (Lasnik 1988)

As for temporal clauses, absolutive clauses, and clauses introduced by *without*, the idea that the implicit agent obligatorily Controls PRO_{arb} has often been argued (Borer 1989, Clark 1990, Hornstein 1999). However, the implicit agent seems to have some restriction belonging exclusively to these structures, as the [+human] feature observed by Manzini (1986). Kawasaki (1993) claims that the [+human] restriction reflects the fact that adjunct Control is not agent Control but rather ‘topic Control’, i.e. the reference of PRO is determined by the current discourse topic, which is established pragmatically. Kawasaki proves this claim observing that definite NPs, but not indefinite NPs, can Control PRO_{arb} in an adjunct:

- (ii) After collecting some money, a bank account was opened by the/*a businessman.

Definite NPs refer to an entity already present in the discourse, while indefinite NPs introduce new entities. Thus, only definite NPs can work as discourse topic. Moreover, subjects work as topic easier than objects. Thus, PRO_{arb} can be controlled by subjects better than by objects:

- (iii) a. John harassed many women. ??After talking to the manager, complaints were filed.
 b. Many women were harassed by John. After talking to the manager, complaints were filed.

Finally, if the discourse topic is salient enough, it can Control PRO_{arb} without even being represented grammatically:

- (iv) After pitching the tents, darkness fell quickly.

Here the “obligee” is not represented syntactically –at least, not as an argument of the matrix predicate. Thus, at least in some cases, the obligee or the permittee of a deontic modal do not have an obvious syntactic realization. Wurmbrand (1999) even suggests that the relation of obligation and permission involved in deontic modality is not encoded through theta-roles, but rather through pragmatic roles. Note that such roles *can* Control PRO_{arb} in a rationale clause:

(14) There must be some time [PRO_{arb} to organise supply and demand].

PRO_{arb} is here licensed despite no implicit argument, is present.

The question then arises, what licenses PRO_{arb} . Whatever licenses it, must occur in the sentences where PRO_{arb} appears, but it must be absent in sentences where PRO_{arb} is ruled out –as in (8)– unless the ungrammaticality of (8) is due to completely different reason than the presumed illegitimacy of Control on PRO_{arb} .

All in all, the claim that PRO_{arb} is thematically controlled by an implicit argument does not appear to be supported by strong evidence. While examples involving an implicit experiencers, like (1)a and b, appear to be compatible with the theory of Control by an implicit argument quite naturally (although the only evidence argued in favor of this view is the optionality of a *for*-clause), the other examples are hardly explicable through such theory.³ In examples involving “evaluative” and modal predicates (sentences (1)b, c, d, e), an implicit argument may not be there, and if there is one, the co-variance of the implicit argument and PRO is not obligatory (see example (6)a). The question is then,

³. It didn't escape our notice that structural considerations may explain why only implicit experiencers are the only implicit arguments that PRO_{arb} obligatorily co-varies with. An argument satisfying the experiencer theta-role is merged above an arguments satisfying the causer theta-role (Belletti and Rizzi 1988, Pesetsky 1995, Schweikert 2005). Infinitives are assigned the latter role. Thus, experiencers c-commands PRO :

(i) [Exp... [PRO_{arb} ...]]

Causer arguments, in their turn, c-command the theme, the benefactive, and the patient – thus, infinitives c-command implicit benefactives/patient, but PRO_{arb} does not:

(ii) [[PRO_{arb} ...] Th/Ben/Pat...]

Whether these structural properties determine the co-variance of PRO_{arb} and the argument of the main verb is a challenging question.

when thematic Control does not hold, how does PRO_{arb} get its interpretation? Is it uncontrolled or is it A'-controlled?

In the examples in (2) PRO_{arb} does not seem to be thematically controlled as well, since all theta-roles of the matrix predicate appear to be discharged. Here, again, PRO_{arb} may be “free” or A'-controlled. In examples (3)-(5), finally, there is no compelling evidence in favor of a thematic Control analysis. The only proof in favor of such proposal has been claimed to be the availability of an overt argument in place of the implicit argument which PRO_{arb} appears to co-vary with. However, PRO_{arb} may not co-vary with such overt argument. Thus, on one hand, Control by an implicit argument is not to be taken for granted – an overt argument may not control obligatorily PRO_{arb}, so why should an implicit argument? On the other hand, PRO_{arb} appears not to need a thematic controller at all. Some considerations from the domain of semantics point to the same conclusion.

4. The Semantics of PRO_{arb}

Despite the different claims on the syntactic mechanisms concerning PRO_{arb}, a substantial uniformity characterizes PRO_{arb} from a semantic viewpoint: in all environments illustrated in section 2 the interpretation of PRO is “generic” (more properly, kind-referring), if the sentence is generic, specific (more properly, object referring), if the sentence is episodic, no matter if there is an implicit controller (see Cinque 1988,⁴ Kawasaki 1993, Bhatt and Izvorski 1998).⁵ Let us illustrate this point through a couple of examples discussed in Krifka *et al.* (1995):

⁴. Cinque (1988) claims in fact that PRO_{arb} is interpreted as a ‘quasi-universal quantifier’. As far as we understand, the term ‘quasi-universal’ is equivalent to the term ‘generic’.

⁵. Cinque (1988) observes that in its ‘quasi-existential’ reading, the reference of PRO_{arb} can be specified by the context or it may correspond to a 1st person plural pronoun ‘we’. He also notes that ergative, psych-, movement, copulative, passive, and raising predicates can only induce a 1st person plural interpretation, although a different interpretation cannot be excluded contextually:

(i) Partire in ritardo (*mi pare fosse stato Carlo) ha significato perdere tutto.

‘To leave late (I think it was Carlo) meant to lose everything.’

Analyzing this problem, however, would lead us too far away from the aims of the present paper.

- (15) a. [PRO_{arb} chewing tobacco] (usually) upsets John.
 b. [PRO_{arb} chewing tobacco] upset John.

Sentence (15)a can be generally paraphrased as ‘if one chews tobacco, this generally upsets John’. Sentence (15)b can instead be paraphrased as ‘someone chewed tobacco and this upset John’. This double interpretation holds even in environments where PRO_{arb} has sometimes been claimed to be controlled (examples from Bhatt and Izvorski (1998):

- (16) a. [PRO_{arb} to write haiku] is fun.
 b. Yesterday, [PRO to write haiku on the grass] was fun.

Sentence (16)a is generic, sentence (16)b is episodic.⁶ Thus, even if we admitted that an implicit argument controlled PRO_{arb}, the semantics of this argument would display no difference with respect to uncontrolled PRO_{arb}.⁷ The question is then, how is the index ‘arb’ to be interpreted?

Moreover, PRO_{arb} has been claimed to be first-personal (in the sense of Castañeda 1966, 1967) and, at the same time, generic. To illustrate:

- (17) a. It is nice [PRO_{arb} to walk in the park].

⁶. Other semantic properties have been sometimes discussed in the literature. First, Manzini (1986) claims that PRO_{arb} can only refer to human beings. To illustrate, consider the following sentences:

- (i) a. [PRO_{arb} rotolare giù da una collina] è pericoloso.
 [PRO_{arb} to roll down the hill] is dangerous.
 b. [PRO_{arb} essere efficienti] è importante.
 [PRO_{arb} to be effective] is important.

The only possible interpretation of the sentences in (i) is that PRO_{arb} has [+human] features. We will keep these property of PRO_{arb} outside the scope of the present investigation.

⁷. Epstein (1984), Lebeaux (1984), and Bhatt and Izvorski (1998) labels by ‘PRO_{arb}’ only the occurrences of PRO with a generic interpretation, assuming that under the existential reading the reference of PRO is not ‘arbitrary’, but rather pragmatically specified by the discourse context. In what follows, we will use of the term ‘arbitrary PRO’ to refer to PRO in contexts as those illustrated in section 2, and specify within the discussion whether its interpretation is generic or specific.

- b. Yesterday it was nice [PRO_{arb} to walk in the park].
 c. John said it is nice [PRO_{arb} to walk in the park].

Moltmann observes that intuitively such sentences express an evaluation on the part of the speaker. In uttering (17)a and b, there is a natural reading in which the speaker is expressing a personal judgment about the kind of events “walking in the park” ((17)a) and as a specific occurrence of such kind of event ((17)b). More generally, such sentences convey an evaluation on the part of the agent of the context (the speaker in sentences (17)a, b, the subject of an attitude predicate, as in (17)c, which does not presupposes that the speaker find it nice to walk in the park), based on her/his own (actual or imaginary) experience. At the same time, Moltmann claims that the former sentence expresses a generalization concerning any typical person.

As far as we know, the only formal attempt to account for these properties has been worked out by Moltmann (2006), who claims that like the English impersonal pronoun *one*, PRO_{arb} introduces a variable that is obligatorily bound by a sentential generic empty operator (hosted in [spec; CP]).⁸ In Moltmann’s view, the fact that different occurrences of *one*/PRO_{arb} may co-vary without either having scope over the other is a piece of evidence in favor of her analysis. The examples in (4), here repeated, may be taken as illustrating this property:

(18) [PRO_{arb} making a large profit] requires [PRO_{arb} exploiting the tenants].

Here the two PRO_{arb}’s corefer. However, the PRO_{arb} in the higher clause does not c-command the one in the lower clause. Thus, the covariance of the higher and of the lower PRO_{arb} cannot result from a binding relation of the higher on the lower PRO_{arb}. Assuming that co-reference is obtained here as a scope phenomenon,⁹ the co-variance of the two PRO_{arb}’s may only be the result of the presence of an operator c-commanding and binding both PRO_{arb}’s.

We note, however, that *one* and PRO_{arb} do differ in at least one respect: PRO_{arb} can have a specific reading, while *one* cannot. This may be accommodated within Moltmann’s proposal by claiming that in episodic sentences the existential sentential operator bind-

⁸. I refer to Moltmann (2006) for the formal details of his theory.

⁹. This is in fact an assumption only, since binding is not the only way to get covariance (see Safir 2005).

ing the event variable of the main predicate, binds PRO_{arb} as well (although for some reason it cannot bind the impersonal pronoun *one*). Such an assumption is costless, since in a davidsonian framework (Davidson 1967, Higginbotham 1983, Parsons 1990), an existential operator does bind the event argument of a predicate.

Note that Moltmann's theory has two theoretical implications. First, PRO_{arb} is *always* controlled, though (second implication) it is *not thematically controlled*, since a sentential operator binds it. In other terms, PRO_{arb} is claimed to be A'-controlled (as in Lebeaux's 1984 and Kawasaki's 1993 theories).

This may not be the last word, however. We know indeed that that kind-level predicates (as *common*, *rare*, *widespread*, etc.) apply felicitously to gerunds and to infinitives (Krifka *et al.* 1995):

- (19) a. Getting into troubles is very common/rare/widespread among the youth today.
(Carlson 1977)
- b. For people to love their children is common.

This diagnostics shows that gerunds and infinitives can be interpreted as referring to kinds – particularly, to kinds of events. This explains why even in contexts where the apparent controller of PRO_{arb} is explicit, the interpretation of a gerundive or of an infinitival is kind-referring. Consider for instance the following sentence (from Krifka *et al.*):

- (20) Chewing tobacco calms John down.

This sentence normally asserts that whenever John chews tobacco, this (usually) calms him down. The gerundive clearly refers to a kind of events, which has as realizations single events of chewing tobacco by John.

Thus, the generic operator binds the event variable of an infinitival (or gerund) clause, rather than PRO_{arb} . This is shown even by another diagnostics of genericity (Krifka *et al.* 1995). In generic sentences a frequency adverb like *always*, *generally*, *habitually* does not convey a “significant” change in meaning. Consider for instance the following sentences:

- (21) a. Dogs bark.
b. Dogs generally bark.

In the latter sentence the semantic contribution of the adverb is minimal – it only underlines that there may be exceptions. When this diagnostics is applied to PRO_{arb} a relevant change in meaning is determined:

- (22) a. [Playing baseball] is fun.
 b. [Playing baseball habitually] is fun.

The two sentences have different truth-conditions. While the first one may assert that an event of playing baseball is generally fun, the second asserts that the *habit* of baseball-playing is fun. Thus, one may consider the first sentence as false while considering the second one true and vice versa.

We take then that PRO_{arb} does not have a “generic” or “specific” interpretation in itself. This rather appears as a by-product of some other computation. But how is it interpreted? A possible answer to this question may be as follows. Since the kind-referring interpretation holds when a nominal is under the scope of a generic operator, gerunds and the infinitives, rather than PRO_{arb} itself, appear to be subjected to the generic operator. Under this view, the semantics of PRO_{arb} should be redefined. Two options are available: first, PRO_{arb} is interpreted by existential closure; second, it is interpreted as a lambda-operator, as in predicational approaches to Control (Lewis 1979, Chierchia 1984, among the others). In both cases, the “generic”/“specific” interpretation of PRO_{arb} may turn out as a by-product of the binding of the whole non-finite clause. We suppose there is good reason to prefer the second option. The evidence is the fact that the scope ambiguities one would expect if PRO_{arb} were bound by an existential operator are missing.¹⁰ Consider the following sentences:

¹⁰. We note that although implicit arguments are usually considered as an existential operator, they do not give rise to scope ambiguities, as quantifiers generally do. Consider the following sentences containing an implicit agent:

- (i) Every ship has been sunk.
 (ii) Every ship has been sunk by an angry dismissed insurance company employee.

Sentence (ii) is ambiguous between the *de dicto* ($\forall > \exists$) and the *de re* interpretation ($\exists > \forall$): under the first interpretation for any ship there is an angry dismissed employee, under the second interpretation, one and the same angry dismissed employee sank every ship ($\forall > \exists$). No such ambiguity appears to hold with respect to (i), in which the universal quantifier has always wide scope. Thus, the nature of the implicit agent remains quite mysterious.

- (23) a. Every student said that answering his questions was of great help to him.
 b. Every student said that it was of great help to him that a teacher answered his questions.

Intuitively, sentence (23)b has two readings:

- (23) b'. $\forall x \exists y$ x said that answer (y, x's questions, e) & e helped x
 b''. $\exists y \forall x$ x said that answer (y, x's questions, e) & e helped x

Under the first reading, for every student there is a teacher who answered his questions. Under the second reading, one and the same teacher answered every student's questions.

Sentence (23)a does not display such scope ambiguities. The only available interpretation is the one in which the universal quantifiers takes scope over the existential operator:

- (23) a'. $\forall y \exists x$ x said that answer (y, x's questions, e) & e helped x
 a''. $*\exists y \forall x$ x said that answer (y, x's questions, e) & e helped x

Observing that a second sentential operator can also appear within a non-finite argument (see Zucchi 1990, Krifka *et al.* 1995),¹¹ we propose that, in a davidsonian framework, an appropriate logical form for sentences containing PRO_{arb} may be as follows:

- (24) a. '**Generic**' PRO_{arb}
 $GENe P(e, \wedge GEN/\exists e'\lambda x Q(e', x));$
 b. '**Specific**' PRO_{arb}
 $\exists e P(e, \wedge GEN/\exists e'\lambda x Q(e', x));$

To any of the above formulas an argument may be added to the main predicate. We propose that when such an argument is implicit, it is in its turn interpreted as a lambda-

¹¹. To illustrate, consider the following sentence (adapted from Krifka *et al.* 1995):

- (i) [Smoking so much habitually] (generally) impresses Mary.

The infinitive predicate is generic (more properly habitual), the main predicate can be either generic or specific.

operator. This would explain why Control apparently holds between an implicit argument and PRO_{arb} . Our proposal predicts that they should get co-valued. If the argument is overt, PRO_{arb} *can* be interpreted as bound by such an argument, perhaps through the topic-Control mechanism proposed by Kawasaki (1993).

5. Epistemic modals

Thematically controlled PRO_{arb} supporters have often claimed that the ungrammaticality of sentences like (8) has to be interpreted as evidence in favor of their theory, since, as PRO_{arb} must be controlled, the absence of a controller in these sentences dooms its occurrence.

Under the account we are discussing here, PRO_{arb} is not thematically controlled (it may even not be controlled at all). If so, the unavailability of infinitival complements in epistemic modal contexts cannot be due to the absence of a potential controller. So why are sentences like (8) ungrammatical?

First, observe that the lack of an implicit controller does not rule out PRO_{arb} in itself, since, as we have shown, there are sentences in which PRO_{arb} occurs despite an implicit argument is missing. Second, if the interpretation of PRO_{arb} indirectly depends on sentential operators, the theory here investigated predicts that structures that are devoid of such operators cannot host an infinitive or a gerund argument. Under such a hypothesis, epistemic modal sentences should be devoid of sentential operators.

As it turns out, this seems to be the case. Iatridou (1990) observes that epistemic modal predicates (“metaphysical modality” predicates, as she dubs them) are incompatible with past or future tense auxiliaries:

(25) #It was/will be probable that John stole the tape.

She claims that epistemic modals are temporally independent, that is, they lack a time variable, which explains why they are incompatible with tense.

We may add that genericity diagnostics (Krifka *et al.* 1995) shows that epistemic modals are incompatible with generic operators as well:

(26) #It is usually possible that John has left.

Sentential operators are incompatible with epistemic modals exactly because epistemic modals lack a time variable. Thus, since infinitival clauses have a time variable that must be bound by a sentential operator, the ungrammaticality of (8) may be reinterpreted as a superficial effect of the lack of this operator in sentences having an epistemic modal predicate.

6. Conclusive remarks

In the present article we have reviewed the main ideas on the syntactic and semantic properties of PRO_{arb} and we hope we have shown that a great deal is still to be achieved in our understanding of PRO_{arb} . We have shown that the presence of an implicit argument, if any, does not seem to be related to Control of PRO_{arb} , and that there is no compelling evidence to claim that PRO_{arb} is thematically controlled, since there are cases where no implicit argument can plausibly be claimed to occur. The remaining possible alternatives are that in some cases it appears to be A'-control (Kawasaki's 1993 Topic Control), or that a lambda-variable, it is uncontrolled. On the semantic side, its "generic" or "specific" interpretation appears to raise as a by-product of mechanisms responsible for the interpretation of an infinitive and of the whole sentence.

We would like to conclude this paper with a final speculation concerning the first-personal interpretation. We have said that Moltmann (2006) observes that sentences in which PRO_{arb} occurs have a natural reading in which the agent of the context is expressing a personal evaluation. In subsequent work (2008 among others), she observes that sentences containing a subject infinitive are relative-truth sentences, a kind of sentences whose truth-conditions are relative to a standard of taste, morality or knowledge of the individual who utters the sentence or to whom an evaluation towards a certain propositional content is attributed. All seems to suggest that the "evaluator", which we take as a pragmatic role, plays a crucial role in the interpretation of sentences containing PRO_{arb} and perhaps of PRO_{arb} itself, and may be the source of the first personal interpretation. The way the evaluator enters the computation of semantics of the sentence is still to be made clear, but a direct Control by the evaluator on PRO_{arb} seems to have little plausibility in our view, since PRO_{arb} is not simply interpreted as the speaker (in the easiest case). In uttering *It is nice to walk in the park*, the speaker is not asserting that she or he is the only person who finds it nice *his* walking in the park. This is the interpretation we would expect were the evaluator Controlling PRO_{arb} , but, crucially, this does not reflect

our intuitions, since in saying this sentence, we are also stating something that in our view seems to hold for any typical person.

References

- Bhatt, Rajesh. 1999. *Covert Modality in Non-Finite Contexts*. PhD diss. UPenn, Philadelphia.
- Bhatt, Rajesh and Roumyana Izvorski. 1998. "Genericity, Implicit Arguments and Control", *Proceedings of SCIL 7, MITWPL*.
- Bhatt, Rajesh and Roumyana Pancheva. 2006. "Implicit Arguments". In M. Everaert and H. van Riemsdijk (eds.), *The Blackwell Companion to Syntax. Volume II*, 558-588. London: Blackwell.
- Borer, Hagit. 1998. "Deriving Passives Without Theta Roles". In S. LaPointe, D. Brentari, P. Farrell (eds.), *Morphology and its Relation with Phonology and Syntax*, 60-110. Stanford: CSLI Publications.
- Carlson, Gregory. 1977. *Reference to Kinds in English*. PhD diss. UMass, Amherst.
- Castañeda Hector-Neri. 1968. "On the Logic of Attributions of Self-Knowledge to Others". *The Journal of Philosophy*, 65/15: 439-456.
- Castañeda, Hector-Neri. 1966. "He*: a Study in the Logic of Self-Consciousness". *Ratio* 8: 130-157.
- Chierchia, Gennaro. 1984. *Topics in the Syntax and Semantics of Infinitives and Gerunds*. PhD diss. UMass, Amherst.
- Chomsky, Noam. 1981. *Lectures on Government and Binding*. Dordrecht: Foris.
- Cinque, Guglielmo. 1988. "On *Si* Constructions and the Theory of *Arb*". *Linguistic Inquiry* 19, 521-581.
- Clark, R. 1990. *Thematic Theory in Syntax and Interpretation*. London and New York: Routledge.

- Davidson, Donald. 1967. "The logical form of action sentences". In N. Rescher (ed.), *The Logic of Decision and Action*, 81-95. Pittsburgh: Pittsburgh University Press.
- Epstein, Samuel. 1984. "Quantifier-*pro* and the LF representation of *PRO*_{arb}". *Linguistic Inquiry* 15, 499-505.
- Farkas, Donka. 1988. "On Obligatory Control". *Linguistics and Philosophy* 11: 27-58.
- Higginbotham, James. 1983. "The logic of perceptual reports: an extensional alternative to Situation Semantics". *Journal of Philosophy* 80: 100-127.
- Hornstein, Norbert. 1999. "Movement and Control". *Linguistic Inquiry* 30, 69-96.
- Iatridou, Sabine 1990. "The Past, the Possible, and the Evident". *Linguistic Inquiry* 21: 123-129.
- Jackendoff, Ray. 1972. *Semantic Interpretation in Generative Grammar*. Cambridge: MIT Press.
- Kawasaki, Noriko. 1993. "Control and Arbitrary Interpretation in English". PhD diss., UMass, Amherst.
- Kratzer, Angelika. 1991. "Modality". In A. von Stechow, D. Wunderlich (eds.), *Semantics: An International Handbook of Contemporary Research*. Berlin: de Gruyter.
- Krifka, Manfred, *et al.* 1995. "Genericity: an Introduction". In G. N. Carlson and F. J. Pelletier (eds.), *The Generic Book*, 1-124. Chicago and London: The University of Chicago Press.
- Landau, Idan. 2000. *Elements of Control*. Dordrecht: Foris.
- Lasnik, Howard. 1988. "Subjects and θ -Criterion". *Natural Language and Linguistic Theory* 6, 1-17.
- Lebeaux, D. 1984. "Anaphoric Binding and the Definition of PRO". *NELS* 14, 253-274.
- Lewis, David. 1979. "Attitudes *De Dicto* and *De Se*". *The Philosophical Review* 88, 513-543.
- Manzini, Maria Rita. 1983. "On Control and Control Theory". *Linguistic Inquiry* 14, 421-446.
- Manzini, Maria Rita. 1986. "On Control and Binding Theory". In S. Berman, J.-W. Choe and J. McDonough (eds.), *Proceedings of the North Eastern Linguistic Society* 16, 322-337. Amherst (MA): GLSA.
- Moltmann, Friederike. 2006. "Generic *one*, Arbitrary PRO, and the First Person". *Natural Language Semantics* 14, 257-281.
- Moltmann, Friederike. 2008. "Relative Truth and the First Person". Ms., IHPST/CNRS/ENS, Paris.
- Parsons, Terence. 1990. *Events in the semantics of English. A study in subatomic semantics*. Cambridge, MA: MIT Press.

- Perlmutter, David. 1971. *Deep and Surface Structure Constraints in Syntax*. New York: Holt, Rinehart and Winston.
- Roeper, Thomas. 1987. Implicit Arguments and the Head-Complement Relation. *Linguistic Inquiry* 18, 267-310.
- Ross, John Robert, 1969. Auxiliaries as main verbs. In W. Todd (ed.), *Studies in Philosophical Linguistics, Series 1*. Evanston.
- Safir, Ken. 2005. Person, Context and Perspective. *Rivista di Linguistica – Italian Journal of Linguistics*.
- Schweikert, Walter. 2005. *The Order of Prepositional Phrases in the Structure of the Clause*. Amsterdam: Benjamins.
- Williams, Edwin. 1980. Predication. *Linguistic Inquiry* 11: 203-238.
- Williams, Edwin. 1987. Implicit Arguments, the Binding Theory, and Control. *Natural Language & Linguistic Theory* 5, 151-180.
- Zucchi, Alessandro. 1989. *The Language of Propositions and Events. Issues in the Syntax and Semantics of Nominalization*. PhD diss. University of Massachusetts at Amherst.

Quantifiers as negative markers in Italian dialects

Jacopo Garzonio and Cecilia Poletto

University of Padua - University of Venice

1. Introduction

In her seminal work on negation in Italo-Romance, Zanuttini (1997) shows that negative morphemes in Italo-Romance varieties can be subdivided into four main classes according to the position they occupy in the clause structure. These positions, which she labels as Neg1, Neg2, etc. are represented in (1)

(1) [NegP 1 [TP 1 [NegP 2 [TP 2 [NegP 3 [Asp Perfective [NegP 4]...]

Neg1 is the position of preverbal negations like standard Italian *non*; Neg4 is the lowest negative morpheme. Neg2 and Neg3 are postverbal negations which are differentiated by the fact that the former (for instance Piedmontese *pa*) generally precede Tense Anterior adverbs like ‘already’, while the latter (for instance Piedmontese *nen*) appear inside the field of aspectual adverbs (Cinque 1999).

- (2) a. A l'è **pa** gia andait a ca'. (Piedmontese, Zanuttini 1997, 70)
SCL SCL is NEG already gone to home
'He has not already gone home.'
- b. *?A l'è **nen** gia andait a ca'.
SCL SCL is NEG already gone to home
'He has not already gone home.'

University of Venice

Working Papers in Linguistics

Vol. 19, 2009

- (3) a. *A l'è gia **pa** andait a ca'. (Piedmontese, Zanuttini 1997, 70)
 SCL SCL is already NEG gone to home
 'He has not already gone home.'
 b. A l'è gia **nen** andait a ca'.
 SCL SCL is already NEG gone to home
 'He has not already gone home.'

The position of NegP2 and NegP3 with respect to adverbs is different, moreover the two negative markers can cooccur and NegP2 always precedes NegP3:

- (4) I n mandj **pa nia** soni nkoe. (S. Leonardo Rhaeto-romance)
 I NEG eat NEG NEG potatoes today

In this work we concentrate on Neg2 and Neg3, which share an interesting property: both classes are made of elements derived from quantifiers originally merged in object position. These elements have been grammaticalized and in many cases their morphology is not identical to the corresponding quantifier in synchrony.

In this paper we observe that, even if both Neg2 and Neg3 were in origin object quantifiers, the two classes etymologically derive from two distinct types of quantifiers. Neg2 markers derive from grammaticalized minimizers (and we refer to them as 'm-negation'), which in origin appeared as the head noun of a complex DP structure followed by an obligatory PP complement. Neg3 markers derive from the bare negative inanimate quantifier corresponding to English 'nothing' (we refer to them as 'q-negation'). Thus, the different etymological and syntactic origin of the two quantifiers corresponds to a different syntactic position in synchrony when they are reanalyzed as negative markers, as Zanuttini has shown.

In this work we consider the diachronic development of m-negation and q-negation and provide evidence in favor of the hypothesis that, despite appearances, they do not follow the same grammaticalization path. We claim that the distinct syntactic position of the two types of negation in the modern dialects depends on the distinct evolution path they have taken, which in turn depends on their original properties.

At first sight, the diachronic development of these two types of postverbal negative markers is similar and obeys the usual stages of the well known Jespersen's cycle. The first stage is preverbal negation (we use examples from Piedmontese texts reported by Parry 1992; 1996 and p.c.):

- (5) a. Ni **non** poessa provarse che al fesa contra l'estatu. (Ordinamenti 138)¹
 neither NEG could prove that he did against the law
 'It could not be proved that he acted against the law.'
 b. E se **non** volesa confesarse. (Ordinamenti 172)
 and if NEG wanted to confess-REFL
 'And if he did not want to confess.'

In the second stage they both start out by cooccurring with the preverbal negative marker, as the following examples show.

- (6) E che l'error d'el main **ne** sia **nent** desmentia. (Comedia de l'homo)
 and that the mistake of the hands NEG be NEG forgotten
 'May hands' mistake not be forgotten.'
 (7) Una bona donzenha e **n**'basta **pa**. (Ballouria 48)
 a good dozen it NEG is-enough NEG
 'A good dozen is not enough.'

At this stage they are still optional (see Parry (1996) for Piedmontese), but later on they become obligatory (this is the stage in which Piedmontese was in the XVII century and the modern Rhaeto-romance varieties of S. Leonardo di Badia and Gardena are nowadays for q-negation and some Emilian dialects are for m-negation):

- (8) **An** tocca **nen** a mi. (El Cont Piolét 213)
 NEG touches not to me
 'It is not my turn.'
 (9) I **n** mandj **nia** soni nkoe. (S. Leonardo Rhaeto-romance)
 I NEG eat NEG potatoes today
 'I do not eat potatoes today.'

¹. The example is taken from the Piedmontese text *Ordinamenti dei Disciplinati e dei Raccomandati di Dronero*, quoted by Parry (1996), end of the XIV or beginning of the XV century.

In the final stage the postverbal negative marker is the only negative marker of the clause, which is the stage Piedmontese is in nowadays for q-negation and spoken French is for m-negation:

- (10) S'a fussa **nen** fasne la spiegasion. (Pipino 135)
 if it were NEG done the explanation
 'If it were not explained.'

Although both negative markers seem to follow the same general grammaticalization cline, we claim that at a closer inspection, the evolutionary paths of the two types of negative markers are not similar. Q-negation does not change its position from the beginning to the end of the process which transforms it into a negative marker. The reason for this is that the original object bare quantifier corresponding to 'nothing' in Old Italian already raises to a position dedicated to bare negative quantifiers in the functional domain of the clause, even when it is an object. When it is reinterpreted as an adverb, only the empty copy in object position is deleted, but the spell out position of the quantifier remains the same. On the contrary, m-negation changes from a DP internal position to an adverbial position located in the lower portion of IP, passing through a stage in which the original N indicating a small quantity and taking an object PP is reinterpreted as a functional item (a quantifier) of its original object DP. Only at this stage can the quantifier move into the functional domain of the clause to a position dedicated to existential quantifiers, which is not the same as the one occupied by q-negation. Therefore, the distinct position of the two negative markers originally observed by Zanuttini is a consequence of the value of the two original quantifiers which are then reanalyzed as negative markers.

The article is organized as follows: in section 2 we provide a backward description of the diachronic path that q-negation has undergone, starting from the modern varieties and then showing that at the intermediate stage when q-negation is used as a reinforcer, it is sensitive to the aspectual properties of the verb and that this is linked to its position in the aspectual IP field already proposed in Cinque (1999). Furthermore, we show that the original negative object quantifier can already raise higher than the past participle in Old Italian and has therefore not changed its position from the beginning to the end of the cycle.

In section 3 we analyze m-negation, which is originally a non negative object DP. It first has to be reanalyzed as a (non-negative) quantifier, which can then be moved to the

space dedicated to quantifiers in the low IP portion, but crucially not to the same position of the negative quantifier.

In section 4 we draw a comparison between the two diachronic processes and highlight some further perspectives for future research.

2. Q-negation

2.1. Q-negation in the modern dialects

The type of negative marker stemming from the bare quantifier ‘nothing’ has received little attention in the literature on Romance (apart from Zanuttini’s work), probably because it is only used in non standard Romance varieties, contrary to Germanic varieties, where the same type of negative marker has been widely investigated. In the Northern Italian domain, q-negation has developed into the standard negative marker in the dialectal areas of Piedmontese and some Rhaeto-romance dialects (while in other it still combines with the preverbal negative marker, see example (9)):

- (11) a. A parla **nen**. (Piedmontese - Turin)
 SCL speaks NEG
 ‘He/she does not speak.’
- b. Al ven **nia**. (Rhaeto-romance - Corvara²)
 he comes NEG
 ‘He does not come.’

Notice that the element is still homophonous with the negative quantifier meaning ‘nothing’ in Rhaeto-romance, while in Piedmontese, though etymologically related, the two words for the negative marker and the negative quantifier are nowadays different: *nen* is the negative marker, while *gnente* is the word for ‘nothing’.

Generally, this type of negative marker is either not compatible with negative quantifiers, as in Rhaeto-romance:

². Notice that this structure is only found for younger speakers, older speakers still use the same type of discontinuous negative marker exemplified by the examples of S. Leonardo reported in the introduction.

- (12) a. *I n a **nia** ody degugn.
 I NEG have not seen no one
 ‘I have not seen anybody.’
- b. I n a ody degugn.
 I NEG have seen no one
 ‘I have not seen anybody.’

Otherwise, there are strong restrictions on the co-occurrence between the two, which cannot be adjacent:^{3,4}

- (13) a. *A'm dis **nen** gnente. (Piedmontese, from Zanuttini 1997)
 SCL me tells NEG nothing
 ‘He does not tell me anything.’
- b. *A veddu **nen** gnun.
 I see NEG nobody
 ‘I do not see anybody.’

Zanuttini (1997) already notes that this type of negative marker occupies a very low position in the functional structure of the clause, as shown by the following examples which exploit the position of low adverbs to show the point:

- (14) a. A l'avia già **nen** volu 'ntlura. (Piedmontese, Zanuttini 1997)
 SCL it had already NEG wanted then
 ‘He hadn't already wanted at that time.’
- b. A l'ha **nen** dine sempre tut.
 SCL it has NEG said always everything
 ‘He has not always said everything.’

³. The same restriction reported by Zanuttini is also described by Parry (1992) for Cairo Montenotte, a dialect spoken at the border between Piedmont and Liguria.

⁴. There might be a relation between the fact that in Piedmontese N-words are compatible with the negative marker (modulo the adjacency restriction), while this is not the case in Rhaeto-romance and the fact that in Piedmontese the negative word ‘nothing’ is different from the negative marker, while in Rhaeto-romance they are identical.

The following detailed structure is the one proposed by Zanuttini on the basis of Cinque's hierarchy of low adverbs.

- (15) [...[T Anterior *already* [Asp Terminative *anymore* [FP *neg* [Asp Perfective *always* [Asp Completive *tutto*]]]]]]]

An additional argument in favour of the hypothesis that q-negation is very low in IP is the fact that in V2 Rhaeto-romance dialects, the negative marker is topicalized to (some) SpecCP together with the verb:

- (16) **Nia** desmentié ne podun-se dōta chë jënt che...
 NEG forget NEG can-we all those people who...
 'We cannot forget those people who...'

In these dialects, q-negation is treated as the negative morpheme which does not trigger any special pragmatics, and is compatible with any verb type or structure and possible with any sentence type in main as well as in embedded domains.⁵ Therefore, we draw the conclusion that it has completely grammaticalized into a true negative marker. Unfortunately, the existing older texts for Piedmontese do not have many instances of negative clauses showing the actual development of q-negation, because the development was already completed around 1500. They only show very generally that Piedmontese *nen* has undergone the Jespersen's cycle. As there are virtually no data from Rhaeto-romance for the relevant time period, we will resort to other varieties where we can observe the process more clearly.

In view of the diachronic path we are trying to establish, we will first examine the behaviour of this negative marker originating from a quantifier in those Italian varieties where it is not (yet) the standard negative marker, but nonetheless is already a negative 'reinforcer' roughly meaning 'at all'. We take modern Venetian and Old Italian (namely Old Florentine) into account.

⁵. One exception is the imperative form in S. Leonardo Rhaetoromance, which is not compatible with *n...* *nia*, but requires a different negative markers. Those speakers who only use *nia* for sentential negation and not the discontinuous form, can have *nia* in imperative contexts. See Poletto and Zanuttini (2003) for a detailed description of this phenomenon.

2.2. An intermediate stage: non standard q-negation

Modern Italian and most Italian dialects have an adverb form *per niente* meaning ‘at all’. The distribution of bare ‘nothing’ in Veneto dialects is restricted, and we think revealing, with respect to the corresponding complex AdvP *per gnente*, which also means ‘at all’. Veneto varieties (where the negative marker is still a preverbal morpheme *no*) have started, but not completed the process of turning the adverb into a real negative marker with negative force of its own. This is the reason why this can be more telling in view of the diachronic process we investigate here.

The syntactic position of the item *gnente* in Venetian is the same as the one reported by Zanuttini for the standard negative marker *nen* in Piedmontese: it occurs after the adverb *più* ‘anymore’, and *zà* ‘already’.⁶

(17) Nol ga più dormio **gnente**, da chela volta. (Venetian)

NEG-SCL has anymore slept nothing since that time
‘Since then, he did not sleep at all anymore.’

(18) Nol dorme zà **gnente**, co tuto sto casin. (Venetian)

NEG-SCL sleeps already nothing, with all this noise
‘There is already the problem that with this noise he does not sleep at all.’

The element *gnente* ‘nothing’ seems *prima facie* incompatible with a direct object of transitive verbs, with unaccusative and passive subjects:

(19) a. Nol lavora **gnente**. (Venetian)

NEG-SCL works nothing

b. Nol dorme **gnente**.

NEG-SCL sleeps nothing

c. *Nol leze **gnente** i libri.

NEG-SCL reads nothing the books

d. *Nol magna **gnente** la me torta.

NEG-SCL eats nothing my cake

⁶ The phenomenon is rather widespread in the Veneto area, in some dialects the item can also occur without the preverbal negative marker, showing that *gnente* cannot be treated as a negative polarity item occurring in a negative concord structure.

- e. *Nol riva **gnente**.
NEG-SCL arrives nothing
- f. *Nol ze sta arestà **gnente**.
NEG-SCL is been arrested nothing

This has recently been noticed for some varieties of English and German by Bayer (2008), who shows that direct objects and adverbial *nichts/nothing* are incompatible and assumes that the negative adverb is actually located in the object position inside the VP. If this were the correct empirical generalization for Venetian too, q-negation would thus be possible only with real intransitive verbs, which have no object as shown in (19). This set of data might at first sight lead the observer to the conclusion that, though q-negation is not an object but an adverbial element, it is still merged in object position (and then moved). This would be the reason why it is incompatible with anything else occupying the object position (either object of transitive verb, unaccusative subjects or passives). However, a closer look at the phenomenon reveals a more complex picture. A subclass of unaccusative verbs are indeed compatible with q-negation, and the same is true of subjects of psych-verbs which, according to Belletti-Rizzi (1988), should be parallel to unaccusatives in having a subject generated in the object position:

- (20) a. No la crese **gnente**. (Venetian)
NEG SCL grows nothing
- b. Nol me piazze **gnente**.
NEG-SCL me likes nothing

The distinction internal to the class of unaccusative verbs is the one proposed by Tortora (1997): inherently directed motion verbs are incompatible with q-negation, while non inherently directed motion verbs are indeed compatible with it.

Moreover, q-negation is not per se incompatible with an element in object position, if the object is a bare plural (defining some sort of activity, like ‘read books’), the combination is indeed possible. Consider the following contrast:

- (21) a. *Nol me leze **gnente** i libri, sto fio. (Venetian)
NEG-SCL to.me reads nothing the books this boy
- b. Nol me leze **gnente** libri, sto fio.
NEG-SCLto.me reads nothing books this boy

One might be lead to think that there is a distinction between definite and indefinite objects, but consider the following example:

- (22) %Nol salta **gnente**. (Venetian)
 NEG-SCL jumps nothing
 ‘It does not jump’.
 OK (said of a long jump athlete) ‘He does not jump much.’

A verb like *saltar* ‘jump’ is intransitive, hence it should be compatible with q-negation. However, it is not, unless the interpretation is one of activity (for instance in the context of a professional long-jump athlete, whose job is to jump). The following contrast is even more illuminating:

- (23) a. Nol zola **gnente**, sto aereo di carta. (Venetian)
 NEG-SCL flies nothing this plane of paper
 ‘This paper plane cannot fly at all.’
 b. *Nol zola via **gnente**, sto aereo de carta.
 NEG-SCL flies away nothing this plane of paper
 ‘This paper plane cannot fly away at all.’

While *zolar* ‘fly’ is an activity, *zolar via* ‘fly away’ is telic, and q-negation is only compatible with the first verb, though in neither of the two cases is there an object. Hence, we cannot conclude that the relevant property in banning q-negation is the presence of an object. Rather, it must be related to some type of aspectual distinction which can be activated by the presence of a definite object, or be intrinsic to the type of verb or required by the presence of some verb modifiers.

That aspect is involved is also shown by cases of activity verbs which can be turned into achievements simply by adding a preposition and forming a phrasal verb. Venetian, just like English has a couple of verbs like ‘eat’ and ‘eat up’: *magnar* and *magnar fora* (literally ‘eat out’) where the first is an activity verb, while the second is an accomplishment verb:

- (24) a. Nol magna **gnente**.⁷ (Venetian)
 NEG-SCL eats nothing
 ‘He does not eat at all.’
 b. %Nol magna fora **gnente**.
 NEG-SCL eats out nothing
 ‘He does not eat up at all.’

The second sentence is impossible in the relevant reading, unless the sentence is interpreted as considering ‘eat up some X’ a habit, hence turning again the verb into an activity one.⁸

Moreover, although all cases of telic verbs, accomplishment and achievement verbs are not compatible with q-negation, notice that also stative verbs, like ‘live’, ‘be’, ‘stay’ are banned with *gnente*:

- (25) *Nol vive **gnente** a Venessia. (Venetian)
 NEG-SCL lives nothing in Venice
 ‘He does not live in Venice at all.’

Therefore, we propose the following empirical generalization:

- (26) q-negation is only compatible with activities.

⁷. This sentence is ambiguous between a reading in which *gnente* is the object of the verb *magnar* and a reading in which *gnente* means ‘at all’. Obviously, we will consider only the second reading.

⁸. Notice however that the distinction cannot simply be one of telicity, as q-negation is not automatically compatible with any atelic verb: *sercar* ‘to look for’ is for instance atelic, but it is still incompatible with the negative quantifier.

- (i) *Nol serca gnente libri.
 NEG-SCL looks-for nothing books
 ‘He does not look for books at all.’

Hence, the fact that *gnente* is incompatible with telic verbs seems to be only a by-product of a deeper property of the negative marker.

We will not enter a semantic explanation here, but rather focus on the fact that the adverbial use of the quantifier is sensitive to aspectual distinctions of the verb. How come this is so? To our knowledge, this has not been reported (at least in Romance) for other types of so called emphatic negation. The reason why this is so is, we think, related to the syntactic position occupied by the quantifier in the clause, which is a very low one in the aspectual field. In what follows we analyze the distribution of object *niente* in Old Italian (namely Old Florentine) and show that it moves from its object position to the low functional domain of the clause where aspectual features are encoded.

2.3. *Niente* in Old Italian

Old Italian has two forms for the bare negative quantifier corresponding to ‘nothing’: *niente* and *nulla*.

- (27) a. Voi non avete fatto **nulla**. (Tristano Riccardiano, 195)
 you NEG have done nothing
- b. E non gli par di aver fatto **niente**. (Cavalca, Esposizione, 1-31)
 and NEG to.him seems to have done nothing

Nulla can act as a negative article and agrees with the noun in number and gender, while *niente* never does:

- (28) a. Come è bella cosa che l’uomo, quasi non potendo essere ferito.
 how is nice thing that the man, almost NEG being.able to be hurt
 da **nulla** saetta, tutte le ‘ngiurie e villanie dispregi.
 by no arrow, all the wrong and villainy dispises
 (Bartolomeo da San Concordio)
- b. De’ quali tornesi non rimettemo **nullo** danaio in ghabella.
 of which *tornesi* NEG put no money in tax
 (Registro S. Maria di Cafaggio 1286)
- c. E dice, che intra li Serafini e Dio **nulli** Angioli altri sono in mezzo.
 and says that among the Seraph and God no other Angels are inbetween
 (Ottimo Commento, 4)

- d. Gli uomini han **nulle** più vili cose che sè medesimi.
 the men have no more vile things than themselves
 (Tesoro volgarizzato da Bono Giamboni, 7-74)

The same form in the masculine, *nullo*, means ‘nobody’ and can have a plural form:⁹

- (29) a. Che **nullo** faccia l’altrui officio.
 that no-one do the other’s work (Capitoli di San Gilio, 2-9)
 b. E con iscala salirono in su le mura che non furono da **nulli** sentiti.
 and with ladder climb on top the walls that NEG were from no-one.PI heard
 (Giovanni Villani, Nuova Cronica, 11-59)

Only the uninflected form *niente* can have an adverbial usage with the approximate meaning of ‘at all’:

- (30) a. Questo cotale uomo sie certo che non t’ama **niente**. (Z. Bencivenni)
 this such man be sure that NEG you loves nothing
 b. E non dormono **niente**. (Bono Giamboni, Vizi e Virtudi, 11)
 and NEG sleep nothing
 c. Per ciò non si rallegrò **niente**. (Giovanni Villani, Nuova Cronica, 9-63)
 for this NEG REFL rejoiced nothing

Both forms can occur either in front of the past participle yielding optional OV order:

- (31) a. E’ non potrà tener **nulla** nascoso. (Dante, Fiore, 159)
 he NEG will.be.able to.keep nothing ridde
 b. Quando un altro gli domandò s’egli avea perduto **nulla**.
 when another him asked if he had lost nothing
 (Tesoro volgarizzato da Bono Giamboni, 7-3)

⁹. The form *nullo/a* is omophonous with the adjective meaning ‘invalid’ and as such it is found in predicative position:

- (i) Le patte sono nulle. (Tesoro volgarizzato da Bono Giamboni, 2-48)
 ‘Draws are invalid.’

This is true both when *niente* is the object and when it is as an adverb:¹⁰

- (32) a. Per lo dì d'oggi, non abbiamo ancor mangiato **niente**. (Tavola ritonda, 57)
 for the day of today NEG have yet eaten nothing
- b. Io non avea **niente** letto tanto v'avea ancora a legere.
 I NEG had nothing read so.much there had yet to.read
 (Storia del San Gradale, 5)
- c. Coloro che non àno **niente** saputo di letera. (Storia del San Gradale, 131)
 those who NEG have nothing known of letter
- (33) a. Queste laude intes'io bene, ma di tute l'altre no pote' io **niente** intendere.
 these praises understood I well, but of all the others NEG could I nothing
 understand (Storia del San Gradale, 7)
- b. Una cosa non si dee **niente** dimenticare.
 a thing NEG one must nothing forget
 (Tesoro volgarizzato da Bono Giamboni, 9-4)
- c. Egli non dovrebbe essere biasimato **niente**.
 he NEG should be blamed nothing
 (Tesoro volgarizzato da Bono Giamboni, 7-26)

We assume that the pre-participial position of the quantifier illustrated by the examples above is a dedicated position, as already proposed by Svenonius (2000). He describes the system of residual OV cases in Icelandic and provides arguments in favor of the idea that the cases of OV orders with negative quantifiers are instances of quantifier raising. He shows that these OV cases obey the typical restrictions of A' movement, like sensitivity to weak crossover violations, licensing of parasitic gaps, and no new binding possibility for anaphora. He further notices that QR is obligatory with negative quantifiers, while only optional (or for some speakers even ungrammatical) with other types of quantifiers.

A similar case in Romance quoted by Svenonius is the one of French *rien* (see a.o. Kayne (1975) and Obenauer (1998)). Kayne (1975) shows that French *tout/tous* 'everything' *chacun* 'each' and *rien* 'nothing' move from the VP internal position to a higher one crossing the past participle (or the infinitival verb selected by a modal).

¹⁰. I follow here Cinque's (2001) idea that constructions with modals and infinitival verbs are monoclausal in Romance, therefore examples with infinitival verbs or past participles are treated alike.

Therefore the bare negative quantifier must occur to the left of the past participle, yielding OV, contrary to normal DP objects which are only VO:

- (34) a. Il n'a **rien** préparé.
 he NEG has nothing prepared
 b. *Il n'a préparé **rien**.
 he NEG has prepared nothing

Kayne explicitly states the transformation rule in terms of the category of quantifiers and connects the OV positioning of object quantifiers to the phenomenon of quantifier floating.

Cinque (1999) also shows that the quantifier *tutto* in modern Italian has a special dedicated position in the low IP portion, it is located in the specifier of Completive Aspect, higher than the adverb *bene* 'well', located in VoiceP. The basic argument in favor of this analysis is that *tutto* must precede *bene* in an unmarked construction without any special focus.

Grewendorf and Poletto (2005) show that Cimbrian, a Germanic dialect spoken in the Italian Alps, is a VO language when the object is a DP, but the last cases of OV order retained by this language are precisely those with bare quantifiers. All these cases show that all bare quantifiers (even 'something', as Cimbrian shows) can move to dedicated position outside the VP but still in the lower space for aspectual adverbs. There are other languages where quantifiers move in the syntax and we will not list them all here, we only notice that often negative quantifiers move more frequently than others (as noted by Svenonius), and that bare quantifiers are more prone to move than quantified DPs (as shown by Cimbrian). Beghelli and Stowell (1997) propose that there are at least three positions (RefP, ShareP and DistributiveP) where quantifiers can move, and that their scope properties derive from the position where the quantifier moves. The idea that different types of quantifiers move to different positions is also present in Haegeman (1995), who shows that there is a negative field to which negative quantifiers have to move in West Flemish.¹¹

¹¹. Brugger and Poletto (1995) make the same point on the basis of negative concord between the negative marker *nit* and k-words in Bavarian dialects, showing furthermore that the positions for negative quantifiers are all below the negative adverb *nie*, 'never'.

Therefore, in order to interpret the diachronic path of q-negation we will assume that a) quantifiers move to dedicated positions b) there is not a single position for all types of quantifiers, but several, each related to one type of interpretation.¹²

We will make the null hypothesis here that the OV instances with *niente/nulla* in Old Italian are similar to the other cases reported by Svenonius for Icelandic and Obenauer for French, though it is impossible to test sensitivity to weak crossover, parasitic gaps and binding possibilities with anaphora for obvious reasons.¹³ Like in Icelandic, Cimbrian and French, the Old Italian bare quantifier *niente/nulla* can raise to a quantifier dedicated position crossing the past participle and yielding OV orders in a VO language.¹⁴

Notice that this is true irrespective of the value of the quantifier, which can either be an object or have adverbial usage, as the examples above show. Probably, the only difference between the two structures is the null copy in object position in the case of (33a), which is not present when *niente* has an adverbial meaning.

The position dedicated to the negative quantifier is evidently not a very high one as it occurs after the inflected verb in embedded clauses (Old Italian is a V2 language with verb movement to T° in embedded clauses; see Benincà (2006) on this). The generalization found for q-negation in Veneto dialects is evidence in favor of this idea: the quantifier moves to the aspectual field because there is a Q-position in that area (as

¹². It is beyond the scope of this article to investigate the positions of each type of quantifiers, but notice that Beghelli and Stowell propose that the landing sites of quantifiers, namely RefP, DistP and ShareP are all higher than NegP. The fact that negative quantifiers are more frequently moved than other types might indeed suggest that the position(s) for negative QPs is lower than that for other types. This is actually what our data also indicate.

¹³. The database used here is the one of the OVI (Opera del Vocabolario Italiano) which contains all Old Italian texts. The occurrences of *niente* are 1914 in the corpus, but unfortunately there is no example with parasitic gaps, or binding relations that we can use as evidence.

¹⁴. We have tried to find occurrences of adverbial *niente* with adverbs in Old Italian, but we have not found any. The OVI data base has 24 cases of *più niente* and 1 case of *ancora niente* where *niente* is the object and no cases of *niente più* or *ancora più* as our analysis predicts. No cases of *niente bene* or *niente bene* exist in the corpus.

shown by several languages) and there it interacts with aspectual features.¹⁵ The crucial observation we have made on the basis of Old Italian is that movement to the aspectual field is not only possible in the case of adverbial *niente* but also for the direct object, as shown by Old Italian, Icelandic, French and Cimbrian. This is in a sense similar to Bayer's proposal because the position of the object and that of the adverb are the same, but reverses his perspective: it is the object which can raise to a quantifier position which can also be occupied by the adverb, not the adverb which is generated in object position.

The general conclusion of our analysis is that the position of the negative marker *nen* in Piedmontese, of adverbial *gnente* in Veneto and of object *niente* in Old Italian is always the same and it is a dedicated position to quantifiers. Therefore, this type of negative marker has never changed its original position as it often happens in cases of grammaticalization.

3. Minimizer negation

3.1. M-negation in modern dialects

Many Italo-romance varieties display negative markers which derive from nouns expressing a small quantity, which were originally lexically related to their complement PP. We adopt here the term 'Minimizer Negation' to indicate these elements (from now on simply m-negation). A partial list of m-negations, with their original referential meaning, is given in (35):

- (35) 'step': Piedmontese/Valdotain *pa*;
 'crumble': Emilian *brisa*; Milanese *miga/minga*; Veneto *mina/mia*; Italian *mica*;
 'bite': Romansh *bucca*; Livigno Lombard *ca*;
 'point': Florentine *punto*;
 'thread': Salentino *filu*;
 'flower': Old Florentine *fiore*;
 'drop': Old Venetian *gozo*.

¹⁵. We will not further pursue the problem concerning the interaction with Aspect here and concentrate rather on the comparison between the diachronic path of m-negation and q-negation.

Some of these elements have become negative markers (like *pa* in some Piedmontese dialects, *ca* in Livigno Lombard, or *bucca* in Romansh), while others have specialized as reinforcers of negation. There are two main groups of reinforcers of negation: on the one hand, adverbs which can be considered as equivalent to ‘at all’ in English - on the other hand, negative morphemes that are used to express the fact that an explicit or implicit assumption made by the interlocutor is wrong.¹⁶ The difference between these two types is shown in (36), which also shows that dialects can have more than one type of reinforcer of negation.

- (36) a. Mario un ha **punto** mangiato. (Modern Florentine)
 M. NEG has NEG eaten
 ‘M. has not eaten at all.’
- b. Mario un ha **mica** mangiato. (Modern Florentine)
 M. NEG has NEG eaten
 ‘M. has not eaten (as you have said/think).’

M-negations behave like a natural class of elements, since they display common syntactic properties. Usually they appear higher than adverbs encoding Aspect and Tense Anterior, this position is occupied by both standard negative markers and reinforcers of negation. Zanuttini (1997) proposes that this position is the specifier of a functional projection which she labels Neg2. Some examples which show that m-negations precede adverbs corresponding to ‘already’ are given in (37)¹⁷, while the relevant part of the clause structure of Zanuttini’s analysis (based on Cinque’s (1999) hierarchy of adverbials) is provided in (38):

- (37) a. A l’ha **pa** gia ciamà. (Piedmontese, from Zanuttini 1997)
 SCL SCL has NEG already called
 ‘He has not already called.’
- b. I n’an **briza** beli ciamà. (Emilian, from Colombini 2007, § 5.6.1)
 SCL NEG have NEG already called
 ‘They have not already called.’

¹⁶. See Cinque (1976) and Penello-Pescarini (2008) for a detailed discussion about the interpretation of *mica* in Standard Italian and other elements of this type.

¹⁷. See also the examples in the introduction.

- c. Non hanno **mica** già chiamato. (Italian, from Cinque 1999)
 NEG have NEG already called
 ‘They have not already called.’
- d. Elts an **buca** magliau trasora. (Romansh, from Manzini-Savoia 2005)
 SCL have NEG eaten already
 ‘They have not already eaten.’

(38) [...[FP *neg* [T Anterior *already* [Asp Terminative *anymore* [Asp Perfective *always* [Asp Completive *tutto*]]]]]]]

Contrary to q-negations, m-negations can be adjacent to negative quantifiers. Notice that this behavior contrasts with that of French *pas*, which, even if it derives from a minimizer, cannot co-occur with a negative quantifier.

- (39) a. A ’m dis **pa** gnente. (Piedmontese, from Zanuttini 1997)
 SCL me tells NEG nothing
 ‘She does not tell me anything.’
- b. A veddu **pa** gnun. (Piedmontese, from Zanuttini 1997)
 SCL see neg nobody
 ‘I do not see anyone.’
- c. Al n’i **briza** arivà endsun. (Emilian, from Colombini 2007, § 2.3)
 SCL NEG is NEG come nobody
 ‘Nobody has come.’
- d. A n vegn **mia** ninsün. (Mantuan, from Manzini-Savoia 2005)
 SCL NEG comes NEG nobody
 ‘Nobody comes.’

The postverbal position of m-negations is the same in varieties which have (40a-b) and varieties which lack (40c-d) a preverbal negative marker:

- (40) a. Non sente **mica**. (Italian)
 NEG hears NEG
 ‘He cannot hear.’
- b. No ssienti **filu**? (Salentino, from Rohlf’s 1969)
 NEG hear NEG
 ‘Don’t you hear?’

- c. Lo film l'ëra **pa** dzen. (Valdotain, from Zanuttini 1997)
 the movie SCL was NEG beautiful
 'The movie wasn't good.'
- d. El l'ha **minga** scrivuu. (Milanese, from Zanuttini 1997)
 He SCL has NEG written
 'He has not written.'

However, in some varieties where the marker of standard negation is preverbal, m-negations can optionally appear in preverbal position. In this case, m-negation is the only negative element in the sentence (leaving aside additional n-words after the verb, as in (41c)), although it most probably does not occupy the same position of the preverbal negative marker, which is a head. We can explain these facts assuming that these elements carry an interpretable [Neg] feature or form a compound with the negative operator in preverbal position, as in Zeijlstra's (2004) analysis of Negative Concord languages:

- (41) a. **Mica** sente quello che dici. (Italian)
 NEG hears that that say
 'He does not hear what you are saying.'
- b. **Filu** sapimu la libbirtà. (Salentino, from Rohlfs 1969)
 NEG know the freedom
 'We don't know what freedom is.'
- c. **Mica** abbiamo visto nessuno. (Italian)
 NEG have seen nobody
 'We have not seen anybody.'

These examples show that reinforcers of negation like *mica* and *filu* can yield sentential negation and, therefore, have negative semantics. Thus we can consider them as negative markers.

3.2. Development of M-Negations

All m-negations we deal with in this paper derive from nominal minimizers, that is nouns denoting "a negligible number, amount, or part of something" (Kiparsky-Condoravdi 2006, 2). In origin they appeared in semantically restricted predicates (as,

for example, ‘not eat a crumble of bread’, ‘not drink a drop of water’, not move an inch (a step), etc.). In these contexts they were indefinite DPs with a prepositional complement containing another DP (the noun referring to the minimally quantified thing). These expressions can be described as emphatic negations, where emphasis is obtained negating the smallest grade of a scale. However, the minimizer retained its referential value, as shown by the lexical restriction imposed on it by the verb.

Examples of this type of quantity nouns exist in modern Italian (as in most languages), where the lexical restriction is retained:

- (42) a. Non ha bevuto neanche **una goccia** di alcool.
 NEG has drunk not-even a drop of alcohol
 ‘He did not drink a drop of alcohol.’
- b. Non ho incontrato **un cane**.
 NEG have met a dog
 ‘I met nobody.’

In (42a) the usage of *goccia* ‘drop’ is only a possible minimizer for liquids, while ‘dog’ in (42b) is the minimizer for animates. Vulgar minimizers also belong to this class of quantity nouns (see Postal 2003), and share several properties with m-negations in their first evolutionary stage. Vulgar minimizers differ from standard minimizers in the fact that the last “denote minimal elements on some scale”, while the former “are not narrowly restricted to particular dimensions, but can express minimality along many dimensions” (Postal 2003).

However, they behave as minimizers in that they can be modified, for example by adjectives, and can have PP complements (in this case, they have quantificational function over the noun inside the PP).^{18,19}

¹⁸. In varieties of Central Italy, it is possible to use vulgar minimizers as the unique negative element of a clause:

- (i) a. So un cavolo chi viene stasera.
 know a cabbage who comes this evening
 ‘I do not know who will come this evening.’
- b. Sono indipendenti un cavolo.
 are independent a cabbage
 ‘They are not independent.’

- (43) a. Non ho capito **un emerito tubo**.
 NEG have understood a emeritous pipe
 ‘I have understood nothing.’
- b. Non capiscono **un tubo di economia**.
 NEG understand a pipe of economics
 ‘They understand nothing of economics.’

This initial stage can be analyzed by adopting Giusti and Leko’s (2005) typology of quantity expressions: minimizers in the first stage of their development can be described as Quantity Nouns.

Looking at the evolution of minimizers through Italo-Romance varieties, we see that the first attested stage is already beyond the lexical one exemplified by (42) and (43). The examples in (44) show that the minimizer *miga* in Old Milanese does not obey any lexical restriction, as it corresponds to the word ‘crumble’ and is associated with a liquid ‘wine’ in (44a) and with an abstract noun in (44b).²⁰

- (44) a. On sté de scisceri e **miga** de vin d’intrà. (Lancino Curti 6-14)
 one staio of chickpeas and MIGA of wine of income
 ‘One staio (20 l) of chickpeas and a little of wine as income...’
- b. Là no se sente **miga** de male. (Barsegapé 2430)
 there NEG REFL feels MIGA of pain
 ‘There one does not feel any pain.’

They are a very peculiar class of elements: on the one hand, they are in some sense more similar to nouns, since they can be modified and can take PP complements, what is not possible anymore for m-negations; on the other hand, they can be the unique negative element in a sentence, even in those varieties where the actual negative marker is preverbal. We leave a deeper analysis of these elements to future research, but it is clear that they must be considered together with m-negations and in some sense they appear to be in one of the precedent stages of the historical development of minimizers into m-negations.

¹⁹. Notice that Postal (2003) argues that vulgar minimizers (at least in American English) are not negations. Furthermore, they never become the standard negation, while many varieties in Northern Italy have a standard m-negation. This fact could be related to their connotative meaning, which seems to be incompatible with pure functional items.

²⁰. On negation in Old Milanese see Vai (1996).

In this second step of the grammaticalization process, these elements are real quantifiers. A crucial property at this stage is that they do not receive obligatory negative interpretation and can be used in positive contexts as well: the context is positive in (44a), while in (44b) it is negative.

The development from Quantity Nouns to Quantifiers can be represented as in (45):²¹

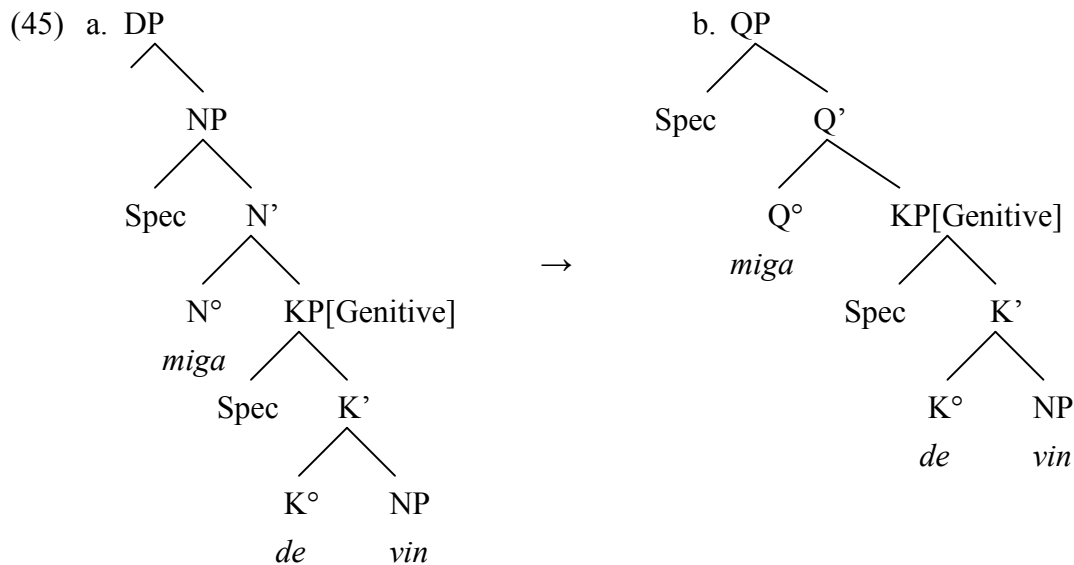

At this point the minimizer has become a functional element and loses the typical properties of lexical nouns: its phi-features, the possibility of being modified, the possibility of taking PP complements and, more in general, any referential content. Standard Italian *mica*, which is a reinforcer of negation and derives from the Latin word for ‘crumble’ (*micam*) has lost all these properties. It cannot be modified (46a), cannot have a PP complement (46b) and cannot be used to express its original referential meaning (46c):

- (46) a. Non leggono (*la minima) **mica** i libri gialli.
 NEG read the minimal NEG the books yellow
 ‘They do not read police novels.’

²¹. An intermediate stage could be one in which the minimizer raises inside its DP to a [Num] position containing a silent numeral, as proposed by Déprez (1995; 1997) and Roberts and Roussou (2003) for French *n*-words, with the difference that in these cases the numeral does not correspond to *zero*, since the minimizer wasn’t intrinsically negative.

- b. Non vedo **mica** (*di) Mario questa sera.
 NEG see NEG of Mario this evening
 ‘I will not meet Mario this evening.’
- c. *...una **mica** di pane.
 a MICA of bread

In some dialects traces of the original structure can still be found. For instance, in the Alpine Lombard variety of Quarna Sotto, when the m-negation *mia* is used, the object can appear in the genitive (partitive) case, even if it expresses a singular non-quantifiable entity:

- (47) Nə caman **mia** d əu te frial. (Quarna Sotto, from Manzini-Savoia 2005)
 NEG-SCL call NEG of the your brother
 ‘They do not call your brother.’

After having become a functional element, the minimizer can undergo a further change: it is moved outside the object position where it was merged in origin. The reason of this movement is the same we have seen above for q-negation: quantifiers move to dedicated positions in the low portion of IP even when they represent the object of the verb. At this stage the minimizer can appear alone, without any complement. We will use some examples with Old Italian *punto* in the following discussion. *Punto* can appear alone already in Old Italian (that is Old Florentine), as it is shown by the following examples:

- (48) a. Perch’elli vive bestialmente, ed usa con quelli che bestialmente vivono, né da
 because he lives beastly and stays with those that beastly live and-NEG from
 loro **punto** si parte.
 them PUNTO REFL separates
 (Ottimo Commento, 19)
 ‘...because he lives as a beast and stays with those that live as beasts and does
 not separate from them.’
- b. In tutta la detta oste non ebbe altra gente che **punto** reggesse o combattesse.
 in all the said army NEG was other people that PUNTO resist or fight
 (G. Villani, Nuova Cronica, 11-216)
 ‘In all the foresaid army there was not anyone who did not resist or fight.’

Notice that at this stage *punto*, when used alone, is already in the position where m-negations are found, since it precedes adverbs corresponding to (*not*) *yet*, which, according to Cinque (1999), is in the same position of *already*, or a very close one. The reverse order is not attested.

- (49) Elleno non poteano **punto** ancora essere trovate. (Difenditore della Pace)
 they NEG could PUNTO yet to.be found
 ‘They could not be found yet.’

However, in Old Florentine it is still possible to find the structure *punto di*. This suggests that the minimizer has not become a negative marker yet:

- (50) Il re d’Inghilterra fu a gran pericolo con sua oste [...] che 8 dì stettono, che non
 the king of England was at great peril with his army that 8 days stayed that NEG
 ebbono se non poco pane né **punto** di vino.
 had but NEG little bread and-NEG PUNTO of wine
 (G. Villani – Nuova Cronica 13.66)
 ‘The king of England was in great peril with his army, since for 8 days they had
 not but a little of bread and had no wine.’

But in Literary Italian of the XVII and following centuries, which derives mainly from Old Italian, *punto* is always used alone, even if a quantifiable argument is present (which would require *punto di* in the previous stages of the language):

- (51) a. Quanto a me, non ne ho **punto** inquietudine.
 as to me NEG of-it have PUNTO disturb
 (P. Verri - Dialogo fra l’Imperatore Giuseppe II e un filosofo)
 ‘As for me, I am not disturbed at all by it.’
 b. (Non ho) **punto** paura!...Piuttosto morire, che bere quella medicina cattiva.
 NEG have PUNTO fear rather to-die than to-drink that medicine bad
 (Collodi – Pinocchio)
 ‘I have no fear. Better to die than drink that bad medicine.’

As we have seen, m-negations occupy a precise position in the adverbial hierarchy, which is higher than Tense Anterior. At this point, the element originally quantifying over a DP has become a sentential element. Both standard m-negations and m-negations

used as reinforcers appear in this position, which, therefore, seems to be irrelevant in order to distinguish between quantifiers and different semantic types of negation.

4. A comparison between m-negation and q-negation

We now go back to the original problem posed in the introduction. Is the diachronic evolution into negative markers of different postverbal XPs which appear to have undergone Jespersen's cycle the same, or is it different? We propose that the final positions of the two types of negative markers depend on their original status.

We have observed that minimizers are originally real DPs which take a complement genitive PP and can be modified by adjectives as any noun. We propose that the first step of the reanalysis is the one in which the minimizer is not the head noun anymore, but is turned into a quantifier of the DP whose lexical N is the original complement of the minimizer. At this point it can no longer be modified by adjectives or have a determiner. We have adopted Giusti and Leko's (2005) idea that quantity nouns and quantifiers are two different categories: in the case of minimizers the quantity noun becomes a quantifier. At this stage, the minimizer can raise to its dedicated position²² but is still in the scope of the actual negative marker (which is the preverbal one). This is the stage documented by Old Italian. At a later stage, the minimizer itself is reanalyzed as the actual negative marker, but from this point on, it just stays in its dedicated position. This stage is the one observed in modern dialects. So, the final position of the m-negative marker is still the one occupied by minimizers when they were quantifiers.

The path q-negation undergoes is different, as the original item is already from the beginning a negative quantifier, not a quantity noun. Therefore, it already raises to its dedicated position in the low IP portion (yielding OV orders in VO languages as Old Italian) and never changes its position. Given that the object quantifier already moves to a position inside the Aspectual field, reanalysis simply cancels the trace in object position and q-negation is directly merged in the FP where negative QPs move. This is the stage of modern dialects.

As the two original positions for minimizer and negative quantifiers are different, it follows that the position of the negative markers deriving from them will be different.

²². It is possible to think that minimizers are a special case of existential quantifiers, we will not discuss this here.

This amounts to saying that the positions where the negative markers occur are not to be labelled as NegP, which would then have the bizarre property of occurring at different heights in the sentence structure before TP1, before TP2, before or after AspP, contrary to all other functional projections CP, TP, AspP etc. which always come in the same order. No other functional projection seems to be able to jump around in the sentence as NegP is supposed to do. If our analysis of the diachronic path of m- and q-negation is correct, the positions where the negative markers are hosted are not intrinsically NegPs, but they are still the specifiers hosting different types of quantifiers, namely what the negative markers used to be at an earlier stage of evolution.

5. Conclusion

In this work we have taken into account minimizers and the quantifier ‘nothing’ which become negative markers and have traced their diachronic path. A common property of the two types of elements is that they both start out as objects. In the case of m-negation, a noun becomes a quantifier and then raises to a position dedicated to quantifiers higher than Anterior Tense. In the case of q-negation, the element, being a negative quantifier, is already located in the functional space of the past participle and remains where it is. In this case reanalysis does not correspond to syntactic movement to a higher functional projection as it often happens in grammaticalization (see Roberts and Roussou (2003)). If our analysis is correct, it has the consequence that the two positions are not to be labelled as NegPs. They are the original quantifier positions of the two elements from which the two types of negative markers originate. If this analysis were to be extended to other types of negative markers, we could discover that there are not several NegPs in the clause, but at most one.

References

- Bayer, J. 2008. "Nominal negative quantifiers as adjuncts". Ms., University of Konstanz.
- Beghelli, F. & T. Stowell. 1997. "Distributivity and negation: the syntax of *each* and *every*". In A. Szabolcsi (ed.), *Ways of Scope Taking*. Dordrecht: Kluwer, 71-109.
- Belletti, A. & L. Rizzi. 1988. "Psych-verbs and Theta Theory". *Natural Language and Linguistic Theory* 6, 291-352.
- Benincà, P. 2006. "A Detailed Map of the Left Periphery of Medieval Romance". In R. Zanuttini, H. Campos, E. Herburger & P. Portner (eds.), *Negation, Tense and Clausal Architecture: Cross-linguistics Investigations*. Georgetown: Georgetown University Press, 53-86.
- Brugger, G. & C. Poletto. 1995. "On Negation in German and Bavarian". *Rivista di Grammatica Generativa* 20, 111-159.
- Cinque, G. 1976. "Mica". *Annali della Facoltà di Lettere e Filosofia dell'Università di Padova* 1, 101-112.
- Cinque, G. 1999. *Adverbs and Functional Heads: A Cross-Linguistic Perspective*. New York & Oxford: Oxford University Press.
- Cinque, G. 2001. "Restructuring and the order of aspectual and root modal heads". In G. Cinque & G. Salvi (eds.), *Current Studies in Italian Syntax*. Amsterdam: Elsevier, 137-155.
- Colombini, F. 2007. *La negazione nei dialetti emiliani: microvariazione nell'area modenese*. University of Padua, MA Thesis.
- Déprez, V. 1995. "The roots of Negative Concord in French and French based creóles". In M. De Graff (ed.), *Language Creation and Language Change*. Cambridge, MA: MIT Press, 329-375.
- Depréz, V. 1997. "A non-unified Analysis of Negative Concord". In D. Forget, P. Hirschbühler, F. Martineau & M.L. Rivero (eds.), *Negation and Polarity. Syntax and Semantics*. Amsterdam: Benjamins, 53-74.
- Giusti, G. & N. Leko. 2005. "The categorial status of quantity expressions". In N. Leko (ed.), *Linguistički Vidici*. Sarajevo: Ed. Forum Bosne, 121-184.
- Grewendorf, G. & C. Poletto. 2005. "Von OV zu VO: ein Vergleich zwischen Zimbrisch und Plodarisch". *Diversitas Linguarum* vol. 9. Bochum: Universitaetsverlang Brockmeyer.
- Haegeman, L. 1995. *The Syntax of Negation*. Cambridge: Cambridge University Press.
- Kayne, R. 1975. *French Syntax*. Cambridge, MA: MIT Press.

- Kiparsky, P. & C. Condoravdi. 2006. "Tracking Jespersen's Cycle". In M. Janse, B. D. Joseph & A. Ralli (eds.), *Proceedings of the 2nd International Conference of Modern Greek Dialects and Linguistic Theory*, Mytilene: Doukas.
- Manzini, M.R. & L.M. Savoia. 2005. *I dialetti italiani e romanci: morfosintassi generativa*. Alessandria: Edizioni dell'Orso.
- Obenauer, H.G. 1998. "Negative Movement in French". Talk, *Going Romance 1998*, Utrecht University.
- Parry, M.M. 1992. "Innovazione e conservazione nell'entroterra savonese: appunti di morfosintassi valbormidese". In G. Petracco Sicardi (ed.), *L'anfizona ligure-padana*. Alessandria: Edizioni dell'Orso, 49-72.
- Parry, M.M. 1996. "La negazione italo-romanza: variazione tipologica e variazione strutturale". In P. Benincà, G. Cinque, T. De Mauro and N. Vincent (eds.), *Italiano e dialetti nel tempo*. *Saggi di grammatica per Giulio C. Lepschy*. Roma: Bulzoni, 225-257.
- Penello, N. & D. Pescarini. 2008. "Osservazioni su mica in italiano e alcuni dialetti veneti". *Quaderni di lavoro dell'ASIt* 8, 43-56.
- Poletto, C. & R. Zanuttini. 2003. "Marking Imperatives: Evidence from Central Rhaetoromance". In C. Tortora (ed.), *The Syntax of Italian Dialects*. New York & Oxford: Oxford University Press, 175-206.
- Postal, P.M. 2003. "The Structure of One Type of American English Vulgar Minimizer". In *Skeptical Linguistic Essays*, (§ 5). New York & Oxford: Oxford University Press.
- Roberts, I. & A. Roussou. 2003. *Syntactic Change: A minimalist Approach to Grammaticalization*. Cambridge: Cambridge University Press.
- Rohlf, G. 1969. *Grammatica storica della lingua italiana e dei suoi dialetti III: Sintassi*. Torino: Einaudi.
- Svenonius P. 2000. "Quantifier Movement in Icelandic". In P. Svenonius (ed.), *The Derivation of VO and OV*. Amsterdam: Benjamins, 255-292.
- Tortora, C. 1997. *The Syntax and Semantics of the Locative Expletive*. Ph.D. thesis, University of Delaware.
- Vai, M. 1996. "Per una storia della negazione in Milanese in comparazione con altre varietà altoitaliane". *ACME* 49.1, 57-98.
- Zanuttini, R. 1997. *Negation and Clausal Structure*. New York & Oxford: Oxford University Press.
- Zeijlstra. H.H. 2004. *Sentential Negation and Negative Concord*. Utrecht: LOT Publications.

A Grammar of Italian Sequence of Tense

Alessandra Giorgi

University of Venice

1. Introduction

Sequence of Tense can be conceived of as the set of rules determining the appearance of a certain particular verbal form in a subordinate clause, depending on the form present in the superordinate one. Traditionally, languages have been divided into two groups: languages that have sequence of tense and languages that don't. For instance Latin and Italian are taken to belong to the former group, whereas Russian and Romanian to the latter. In this work, I will not follow this tradition and will assume that all languages have Sequence of Tense (henceforth SoT), because all languages seem to have rules determining the form and interpretation of an embedded verb, even if there might be significant differences between the two groups.

In this article I will discuss only Italian, but I will signal where the differences lie with respect to the languages belonging to the other group.

The properties of Italian verbal form have mostly been considered in isolation.¹ The discussion of Sequence of Tense in Italian has been addressed only recently –see Giorgi

¹. Among the works in a synchronic framework see Bertinetto (1986, 1997), Giorgi and Pianesi (1997), Delfitto and Bertinetto (2000) Bertinetto and Delfitto (2000), Ippolito (2004), Bianchi et Al. (1995), Zucchi (2001), Bonomi and Zucchi (2001). For an exhaustive list of references, see Binnick's web site, totally devoted to references on tense and aspect, updated 2006:
<http://www.uts.utoronto.ca/~binnick/TENSE/Bibliography.html>.

and Pianesi (2000, 2001a) and Giorgi (2010)– and almost exclusively with respect to complement clauses.²

This article is organized as follows: In section 2, I address the issues concerning indicative complement clauses. In section 3, I consider the distribution of embedded subjunctive. In section 4, I briefly outline a theoretical account for the observed phenomena, illustrating the main hypothesis of this article – namely, that the speaker’s temporal coordinate is represented in the left-most position in the C-layer and that its presence –or absence– is crucial in determining the distribution of embedded forms. In section 5, I take into account an apparent exception to the hypothesis, constituted by the temporal interpretation of complement clauses embedded under a main future verbal form. In section 6, I consider the temporal interpretation for both indicative and subjunctive verbal form in relative clauses and finally, in section 7, I draw some conclusions.

2. Indicative complement clauses

In Italian the verbal form of a complement clause can bear the indicative morphology, the subjunctive one –where both the indicative and the subjunctive are finite verbal forms, in that they show agreement with the subject, even if to a different extent– or can be expressed by means of an infinitive. In this work, I will not consider the infinitive option, but focus only on the finite ones. In particular, in this section I consider indicative forms under a past, whereas I will discuss the properties of clauses complement to a main future in section 5 below.³

The main clause can be past, present or future and the embedded one exhibits the same range of possibilities.

The most salient feature of SoT in indicative clauses is the existence of the Double Access Reading (henceforth, DAR), typically emerging when an (indicative) present tense is embedded under a past. Consider the following examples:

². With respect to the analysis of other languages, in particular English, see among the others, Zagana (1995), Schlenker (2003, 2005), Stowell (1996), Ogihara (1995, 1996), Higginbotham (1995, 2001).

³. For a discussion of indicative vs. subjunctive and infinitive embedded clauses, see Bianchi (2006).

- (1) Gianni ha detto che Maria è incinta
Gianni said that Maria is(PRES IND) pregnant

The main verb is a past verbal form and embedded one is a present indicative. The meaning of this sentence entails that the state of pregnancy attributed to Maria must hold at the time of the saying by Gianni, so that (1) is a faithful report of the following direct discourse by Gianni:

- (2) “Maria è incinta”
“Maria is pregnant”

Sentence (1) in Italian, however, also necessarily implies that at the time the speaker is uttering it, Maria is still pregnant. Hence, the following sentence is infelicitous:

- (3) #Due anni fa Gianni ha detto che Maria è incinta
Two years ago Gianni said that Maria is pregnant

Since we know about the timing of human pregnancy, we cannot conceive of Maria being pregnant at the time Gianni said it – two years ago – and *now* – i.e., at the time the speaker is speaking. This shows that the interpretation assigned to the embedded present tense is actually obligatory, to the extent of reducing the range of acceptable sentences. This phenomenon has been dubbed in the literature on the topic as *Double Access Reading*, because the embedded verbal form, in the language exhibiting this property, must access two different temporal points to be interpreted: the time of the event of the main clause – in this case the saying by Gianni – and the utterance time.

This is not a universal property. Some languages are like Italian –among the others, for instance, English, French, Spanish and Catalan– and some languages are not –for instance, Russian, Romanian, Chinese and Japanese.

Languages belonging to the latter group do not exhibit the second part of the interpretive rule described above. The embedded verbal form must only be interpreted with respect to the temporal location of the superordinate event. Consider for instance the following Romanian examples:⁴

⁴. I thank Iulia Zegrean, a PhD. student at Ca' Foscari, for the Romanian data.

- (4) Maria e insarcinata.
Maria is(PRES IND) pregnant
- (5) (Acum 2 ani) Gianni a spus ca Maria e insarcinata.
(Two years ago) Gianni said that Maria is(PRES IND) pregnant

The present tense is the form used in main sentences to express simultaneity with the utterance time. But in Romanian, the equivalent of sentence (1), i.e., (5), has the same meaning as sentence (6) in English, or (7) in Italian:

- (6) (Two years ago) John said Mary was pregnant
- (7) (Due anni fa) Gianni ha detto che Maria era(IMPF) incinta

In other words, in Romanian the embedded event does not have to be located with respect to the utterance time.⁵ The nature and the properties of the DAR have been variously considered in the literature on the topic. Here I will briefly summarize some of the most prominent positions.

2.1. The Double Access Reading

An important question with respect to the DAR concerns a typological observation. An *a priori* possible language type is missing in the inventory of the existing temporal interpretations of (1). In this sentence, as pointed out before, two different times can be considered as relevant to the interpretation of the embedded clause: The utterance time and the time of the event of the superordinate clause – i.e., the time of the saying. There

⁵. Note that the embedded event can be *persistent*, to the extent that the state *might*, but does not *have to*, still hold at utterance time. Consider for instance the following Romanian sentence:

- (i) Gianni a spus ca Maria e insarcinata.
Gianni said that Maria is(PRES IND) pregnant

Nothing prevents the state of pregnancy of Maria to hold *now*. Note however that this state of affair is different from the one described above for Italian, where this is an *obligatory* part of the interpretation, so that sentence (3) is infelicitous in Italian, and in English as well, but is fine in Romanian.

are languages that have to obligatorily consider both of them, as for instance English and Italian. There are languages for which only the time of the superordinate event is relevant, as for instance Romanian and Japanese.⁶

No language exists in which the only time to be considered for the interpretation of the embedded clause is the utterance time. In other words, in no language a clause embedded as a complement, has exactly the same interpretation it has in isolation. Namely, (1) cannot mean that Mary is pregnant *now* –which is meaning of the sentence “*Mary is pregnant*” used as a main clause– but that when John said it, she was not. In other words, the time of the embedded eventuality cannot be identified exclusively on the basis of the indexical reference and temporal anchoring to the main clause is obligatory. Why is this the case? The answer provided by Giorgi and Pianesi (2000, 2001a), following Higginbotham (1995), is that the anchoring to the main clause is obligatory because the superordinate attitude event is actually represented inside the embedded clause. Giorgi and Pianesi argue that from the syntactic point of view this proposal can be implemented by representing the subject’s –bearer of attitude’s– temporal coordinate in T.

It should be noticed that this restriction does not affect only DAR sentences, but seems to be a property of tenses in embedded contexts. Consider the following two sentences:

(8) John said that Mary was sleeping.

(9) Gianni ha detto che Maria dormiva (IMPF).

In both Italian and English, the sleeping time is perceived as being either past (backwards shifted reading), or simultaneous to the temporal location of the

⁶ Several questions arise in connection with this issue. The first one has to do with the precise meaning of sentences such as (1) in Italian-like languages. In particular, is the speaker asserting the embedded content? And if not, which are the conditions allowing the speaker to felicitously utter (1)? I will not enter in this discussion in this paper, and refer the reader to the relevant literature on the phenomenon. See, among the others, Ogihara (1996), Higginbotham (2001), Abush (1997), Schlenker (2003) and Giorgi and Pianesi (2001a).

superordinate subject.⁷ The Romanian or Russian counterpart of (8) or (9) only give a backward shifted reading. That is, we find again the situation found for sentence (1). In English and Italian both the utterance time and the time of the superordinate event must be taken into account, whereas only the latter matters for Romanian and Russian. Again, what is missing is a language in which the embedded past tense is interpreted as in a matrix clause – that is, as a mere indexical, allowing (8)-(9) to report about a dictum of John locating the sleeping in the subject's future, and in the speaker's past.

Before proceeding further, let me spend a few words on the *de-re* theory of the DAR. For this theory the DAR is just a property of the present tense; the past forms and the future are immune to the requirements posed by present tense forms.

Consider first Abusch' (1997) theory of *inherited temporal relations*. The present tense in her theory is licensed only if the local plus all the inherited temporal relations overlap. In a present-under-past context this is not the case. In her terminology, the present tense is a *de-re* form, hence the present tense is scoped out to an extensional position, leaving a trace. In other words: a present tense cannot be properly interpreted when appearing in the scope of a past verbal form. The scoped-out present tense is interpreted as one would expect –namely, as a present tense with respect to the utterance time. Moreover, under her theory it is required that the trace, which behaves as a free variable, have a reference that is not after the subject's time. She dubs this requirement *the upper limit constraint*. Hence, the internal time wither overlaps or precedes the time of the saying.

Schlenker (2003) theory of tenses is framed within a more general attempt towards a unified theory of all linguistic objects whose semantics counterpart is constituted by variables: pronouns, tenses, and mood. The starting point is that these objects are phenomenologically akin, so that one can speak of 'sequence of person', and 'sequence of mood', besides the more traditional 'sequence of tense'. Hence, one could also speak of Double Access Reading for mood, which complements the DAR for tenses. Another qualifying theme of Schlenker's work is the attempt of showing that the Kaplanian –see Kaplan (1989)– prohibition against (indexical) monsters is empirically and theoretically

⁷. Actually, as discussed at length in Giorgi and Pianesi (1997, 2000), the Italian example admits a backward shifted reading only when the contexts makes available a suitable temporal/eventive entity, as for instance in the following case:

(i) Gianni ha detto che *ieri alle 5* Maria dormiva

Gianni said that yesterday at five Maria was sleeping(IMPF)

unjustified. In Kaplan's terminology, monsters are operators that can shift indexical, that is, operators that, operating on the context, make it possible for an indexical (e.g., *I*, *now*, etc.) to draw its value from the coordinate of a context different from that of the actual speech (or thought) event. In particular, the absence of operators of this kind makes it impossible for an object such as *I* to refer to the agent of the reported speech act or thought. This appears correct, in view of examples such as the following:

(10) John thought that *I* was the culprit

There is no way for this sentence to mean that John thought 'I am the culprit', and this follows if the indexical *I* can only draw its reference from the agent of the actual speech act context, as it appears to be the case. Were monsters available, on the other hand, we should be able to attribute to John the first personal thought 'I am the culprit'. Schlenker argues that the fact that English *I* is an ordinary indexical –necessarily referring to the agent of the current speech act– does not prevent other languages from having objects that exhibit context-shift sensitivity. According to Schlenker's view, there might even be objects that are acceptable only if the relevant context is different from that of the actual speech act. Schlenker suggests that Amharic first person pronoun is such a case, in that it can be shifted in propositional attitude contexts to refer to the agent of the reported thought/speech act. Once these premises are accepted, verbs of propositional attitude can be construed as quantifiers over context, that is, as Kaplanian monsters.

As for the DAR, Schlenker maintains that the English present tense is an ordinary indexical. Hence the only way is to scope it out, as in Abusch, and resort to *de-re*.

These approaches might be taken to have two important shortcomings. The first one is that the present tense must be regarded as a *special* verbal form with respect to the other ones, in that it exhibits the DAR and is *de-re*, whereas the other tenses can be interpreted *in situ*. For instance according to Abusch (1997) in sentence (8) above the embedded past features can be deleted, so that the verbal form is interpreted as simultaneous to the superordinate event.

I'll discuss below with further details the issue concerning the interpretation of the other verbal forms. Let me point out here, however, that the claim according to which the other tenses such as past forms, can be interpreted *in situ*, in English is only true of statives and progressives, and in Italian of imperfect verbal forms. Consider for instance the following examples:⁸

⁸. On the imperfect, see Giorgi and Pianesi (2004b), Ippolito (2004), Delfitto and Bertinetto (2000).

(11) John said that Mary was sleeping.

(12) Gianni ha detto che Maria dormiva(IMPF).

Example (11) features a progressive verbal form. A non-progressive form could not be interpreted in the same way, forcing an interpretation where the embedded event precedes the main one:

(13) John said that Mary slept.

In other words, in this case the past features could not be *deleted*, as Abush proposes for past-under-past sentences. Furthermore, in example (12) the form *dormiva* (was sleeping) is an imperfect of the indicative –namely, a past form with a very peculiar status and distribution. Other past forms would not have the same interpretation:⁹

(14) Gianni ha detto che Maria ha dormito/ dormì
Gianni said that Maria slept(PAST)

Analogously to the English case, example (14) can only mean that the sleeping precedes the saying.

Giorgi and Pianesi' (2000, 2001a) propose that the DAR observed with the present tense is just one aspect of a much more complex phenomenon concerning the syntax and interpretation of indicative complement clauses. They claim that the present tense does not differ with respect to the other verbal forms, and that the properties of the DAR interpretation must be generalized to the whole indicative domain. This perspective has

⁹. In what follows I will consider the Italian present perfect as equivalent to the English simple past. In Italian there is however a simple past – in this case *dormì* (left). The distribution of the present perfect and the simple past in Italian is very different from the English one. In English they are really two different *tenses*, exhibiting different properties and obeying different constraints. In Italian, in many contexts, they seem to be largely equivalent forms –even if this is undoubtedly an oversimplification– and their distribution varies according to the dialectal and regional linguistic background of the speakers. Even if the two forms are not perfectly equivalent –see Giorgi & Pianesi (1997, ch. 3 and references cited there)– here I will abstract away from the differences, given that they do not seem to be relevant to the end of this discussion. In general, I will consider the Italian present perfect as corresponding to the English simple past, and will gloss it as (PAST).

been further elaborated by Giorgi (2008) and constitutes the basis of the analysis I'm going to present here.

The second shortcoming of the *de-re* approach is that there is no hint as to why languages differ. The only possibility for distinguishing Italian and English from Romanian and Russian would be to say that the present tense is *different*. This however sounds quite arbitrary and unjustified: Why should people categorize present tense differently? In the discussion provided here, I will not address the cross-linguistic issue, but will only consider the properties of Italian and I'll refer the reader to the references for further discussion.

2.2. Sequence of Tense (SoT) phenomena in Italian

In this section I present the main data concerning the distribution of the various verbal forms under a past tense and I will illustrate a possible theoretical account in the spirit of Giorgi and Pianesi (2000, 2001a) and Giorgi (2010). Consider the following sentences:

- (15) Gianni ha detto che Maria è partita
John said that Mary left
- (16) Gianni ha detto che Maria partirà
John said that Mary will leave
- (17) Gianni ha detto che Maria sarebbe partita
John said that Mary would leave

In sentence (15) the embedded past is interpreted as locating the eventuality of leaving before the saying. In (16) the embedded future locates the leaving after the utterance time, whereas in (17) the future-in-the-past locates it after the saying, but not necessarily after the utterance time.

The question to be considered at this point is whether the temporal location of the embedded event in (15)-(17) is ruled by the same principles ruling its location in sentences (1) and (2). The answer depends on the theory one develops for the DAR. If one wants to attribute the peculiar effect found in (1)-(2) to the properties of the present

tense as such, then the principles of SoT ruling (15)-(17), where other temporal forms appear, must be different ones.

According to this point of view, it could be claimed that the present tense obeys some specific principles yielding the DAR effects. The past tense, on its turn, obeys a general anchoring principle, to the effect that the anchoring point of the embedded past is not the utterance time –as in *Maria è partita* (Maria left) taken as a main clause– but the time of the main eventuality –i.e., of the saying. As for the embedded future, in the literature, mainly developed in Germanic-speaking areas, it is often regarded as a *modal* form, having a futurity interpretation, and therefore ruled by still different principles with respect to the ones ruling normal tenses. Such a view on the future cannot however be trivially generalized to (most) Romance languages, which, on the contrary, do have a morphological future. Therefore, some *ad hoc* hypothesis must be proposed to the effect that the morphological future of Italian can be considered equivalent to a modal form such as the one found in English –and in all Germanic languages.

The other possibility –the one discussed in Giorgi (2010) and which I adopt here– would be to argue that the effects found with the present tense in (1)-(2) are not due to some principles of grammar at work only with the verbal form. On the contrary, the principles of SoT are the same for all the verbal forms appearing in the complement clauses. The interaction between the morphosyntactic properties of the verb and the rules of grammar determines the temporal location of the embedded event, giving rise to the whole paradigm in (1)-(17). Such a hypothesis seems more appealing than the one proposing a different principle for each tense. Therefore, I pursue this line of reasoning and propose the *Generalized DAR theory*, as proposed in Giorgi and Pianesi (2002, 2001a) to emphasize the fact that no *ad hoc* principle is proposed for a specific verbal form.

The starting consideration is that the interpretation of the sentence in (1) –*Gianni said that Maria is pregnant*– in all DAR languages, as I discussed above, entails a double evaluation of the embedded event. It has to be located once with respect to the temporal location of the subject of the main clause –*Gianni*– and once with respect to the temporal location of the speaker –i.e. the utterance event. In both cases it counts as a *present*, yielding therefore a simultaneous interpretation with respect to both events.

The obvious move at this point would be to check whether this generalization can be maintained also with an embedded past and an embedded future. In other words: what interpretation would one obtain considering an embedded past as such both with respect to the main event of saying and with respect to the utterance event? And, analogously,

what interpretation would one obtain if an embedded future is considered as such with respect to both events?

Let me consider the past forms first. As I illustrated above, one would get a different grammatical status, both with respect to Italian and w.r.t. English, depending on the specific past form used. Here I reproduce the relevant examples:

(18) Gianni ha detto che Maria ha dormito
Gianni said that Maria slept(PAST)

(19) Gianni ha detto che Maria dormiva
Gianni said that Maria was sleeping(IMPF)

As pointed out above, in example (18) the embedded event expressed by means of *ha dormito*, is interpreted as a past w.r.t. the saying *and* as a past w.r.t. the utterance time. The embedded imperfect, instead, is interpreted as simultaneous to the saying event. Note however, that the imperfect, is not a straightforward past form, in that it can have several non-past interpretation, which are unavailable with the other forms of past. For instance it can be used as a *preludique* form: ¹⁰

(20) Facciamo che io ero il re e tu eri la regina
Let's do that I *was*(IMPF) the king and you *were*(IMPF) the queen

The embedded verbs in (20) do not convey a past meaning, but favor a *planning* interpretation. The eventuality they are referring to, lies in the future, as a planned event, and not in the past.

A non-imperfect past form is not available in this context:

(21) *Facciamo che io sono stato il re e tu sei stata la regina
Let's do that I *was*(PAST) the king and you *were*(PAST) the queen

Furthermore, the imperfect can be used in future conditionals:¹¹

¹⁰. Cf. Vet, (1985). For further discussion on non-temporal usages of the imperfect, see Bertinetto (1986), Giorgi and Pianesi (1997, 2001b), Ippolito (2004).

¹¹. For an analysis of the imperfect in *if*-clauses, cf. Ippolito (2004).

- (22) Se partivi domani, forse trovavi bel tempo
 If you *leave* (IMPF) tomorrow, maybe you *find*(IMPF) good weather
 ‘If you had left tomorrow, maybe you had found good weather’

Again a non-imperfect form would not be available in this case:

- (23) *Se sei partito domani, forse hai trovato bel tempo
 If you left tomorrow, maybe you found good weather

Going back to sentence (19), it seems possible to conclude for the time being that the imperfect is not a *real* past form –exhibiting a wide range of possible temporal interpretations, most notably future ones– whereas the past is. Under this perspective, therefore, the behavior of an embedded past is exactly analogous to that of the embedded present I illustrated above: an embedded past is interpreted as past both with respect to the superordinate event and w.r.t. the utterance time.

Consider now an embedded future. I repeat here the examples in (16)- (17) given above:

- (24) Gianni ha detto che Maria partirà
 John said that Mary will leave
- (25) Gianni ha detto che Maria sarebbe partita
 John said that Mary would leave

The form *partirà* (will leave) in Italian is a real morphological future. Etymologically, it is derived from the Latin infinitive form of the verb plus the infinitive of the auxiliary *have*. For instance, the future verbal form *amerò* (I will love) is derived by incorporating Latin auxiliary *habeo* (I have) in the infinitive *amare* (to love). This way of deriving the future –namely, by incorporating an auxiliary into the verb– is the usual way of deriving verbal forms in Latin and later in Romance languages. Hence, it seems legitimate to hypothesize that this form is on a par with the past and is not ‘a present tense in disguise’.

Analogously to what I proposed above for the present and the past, the embedded event in (24) must be located in the future both with respect the main event of saying and w.r.t. the utterance event. This is not the case for the *would-future* in (25), which locates the event after the superordinate event, but not necessarily after the utterance event.

Analogously to the imperfect, the verbal form used in the future-in-the-past –the perfect conditional– does not have a unique temporal value, being used in modal contexts, most typically in *if*-clauses:

- (26) *Maria sarebbe partita* puntuale, se si fosse svegliata in tempo
 Maria would have left punctually, if she had waken up on time

Note also that it is not possible to use a future with the meaning of a future-in-the-past. In other words, in (24) there is no way in which the embedded leaving event can be interpreted as future with respect to the saying, but as past with respect to the speaker's temporal location.

Hence, from this brief analysis it is possible to conclude that the following generalization holds:

- (27) Present, past and future indicative verbal forms in embedded contexts are temporally located twice: once with respect to the superordinate event and once with respect to the utterance time.

The generalization in (27) however, is exactly what was identified above as the Double Access Reading. Hence, it can be concluded that in Italian embedded indicative forms obligatorily have the DAR – with a special *proviso* for the imperfect, traditionally classified as an indicative verbal form.

2.3. A proposal

As I briefly discussed in section 2.1, following Higginbotham (1995) and Giorgi and Pianesi (2000, 2001a), I assume that the subject's –bearer of attitude's– temporal coordinate is represented in the T projection of the embedded clause. The existence of such a relation has the effect, on the interpretive side, of temporally locating the embedded event with respect to the superordinate one.

Furthermore, following Giorgi (2010), I propose that the DAR arises as the interpretive counterpart of the syntactic properties of the Complementizer-layer. The highest position in the C-layer is endowed with speaker-related features. In indicative clauses the embedded verb must necessarily relate to this position, much in the spirit of Pesetsky and Torrego (2004, 2006). As a consequence, an embedded event ends up

being evaluated with respect to the speaker's temporal location. These two syntactic relations therefore, are responsible for the DAR phenomena.

In the next section I'll develop this idea, by comparing the properties of embedded clauses with a subjunctive verbal forms with the indicative clauses I just illustrated. The differences between the interpretive properties of indicative and subjunctive clauses – roughly speaking, DAR vs. non-DAR interpretation– will be shown to correlate with syntactic differences in the C-layer, providing therefore an argument in favor of the proposal. In particular, I will propose that when there is no DAR interpretation, the highest position in the C-layer is not realized.

3. Subjunctive complement clauses

3.1. Sequence of Tense with the subjunctive

In Italian –and in other Romance languages as well– some verbs select in the subordinate clause a special verbal form, called *subjunctive*. The subjunctive cannot appear as the verbal form of a main assertion. If used in non-subordinate clauses, it always conveys a *nodal* meaning. Consider for instance the following example:

- (28) Che il diavolo ti porti!
That the devil take(SUBJ PRES) you!

In this case for instance, the sentence is an *optative* one and could never be interpreted as an assertion.

In complement contexts, the choice between an embedded indicative and an embedded subjunctive is not free, but is due to the properties of the superordinate verb. In Italian for instance typically the subjunctive appears in subordinate contexts, under verbs of believing/ thinking/ wishing etc.¹²

Consider the following examples:

¹². See Giorgi & Pianesi (1997, ch.4) for an analysis of the contexts admitting an embedded subjunctive in Italian and for a cross-linguistic analysis across Romance and Germanic. The issue however has been widely addressed in the literature. For a most recent analysis, see Quer (to appear) and papers published there.

- (29) Gianni crede che Maria mangi un panino
Gianni believes(PRES) that Maria eats(pres SUBJ) a sandwich
- (30) Gianni credeva che Maria mangiasse un panino
Gianni believed(PAST) that Maria ate(past SUBJ) a sandwich¹³

In (29) a present subjunctive is embedded under a main present tense –*crede* (believes). In (30) a past subjunctive is embedded under a past main verb –*credeva* (believed). Note that in (30) the relation between the main event and the embedded one is not a precedence relation, as in the cases with the (non-imperfect) indicative illustrated above, but of simultaneity, similarly to the cases with the imperfect I briefly illustrated above. Moreover, the clause embedded under a subjunctive is compatible with any possible location with respect to the utterance time, as shown by the following example:

- (31) Gianni credeva che Maria partisse ieri/ domani
Gianni believed that Maria left (past subj) yesterday/ tomorrow

In (31) the temporal adverbial appearing in the embedded clause might locate the event in the future –tomorrow– or in the past –yesterday– but the verbal form does not vary. It seems therefore that the past morpheme appearing with the subjunctive is a sort of “temporal agreement” morpheme. This hypothesis is supported also by the following examples:

- (32) *Gianni credeva che Maria mangi un panino
Gianni believed(PAST) that Maria eats(PRES SUBJ) a sandwich
- (33) ??Gianni crede che Maria mangiasse un panino
Gianni believes(PRES) that Maria ate(PAST SUBJ) a sandwich

¹³. I'll not discuss here why the main verbal form –glossed with a past in English– is an indicative imperfect and not a past such *ho creduto* (lit: I have believed); this is due to aspectual reasons that lie outside the scope of this work. In Italian, in general, the present perfect/simple past with stative predicates are infelicitous options. See Giorgi and Pianesi (1997, 2001a) for an analysis of the aspectual properties of these forms.

In these cases the embedded clause contains a subjunctive in the non-agreeing form – namely, a present under a main past tense, and a past under a main present tense, respectively. Both sentences are bad, with a special proviso for example (33). The marginal status of the embedded clause in (33) can be explained by the fact that this sentence can be, at least partially, rescued if inserted in the right context, for instance by inserting a temporal adverb: ¹⁴

- (34) Il testimone crede che ieri alle 5 l'accusato mangiasse/stesse mangiando un panino
The witness believes that yesterday at five the accused ate(PAST SUBJ) a sandwich

In this case, the temporal agreement relation is not instantiated with the superordinate verb, but with the past temporal adverb. Sentence (33) could be rescued, in an analogous way, if a past temporal topic is provided by the contexts, i.e., present in the previous discourse.

Note that this distribution of temporal forms is precisely what goes under the name of Sequence of Tense in traditional grammars. This kind of temporal agreement in fact is the basic rule in the Latin language concerning the distribution of non-infinitival verbal forms in embedded clauses.

Italian however allows the expression of anteriority in embedded clauses, with the subjunctive as well. In order to express it, a compound form must be used:

- (35) Gianni crede che Maria abbia mangiato un panino
Gianni believes that Maria has(PRES SUBJ) eaten a sandwich
- (36) Gianni credeva che Maria avesse mangiato un panino
Gianni believed that Maria had(PAST SUBJ) eaten a sandwich

In these cases, the past interpretation of the embedded event with respect to the main one is obtained derivatively, thanks to the presence of the resultant state, expressed by means of the past participle. This is so because the state, 'resultant' from a necessarily *anterior* event, must hold at the time identified by the computation of the temporal

¹⁴. For a discussion see Giorgi (2008) and Costantini (2008).

relations. Consequently, in this case it must hold at the time of the superordinate event. Hence, the eating ends up being past with respect to the believing.

Finally, in Italian there is no subjunctive future. The future-in-the-past –namely, the same form used with the verbs of saying selecting the indicative– expresses a future relation with respect to the superordinate clause:

- (37) Gianni credeva che Maria sarebbe partita
Gianni believed that Maria would leave

Interestingly, in the case of a main present tense, the embedded form for expressing futurity is preferentially a present subjunctive to which a future-like interpretation can be assigned, in a way analogous to the future interpretation of the present of the indicative. This interpretation is often induced by a temporal adverb, as in the following case:

- (38) Gianni crede che Maria parta domani
Gianni believes Maria leaves(PRES SUBJ) tomorrow

Both in the case of the embedded imperfect and in the case of the subjunctive there is no DAR.

This would be trivially true in a perspective that considers the DAR a phenomenon relevant only for a present tense embedded under a past. Even in the perspective considered here, however, the absence of DAR effects is expected: the subjunctive is considered functionally equivalent to an inflected infinitival, with no temporal interpretation of its own, given that tense morphology is a mere agreement phenomenon.

3.1.1. The analysis of *ipotizzare* (to hypothesize)

I proposed above the generalization that in subjunctive contexts there is no DAR, and that it could not be otherwise given that tenses seem only to satisfy an agreement condition. The DAR can only arise if the main and the embedded event have different locations in time, even if they might at least partially, overlap. There are however some exceptions. Consider for instance the following example:

- (39) Gianni ha ipotizzato che Maria fosse incinta
Gianni hypothesized that Maria is (PRES SUBJ) pregnant

In sentence (39), a past subjunctive is embedded under a past indicative, as illustrated in the previous section. However, independence of this predicate the following sentence is also possible:

- (40) Gianni ha ipotizzato che Maria sia incinta
Gianni hypothesized that Maria was(PAST SUBJ) pregnant.

The observation relevant for the present discussion is that in (40) the temporal interpretation of the embedded verbal form is analogous to the one illustrated above for the indicative clauses, in that the DAR is enforced. The following example is therefore odd, for the same reasons I gave above for example (3):¹⁵

- (41) #Due anni fa, Gianni ha ipotizzato che Maria sia incinta
Two years ago, Gianni hypothesized that Maria is(PRES SUBJ) pregnant

Sentence (40) (obligatorily) means that Maria's pregnancy holds at the time of the hypothesizing and at the time of the utterance. This piece of evidence therefore parallels the phenomena discussed in section 2.1.1 above.

On the basis of this piece of evidence, it can be concluded that in most cases subjunctive verbal forms do not enter in the establishing of temporal relations. They seem to be transparent, being only an instantiation of temporal agreement with a superordinate verbal form. At a closer look, however, the subjunctive morphology turns out to be in some cases endowed with temporal content, undergoing the same SOT rules which govern the indicative.

¹⁵. Consider also that the following sentence:

- (i) *Gianni credeva che Maria sia incinta
Gianni believed that Maria is(PRES SUBJ) pregnant

Even if ungrammatical, is interpreted. Interestingly, it has the DAR interpretation. This fact shows that the DAR is a property of a general syntactic configuration, given that in this case it seems independent both from the nature of the superordinate predicate and from the nature of the embedded verb – in this case a subjunctive, typically *not* exhibiting the DAR.

The question at this point is for what reason the DAR is obligatory in this structure and why a present subjunctive under a past is allowed in the case of *ipotizzare* (hypothesize), in example (40), but not with *credere* (believe) in example (32).

This question can be immediately answered in a somewhat informal way. The verb *hypothesize* in Italian can be used in two different situations. The speaker can be talking about Gianni's *mental* processes –in which case, the sentence concerns a particular thought that appeared in Gianni's mind in a hypothetical form– or she can be describing Gianni's *behavior*. If so, the speaker is reporting a *communication* –i.e., a speech act– made by Gianni in a hypothetical way.¹⁶

In sentence (40) only the latter possibility is available, whereas in sentence (39) both are possible. The verbs of communication in Italian in general select the indicative and exhibit the DAR, whereas mental states (mostly) select the subjunctive. Hence, *ipotizzare* (hypothesize) has an intermediate status: It selects the subjunctive, like mental state predicates, but when endorsed with a communicative meaning it permits a non-agreeing subjunctive and requires the DAR.¹⁷

In what follows, I'll address the following question: how can the *ipotizzare* examples be explained? And, more generally, what triggers indicative/ subjunctive morphology and DAR/ non-DAR interpretation? The answers to these questions will prove to be relevant not only to achieve a better characterization of the subjunctive in itself, but also to clarify what exactly determines the indicative/ subjunctive distinction.

¹⁶. J. Higginbotham pointed out to me that the verb *guess* in English seems to exhibit the same double meaning.

¹⁷. The fact that a verb such as *credere* (believe) selects the subjunctive is not a universal property, given that in many languages –as French and Spanish, among the others– verbs of *believing* select the indicative as well. Portuguese, on the contrary, is like Italian. However, the distinction between verb referring to speech act and those referring to mental states is relevant in Italian. Giorgi and Pianesi (1997) hypothesized a semantic parameter to account for this fact: Some languages, as Italian, are sensitive to the speech act/ mental state distinction, whereas other ones might be sensitive to peculiar modal properties of the contexts. See also Quer (to appear).

3.2. Complementizer Deletion

In section 2.3 I sketched the proposal that the DAR reading arises because the verb must enter a relation with the highest position in the C-layer. This position is endowed with the speaker's temporal (and spatial) coordinates. In this section I'll provide arguments in favor of this hypothesis.

In standard Italian the complementizer introducing indicative clauses cannot be deleted, contrasting with the complementizer introducing a clause containing a subjunctive verbal form:¹⁸

(42) Gianni ha detto *(che) è partita
Gianni said that (she) left

(43) Gianni credeva (che) partisse
Gianni believed (that) (she) left

Before analyzing these cases, let me point out that the contrast in (42) and (43) immediately shows that there is a difference between Italian and English, as far as the omission of the complementizer is concerned. In English the generalization is that so-called bridge verbs admit *that* deletion, including therefore also verbs of *saying*. Therefore, the translation of a sentence without the complementizer such as (43) would be perfectly fine in English, whereas it is ungrammatical in (standard) Italian.

Consider now what happens with the *ipotizzare* (hypothesize) examples illustrated above. The distribution of CD is the following:

(44) Gianni ha ipotizzato (che) fosse incinta
Gianni hypothesized (that) (she) was(PAST SUBJ) pregnant

(45) Gianni ha ipotizzato *(che) sia incinta
Gianni hypothesized (that) she is(PRES SUBJ) pregnant

The main verb is a past form in both examples (44) and (45). In (44), where the embedded verbal form is a past subjunctive –i.e., where the subjunctive form appears

¹⁸. A special proviso holds in *Fiorentino*, where the deletion seems to be possible even in the indicative contexts appearing under *dire* (say), at least in certain cases. I leave the issue open for further research.

according to the rules of the Latin-like *consecutio*– CD is optional, as in the other subjunctive cases discussed above. In the other case, where the embedded verbal form is a present subjunctive –i.e., the sequence of tenses is anomalous with respect to the normal subjunctive distribution– CD is impossible. Recall that sentence (45) is the one where the DAR is enforced – so that the sentence means that the pregnancy of Maria holds both at the time of the hypothesis and at the utterance time.

One might wonder whether this can be due to the presence of a present tense vs. a past *per se*. The following sentence, however, is possible with CD, as expected, showing that the present subjunctive in itself does not block CD:

- (46) Gianni ipotizza (che) sia incinta
Gianni hypothesizes (that) she is (PRES SUBJ) pregnant

From these examples it is possible to draw a further generalization. There is a relation between the DAR and CD: the DAR is enforced only when CD is not available. In other words: no context allows both the DAR and CD.

Notice that the other direction of the generalization does not hold: CD can be unavailable, for reasons that have nothing to do with the DAR. There are contexts allowing neither DAR nor CD, as for instance the contexts selected by factive verbs:

- (47) Gianni rimpiange *(che) sia partita
Gianni regrets *(that) she has (PRES SUBJ) left
- (48) Gianni rimpiangeva *(che) fosse partita
Gianni regretted *(that) she had (PAST SUBJ) left
- (49) *Gianni rimpiangeva *(che) sia partita
Gianni regretted (that) she has(PRES SUBJ) left
- (50) Gianni rimpiange *(che) fosse partita
Gianni regrets *(that) she had (PAST SUBJ) left

CD in this case is never allowed, even if the distribution of the subjunctive in the embedded clause is the canonical one: Past under past and present under present. The reason for the impossibility of CD –analyzed in Giorgi and Pianesi (2004a)– is not directly related to SoT properties, but to the characteristics specific of factive contexts. As shown in fact be the ungrammaticality of sentences (49) and (50), the temporal

interpretation is the one expected under normal conditions. In particular, note the DAR configuration given in (49) is unavailable; hence, the relation between DAR and CD is just one-way. In any case, as discussed below, this is sufficient for permitting the establishing of a correlation between the two.

At this point the following question must be addressed: What makes CD possible, or conversely what disallows the DAR? The superordinate predicate certainly has a role, because it is precisely the main verb, which selects an indicative –never admitting CD and always requiring the DAR– or a subjunctive –‘in many cases’ permitting CD and not requiring the DAR. Hence, one might propose that the DAR –and consequently absence of CD– is a property of verbs such as *dire*, or the speech act *ipotizzare*, whereas verbs like *credere* never permits it.

This hypothesis can be tested. Note that for some Italian speakers –even if not for the author of this article– *credere* (believe) can either select for a subjunctive or for an *imperfect* indicative verbal form, without changing its semantic interpretation. Only the subjunctive option however is compatible with CD. Consider for instance the following example:¹⁹

- (51) (*)Gianni credeva *(che) aveva telefonato Maria
 Gianni believed that had(IND IMP) called Maria
 ‘Gianni believes that Maria called’

even for the speakers who accept the imperfect, CD is impossible, on a par with the verbs of *saying* such as *dire* (say), as discussed above.

Given this piece of evidence, it follows that CD can neither be regarded exclusively as due to the main verb, nor to the subjunctive in itself, but must be investigated as a property stemming from the complex interaction between the two.

Giorgi and Pianesi (2004a) pointed out that in many languages, including some Italian dialects such as Salentinian, the complementizer introducing the indicative and the one introducing the subjunctive have different morphological forms.²⁰

¹⁹. Crucially the non-imperfect of the indicative is unacceptable for all speakers:

- (i) *Gianni credeva che Maria ha telefonato
 Gianni believed that Maria has(IND) called

²⁰. On complementizer deletion in Italian see also Scorretti (1994) and Poletto (2000, 2001). On Salentinian, see Calabrese (1984).

Moreover, in many languages, such as for instance Greek and Romanian, the particle introducing the subjunctive seems to share both the properties of a complementizer and the properties of a morphological specification of mood.

According to Giorgi and Pianesi (2004a) and Giorgi (2010), the particle introducing the subjunctive in Italian is, on one hand, part of the subjunctive morphology. On the other, it is selected by the main verb, hence it looks like a complementizer, even if it actually occupies a position lower than the ‘real’ indicative complementizer.²¹

In the following pages, I will keep to this hypothesis and develop a proposal to account for the distribution of embedded verbal forms in Italian.

4. The representation of the speaker’s coordinate in the C-layer

4.1. In indicative clauses

As illustrated in section 3.2, the indicative complementizer can never be deleted and always enforces the DAR. Therefore, it cannot be taken to be part of the morphology of the embedded verb –as I proposed elsewhere on the contrary for the subjunctive complementizer– but must be considered a lexical item endowed with its own properties. The obvious question is then the following: why is there a complementizer at all? What’s its function?

Note that the existence of complementizer deletion in many languages, even with verbs of saying, prevent us from proposing the trivial *functional* explanation –namely, that the role of the complementizer is that of signaling the beginning of an embedded clause. Many embedded clauses in fact are allowed to have no complementizer at all. Therefore, we must look elsewhere for an explanation.

Giorgi (2010) proposes that the function of the complementizer layer is to connect the clause to the context, hence it is the syntactic position where the syntax-contexts interface information is encoded.

Note that this consideration in a way is already implicit in Rizzi’s work (1997, 2001, 2002), given that in his articles he shows that the complementizer layer is the *locus*

²¹. By ‘selection’ I refer to the phenomenon according to which certain verbs require the indicative and other the subjunctive. The issue has been widely analyzed in the literature on the topic. I refer the reader to Quer (to appear) and references cited there and to Binnick’s bibliography (see fn.1).

where the Focus and Topic information is realized. Topic and Focus are exactly the sort of information one expects to find in a syntax-discourse interface.

Hence, the hypothesis of this article is that the speaker's temporal and spatial coordinates are always represented in the highest, leftmost, position in the Complementizer-layer. In the subjunctive clauses however, the speaker's coordinates might be present –as in the case of *ipotizzare* illustrated above– but in general they are not there. The distinction between the indicative and the subjunctive is exactly the one regarding the presence or absence of the speaker's coordinates.²²

The first important distinction among verbal forms is whether they express a *relational* tense, or not. Relational tenses are two-place predicates of the form *e R e'*, where R – relation– stands either for temporal *overlap* or for temporal *precedence*. In Giorgi (2010), it is argued that the present, the future and the past tenses of the indicative are relational verbal forms. The imperfect and the future-in-the-past are not, as well as the subjunctive. The relational forms must identify their temporal arguments, whereas the non-relational ones must be licensed by the morphosyntactic context. This difference is of primary importance in describing and accounting for the Italian verbal system and in the next pages I will illustrate some of the predictions following from such a bipartition. Let's go back to the indicative/subjunctive distinction: The indicative can be characterized as a relational tense, instantiating an overlapping or preceding relation between two events. Consider for instance a past-under-past indicative clause:²³

(52) Gianni ha detto che Maria ha telefonato
Gianni said(PAST) that Maria has(PAST IND) called

(53) [.....[v detto [C-speaker ... che ...[T-subject... T ... [... ha telefonato_{sp, sb} ...]]]]]

²². In this article I actually only consider the *temporal* speaker's coordinate, putting aside the *spatial* one. For the relevance of the spatial coordinate with respect to SoT phenomena, see however Ritter and Wiltchko (2008). See also the brief discussion in Giorgi (2008, ch.5).

²³. I put aside the questions arising with the indicative imperfect, as in the following sentence:

(i) Gianni ha detto che Maria dormiva
Gianni said that Maria slept(IMP IND)

This question has been considered in Giorgi and Pianesi (2004b). I'll not take it into account here, given that it is not crucial for the present analysis.

The embedded past verbal form, *called*, is a relational tense: $e R e'$. In this case, the relation in question is *precedence*. The event e is constituted by the calling event itself. The verbal form bears a pair of features: *sb* (subject) and *sp* (speaker). In Italian, the verb is (I-)merged with T and the feature *sb* is (E-)merged in T at the next step. The feature *sb* must agree with the feature *sb* of the bearer-of-attitude's –i.e., with the main subject's temporal coordinate. As I suggested above, in fact, the T-layer of indicative clauses contains the temporal (and spatial) coordinates of the attitude bearer in its left-most position. Hence, the second argument of the predicate R, e' , is identified with the superordinate *saying* event. The embedded event is therefore interpreted as past with respect to the temporal location of *Gianni*.²⁴

Then, the complementizer is (E-)merged and T-to-C movement takes place. In the framework developed by Chomsky (2002, 2005), we can say that T is copied in C, but pronounced in the lower position. The feature *sp* can be considered as a *pointer* to the context, interpreted at the interface as the speaker's temporal coordinate –i.e., the utterance time *now*. Its presence gives rise in this case to the past interpretation of the embedded event with respect to the temporal location of the speaker, i.e. past with respect to the utterance event.

Concluding, the embedded event ends up being doubly evaluated: once with respect to the subject's temporal coordinate, and once with respect to the speaker's coordinate. In this case the interpretive process gives as a final result the *calling* event as past with respect to the *saying*, and past with respect to the utterance.²⁵

Exactly the same reasoning can be applied in the case of an embedded present tense or of an embedded future. Consider for instance an embedded future:

(54) Gianni ha detto che Maria telefonerà
Gianni said(PAST) that Maria will call (FUT IND)

(55) [.....[v detto [C-sp ... che... [T-sb ... T ... [...telefonerà_{sp, sb} ...]]]]]

²⁴. On the reason why the notion *bearer-of-attitude* is more appropriate than the notion of superordinate *subject*, see Giorgi and Pianesi (2001) and Giorgi (2006, 2007). See also Costantini (2005).

²⁵. Which in sense is trivial. The purpose of the example however is to show how the system works to derive all the relevant cases.

The embedded future, *telefonerà* (will call), instantiates the relation $e' R e$, which is the reverse of the one attributed to the past form. The event e is calling event, bearing the features: *sp* and *sb*. The feature *sb* agrees with the feature *sb* of the bearer-of-attitude's – i.e., with the main subject's – temporal coordinate, with the consequence that the embedded event is interpreted as future with respect to the temporal location of *Gianni*. Then, T-to-C movement takes place, and T is copied in C. The feature *sp* in T gives rise to the future interpretation of the embedded event with respect to the temporal location of the speaker, i.e. future with respect to the utterance time.

4.2. In subjunctive clauses

The subjunctive, as discussed in the previous sections, is not a relational tense, in that it only instantiates a temporal agreement relation between the embedded and the superordinate form. The lexical item *che* introducing subjunctive clauses does not encode the speaker's coordinate. For this reason, it can be dispensed with, without losing crucial syntactic and semantic information. The temporal interpretation of the embedded event is therefore simultaneous with respect to the main one

As discussed above in section 3.2, however, even if *most* DAR contexts are realized by means of an indicative verbal form, *some* subjunctive embedded clauses do indeed exhibit the DAR, as the *ipotizzare* cases. The syntax of subjunctive clauses with DAR effects is indeed parallel to the one of embedded indicative clauses. More precisely, in these cases CD turns out to be impossible, as shown in (39), reproduced here for simplicity:

- (56) Gianni ha ipotizzato *(che) sia incinta
 Gianni hypothesized (that) she is(PRES SUBJ) pregnant

Hence, I propose that the syntax of the complementizer in this case is identical to that of an indicative clause. The differences between an indicative, for instance the one under a saying verb discussed above, and a subjunctive under *ipotizzare* lies in the fact that the subjunctive is still non-relational and can only be interpreted as simultaneous with the matrix predicate. Hence no past or future interpretation is possible – a derived past interpretation is available only with a compound form. The DAR arises from the necessity of evaluating the embedded event with respect to the speaker's coordinates, which are realized in the left-most position in the C-layer.

The hypothesis discussed by Giorgi and Pianesi (1997, 2004a), which I adopt here, is the following:

(57) [.....[_V hypothesized [_{C-sp} *che* [_{MOOD} *sia*_{pres} ...]]]]

The projection MOOD is the one instantiated by a subjunctive form. The complementizer *che*, projecting the left-most position in C, bears the feature *sp*, which points to the speaker's temporal coordinate. As a consequence, the embedded event must be interpreted with respect to it. Being tense-less it is interpreted as simultaneous, giving rise to the interpretation according to which the pregnancy overlaps with the time of the utterance. Given the necessity of tense agreement between the embedded verbal form –a subjunctive– and the main one, the embedded pregnancy is interpreted as being simultaneous to the main event as well. As a consequence, in these cases the DAR arises.

For completeness, consider the case of an intervening past topic.

(58) Il testimone crede che ieri alle 5 l'imputato fosse/*sia a casa

The witness believes that yesterday at five the defendant was(PAST SUBJ)/
*is(PRES SUBJ) at home

In this example the main verb appears in the present tense, whereas the embedded one carries the past morphology. In this case a temporal topic is obligatory and can either be provided overtly, or by the context. It can then license the temporal morphology of the embedded verb in a way analogous to the cases seen above:

(59) [.....[_V crede [_{MOOD} *che* [_{TOP} *ieri alle 5* [_T ... *fosse*_{past} ...]]]]

Ieri alle 5 (yesterday at five) is interpreted as a past temporal reference –by virtue of the meaning of *ieri* (yesterday)– and therefore licenses the past feature on the verb. The temporal morphology of the subjunctive therefore is licensed by means of temporal agreement not with the main verb, but with the intervening temporal topic. The usual simultaneous interpretation is provided, so that the event is located *yesterday at five*. Therefore, the past-ness interpretation is a derivative one, being due to the presence of the temporal adverbial. Recall finally that the speaker's coordinate in this case is not represented in C, because *credere* (believe) is not a communication verb, i.e., no C-

speaker appears. Hence, according to the hypothesis illustrated above, it selects a non-DAR subjunctive.

4.3. The imperfect and the future-in-the-past

As I briefly suggested above in section 2.2, the imperfect and the future-in-the-past are not relational verbal forms. The interesting fact is that they both appear in indicative contexts, hence, in contexts where in Italian normally the DAR is found. Let me consider the imperfect first.

When embedded, the imperfect is simultaneous with the superordinate event:

- (60) Gianni mi ha detto che Maria mangiava un panino
Gianni told me that Maria was eating(IMPF) a sandwich

If a temporal topic is inserted, the imperfect event is then understood as simultaneous with it:

- (61) Gianni mi ha detto che ieri alle 5 Maria mangiava un panino
Gianni told me that yesterday at five Maria was eating(IMPF) a sandwich

In this case the event of eating might precede the saying and takes place exactly *yesterday at five*. Note however that if a temporal topic is not provided, either overtly in the sentence, or by the context, in Italian it is impossible to understand the eating as preceding the saying.²⁶

Consider also that CD is impossible with the imperfect, showing that this verbal form actually patterns with the indicative and not with the subjunctive:

- (62) Gianni mi ha detto *(che) mangiava un panino
Gianni told me (that) she was eating(IMPF) a sandwich
- (63) Gianni credeva (che) mangiasse un panino
Gianni believed (that) she was eating(PAST SUBJ) a sandwich

²⁶. In this the Italian imperfect differs from English, in that the past progressive *was eating*, even without any expressed temporal adverb, at least for some speakers, can refer to an event preceding the saying.

Even if it is introduced by the left-most Complementizer, endowed with the speaker's features, no DAR could ever arise, exactly because it is a non-relational verbal form, hence licensed under purely syntactic conditions. In Giorgi (2010) I propose to identify the imperfect as an *anti-speaker* verbal form –i.e., a form which cannot take its reference directly from the speaker's temporal coordinate. This hypothesis explains why in main contexts the imperfect is an *anaphoric* verbal form, always requiring a temporal topic:

- (64) #Gianni mangiava un panino
Gianni was eating(IMPF) a sandwich
- (65) Ieri alle 5 Gianni mangiava un panino
Yesterday at five, Gianni was eating (IMPF) a sandwich

The absence of the temporal topic is not compatible with an imperfect in an out-of-the-blue sentence –i.e., a sentence with no previous background. This property follows from the hypothesis I suggested above: in main clauses the event must be anchored to the utterance event, but this would imply making reference to the speaker's temporal coordinate. The intervention of the temporal topic rescues the sentence, permitting a mediation between the *anti-speaker* property of the imperfect and the anchoring requirements.

The future-in-the-past in Italian is realized as the perfect conditional –i.e., the auxiliary bearing conditional mood morphology, plus the past participle of the verb. It is available both in contexts selecting the indicative and in contexts selecting the subjunctive. Consider for instance the following cases:

- (66) Gianni ha detto che Maria avrebbe mangiato un panino
Gianni said that Maria would eat a sandwich
- (67) Gianni credeva che Maria avrebbe mangiato un panino
Gianni believed that Maria would eat a sandwich

Recall that *dire* (say) selects an indicative, whereas *credere* (believe) selects a subjunctive. Interestingly, CD is acceptable in subjunctive contexts, and much less in indicative ones:

(68) ?*Gianni ha detto avrebbe mangiato un panino

Gianni said would eat a sandwich

(69) Gianni credeva avrebbe mangiato un panino

Gianni believed would eat a sandwich

The fact that CD is compatible with the future-in-the-past is a further argument in favor of its being non-relational: the presence or absence of the speaker's temporal location does not affect it, provided that it is syntactically licensed, because it must not identify the arguments of its two-place predicate.²⁷

5. Dependencies from a main future

In this section I will briefly consider some evidence which has always been quite a puzzle for the study of SoT, namely, the dependencies from a future temporal form. The interpretation of the verbal forms in the clauses embedded under a future does not follow the pattern illustrated above. In these contexts in fact, the coordinate of the speaker seems not to be relevant for the interpretation, in that the clauses complement to a future verbal form do not exhibit the DAR.

Compare for instance the interpretation of a present tense when embedded under a past verbal form –as seen so far– and under a future one:

(70) Gianni ha detto che c'è poco zucchero nel caffè

Gianni said(PAST) that there is(PRES IND) too little sugar in the coffee

(71) Domani, quando gli porterai il caffè, Gianni dirà che c'è poco zucchero

Tomorrow, when you will take him the coffee, Gianni will say(FUT) that there is(PRES IND) too little sugar

The interpretation of (70) is a DAR one. In uttering the sentence the speaker means that there is a single eventuality –*to be not enough sugar in the coffee*– holding both when Gianni said it and *now*. Recall furthermore that the DAR is obligatory. The DAR

²⁷ I will not consider here how come that in Italian the future-in-the-past is expressed precisely by means of the perfect conditional, since it would lead us far away from the main topic of discussion. See Giorgi (2008).

interpretation is however by no means the most natural one for (71). For this sentence to be felicitous there is no need for the sugar to be *already* in the coffee, when the speaker utters the sentence. According to the most natural interpretation, on the contrary, the embedded state does not hold at utterance time, but only at the time of the saying. Consequently, there is no DAR, contrasting with (70). Consider now an embedded past verbal form:

- (72) (Domani, quando gli porterai il caffè,) Gianni dirà che ci hai messo poco zucchero
 (Tomorrow, when you will take him the coffee,) Gianni will say that you put(PRES PERF) in it too little sugar.

Again in this case as well, the most obvious interpretation is that the sugar is *not* in the coffee at the time of the utterance, but that it will be by the time the coffee will be given to Gianni. I.e., the embedded event is interpreted as a past only with respect to Gianni's saying, but not with respect to the utterance time. In this case as well, therefore, there is no DAR interpretation.

For completeness, consider also an example with an embedded future:

- (73) Gianni dirà che Maria telefonerà presto
 Gianni will say(FUT) that Maria will(FUT) call soon

In this case, the calling by Maria is located in the future with respect to Gianni's saying, hence, after the utterance event. Note that, as expected, it is not possible to locate the embedded event only with respect to the utterance time –i.e., in between the utterance event and the main event of saying, as if it were a future with respect to the speaker's temporal location.

Concluding, in the context created by a future –differently from those created by a past– the embedded eventuality has to be located only with respect to the main event and not with respect to the utterance event. In other words, apparently, in these cases there is no DAR.

Note that as far as Complementizer Deletion is concerned, the future-depending contexts pattern with indicative contexts and not with subjunctive ones:

- (74) Gianni credeva (che) tu fossi partito ieri
 Gianni believed (that) you had(SUBJ) left yesterday

(75) Gianni ha detto *(che) tu sei partito ieri
Gianni said (that) you left yesterday

(76) Gianni dirà *(che) sei partito ieri
Gianni will say that you left yesterday

The complementizer can be deleted in sentence (74), but not in (75) and (76). This fact makes the absence of the DAR still more puzzling, given that according to the present analysis the speaker's temporal coordinate is represented in C.

Here I will briefly summarize the solution proposed in Giorgi (2010). I argue that these contexts are actually DAR ones, even if this claim seems to be contradicted by the data I just presented. The temporal reading of the embedded eventuality does not look like a DAR one because the speaker has *relocated* herself in the position of the subject. Hence, the embedded eventuality is indeed evaluated twice –once with respect to the speaker's temporal coordinate and once with respect to the subject's temporal coordinates– but on both occurrences the temporal coordinate is the one of the subject's. In other words: the speaker in these cases takes over the subject's perspective on events and the utterance time is not relevant anymore.

The arguments in favor of this proposal come from the distribution of temporal locutions. Temporal locutions in these sentences exhibit in fact several anomalies, which can be easily explained under the hypothesis that the speaker's temporal coordinate is indeed represented in the embedded clause, and that its value has been shifted from the utterance time to the subject's temporal location.

I distinguish here three types of temporal locutions: the *referential* ones –i.e., the 24th of May, June 2006, etc– the *indexical* ones –yesterday, last week, tomorrow morning, etc– and the *anaphoric* ones –the day before, the day after, etc.²⁸

Normally, both referential and indexical temporal locutions are compatible with whatever embedded clause:

(77) Gianni ha detto che Maria partirà il 28 agosto
Gianni said that Maria will leave(FUT IND) on the 28th of August

(78) Gianni ha detto che Maria partirà domani
Gianni said that Maria will tomorrow

²⁸. For an analysis of temporal locutions, see Giorgi and Pianesi (2003), Schlenker (2003).

In other words, it is always possible to use either the *proper name* of the relevant time, or the corresponding indexical, for instance *yesterday* or *tomorrow*.

Consider now the following sentence with a main future:

- (79) Gianni dirà che Maria è partita
Gianni will say that Maria left

As pointed out above, the following reading is possible:

- (80) *now*____leaving____saying

Let's suppose that *now* is located at the 27th of August, the leaving is placed on the 28th and that Gianni will talk on the 29th, as in the following example:

- (81) (Oggi è il 27 agosto) il 29 Gianni dirà che Maria è partita il 28
(Today is the 27th of August) on the 29th Gianni will say that Maria left on the 28th

In this case, however it is not possible to substitute the referential expression with the corresponding indexical –namely *tomorrow*:

- (82) *Il 29 agosto Gianni dirà che Maria è partita domani
On the 29th of August Gianni will say that Maria left tomorrow²⁹

The day of the leaving is indeed *tomorrow* with respect to the utterance time. Furthermore, indexicals are taken to be *rigid*, hence they should not be sensitive to the specific context in which they appear. Therefore the ungrammaticality of (82) is unexpected and calls for an explanation.

Consider the 'normal' ungrammatical case:

²⁹. It is indeed possible to use indexical temporal locutions corresponding to the following interpretation:

- (i) Leaving____*now*____saying
(ii) Gianni ha detto che Maria è partita ieri
Gianni said that Maria left yesterday

- (83) **Maria è partita domani*
 Maria left tomorrow

This sentence is ungrammatical because *tomorrow* places its argument, in this case the leaving event, in the future of the speaker, whereas the past tense places it in her past. Hence, the two cannot coexist.

My proposal is that *tomorrow* cannot be used in example (82) exactly for the same reason. We know that in clauses embedded under a future the embedded event is located with respect to the subject's coordinate, that is, with respect to the main event. Hence, the leaving is past with respect to the saying. Let's also suppose that the context is indeed a DAR one. Therefore, the embedded event should undergo a second evaluation with respect to the speaker's coordinate. Note that the indexical adverb already placed the event in the future of the speaker, a perfectly plausible option considering the speaker's actual temporal location.

But what if the speaker's temporal location in the embedded clause is not provided by the utterance time, *now*, anymore, but is made to coincide with the subject's one? In that case we would obtain a situation analogous to (83): The past tense on the verb locates the event in the past with respect to the subject's temporal location –by my hypothesis the speaker's temporal location as well– whereas the indexical *tomorrow* places the leaving in the speaker's future. Therefore, it gives rise to ungrammaticality in example (82), exactly as in example (83).

In what follows I will show that the speaker's temporal coordinate is indeed presented in C, even if it is not distinguishable from the subject's. It gives rise in fact to DAR effects detectable with anaphoric temporal locutions.

Giorgi and Pianesi's (2003) observed that anaphoric temporal locutions cannot occur in DAR contexts, and formulated the following generalization:

- (84) Anaphoric temporal locutions cannot be used for locating events that are in a direct relation R with the utterance event

This generalization, among other things, captures the following contrast:

- (85) *Questa mattina Gianni ha detto che Maria è partita ieri / ?* il giorno prima*
 This morning Gianni said that Maria left(PAST) yesterday / the day before
- (86) *Questa mattina Gianni ha detto che Maria era partita ieri /il giorno prima*
 This morning Gianni said that Maria had left(IMPF) tomorrow/ the day before

A past such as *è partita* in Italian is a DAR verbal form, whereas the corresponding imperfect one in (86) is not. The anaphoric temporal locution *il giorno dopo* (the day after) is not compatible with the former, but only with the latter.

One might expect the anaphoric locution to be available, contrary to facts:

- (87) Gianni dirà che Maria è partita ieri/ ?*il giorno prima
Gianni will say that Maria left(PAST) yesterday/ the day before
- (88) Gianni dirà che Maria era partita ieri/ il giorno prima
Gianni will say that Maria left(IMPF) yesterday/ the day before

If the embedded verbal form is an imperfect, then the anaphoric locution becomes available. This contrast can be explained under the hypothesis proposed above, according to which the contexts depending from a future are DAR ones, even if the speaker's temporal location is not different from the subject's one. Hence, an anaphoric temporal locution, which can never be placed with respect to the speaker is not available here.³⁰

6. Relative clauses

6.1. The issue

In this section I'll consider the distribution of temporal forms in relative clauses. I will not give an explanation as for why an indicative or a subjunctive appear, and will focus only on the temporal interpretation obtained in these cases.³¹

The hypothesis developed so far is that indicative embedded contexts are introduced by the left-most complementizer in the C-layer. The presence of this complementizer forces the embedded eventuality to be interpreted with respect to the speaker's temporal coordinate. Recall also that in the case of complement clauses, the main verb 'selects' the embedded verbal form –i.e., the embedded verbal form is realized as an indicative or a subjunctive, according to the nature of the main verb.

³⁰. Giorgi (to appear) considers the shifting of the speaker's coordinate part of the *meaning* of the future, similarly to counterfactual contexts.

³¹. For the subjunctive or relative clauses, see among the others Quer (1998, to appear).

As I illustrated above, the presence of the high C-projection plus the obligatory relation between the main verb and the embedded one gives rise to the DAR. This has been shown to take place in the case of indicative complement clauses, and in some cases of subjunctive clauses.

What prediction can be made at this point with respect to relative clauses? Note that relative clause can appear both with an indicative and with a subjunctive verbal form.³²

- (89) Gianni vuole sposare una donna che ha più di 40 anni
 Gianni wants to marry a woman who is(IND PRES) older than 40
 ‘Gianni wants to marry a certain woman who is older than 40’
- (90) Gianni vuole sposare una donna che abbia più di 40 anni
 Gianni wants to marry a woman who is(SUBJ PRES) older than 40
 ‘Gianni wants to marry any woman who is older than 40’

The difference between the sentence with the indicative relative clause and the one with the subjunctive one is the following: in the first case Gianni wants to marry a *certain*, specific, woman, who has the property of being older than 40. In the second case, Gianni wants to marry one non-specific woman, *whatever woman*, having the property of being older than 40. The difference in meaning is obviously connected to the difference in the mood selection, as discussed in the literature on the topic. Here I will take for granted the selection issue and consider the temporal interpretation in particular.

Given the framework above, in indicative clauses the presence of the left-most complementizer in the C-layer forces the interpretation of the embedded eventuality with respect to the speaker’s temporal coordinate. Hence, the prediction is that this will be true also of indicative relative clauses. Conversely, the presence of the subject’s temporal coordinate is not required in subjunctive contexts – because they are not complements of attitude predicates – hence, no subject-related temporal interpretation is predicted to arise (obligatorily) in subjunctive clauses.

³². In Italian the complementizer cannot be deleted in either case, presumably because it bears the *wh*-features of the clause.

6.2. Sequence of Tense in indicative relative clauses

It is well-known that relative clauses differ from complement clauses as far as their temporal interpretation is concerned. In particular, relative clauses can undergo the so-called *independent reading*. Consider for instance the following example:

- (91) Gianni ha invitato la donna che ha comprato il vestito rosso
Gianni invited the woman who bought(PAST IND) the red dress

The embedded verbal form is a past of the indicative. Compare it with the following sentence:

- (92) Gianni ha detto che Maria ha dormito
Gianni said that Maria slept(PAST IND)

The embedded event in this example had to be interpreted as preceding the superordinate one. A reading under which the saying event precedes that sleeping event is impossible, even if the sleeping is itself located in the past:

- (93) ____ sleeping ____ saying ____ now
(94) * ____ saying ____ sleeping ____ now

As I discussed above in section 2, the reason of such ungrammaticality across languages. Even in non-DAR languages such as Russian and Romanian – stems from the fact that SoT is obligatory, in the sense that the embedded event *must* be temporally located with respect to the subject's coordinate of the superordinate event. Being a past, it must be located in the past with respect to the saying, hence the interpretation in (94) is impossible.³³

No such requirement is at work with respect to sentence (91). It could very well be the case, therefore, that an interpretation of the kind given in (95) arises. As a matter of fact, the following interpretations are both possible:

³³. That interpretation would be equivalent to a *pure indexical* reading of the embedded verbal form, which is *a priori* excluded as discussed in section 2.

(95) ____ buy ____ invite ____ *now*

(96) ____ invite ____ buy ____ *now*

In other words, the only certain temporal relation that can be inferred from (91) is that the buying event occurred in the past with respect to the utterance event, i.e., to *now*. There is no ordering provided by the sentence between the event in the main clause and that in the relative clause, that is between the *inviting* and the *buying*.

Summarizing, this interpretation is due to the fact that in a relative clause the temporal coordinates of the attitude bearer are not represented in the T projection. In other words, the contrast between example (91) and example (92) arises from the fact that a sentence complement of an attitude predicate includes the syntactic representation of the bearer of the attitude, as originally proposed by Higginbotham (1995) and further elaborated by Giorgi and Pianesi (2000, 2001a). Conversely, a relative clause does not include the representation of the subject's attitude in T, because the main predicate does not express an attitude of the subject toward the content of the relative clause.

On the other hand, however, the embedded verbal form is an indicative one and, as such, it is introduced by the indicative-like complementizer, endowed with the speaker's temporal coordinate. Therefore, the embedded event undergoes the same mechanism illustrated above and ends up being temporally located with respect to the utterance event. Furthermore, the prediction following from the proposal illustrated so far is that this must be obligatory. This prediction seems to be borne out. Consider the following example:

(97) Gianni ha invitato una donna che comprerà un vestito rosso
Gianni invited a woman who will buy a red dress

Contrast it with the following one:

(98) Gianni ha invitato una donna che avrebbe comprato un vestito rosso
Gianni invited a woman who would buy a red dress

In example (97) the embedded event must obligatorily follow the utterance time, contrasting in this with the example (98), where, on the contrary, the future-in-the-past must follow only the event in the main clause. Again, this is what is expected under the hypothesis proposed above.

The interpretation of a present tense proceeds along a similar pattern:

- (99) Gianni ha invitato la donna che mangia un gelato
 Gianni invited the woman who eats (PRES IND) an ice-cream
 ‘Gianni invited the woman who is eating an ice-cream’

In this case, similarly to what illustrated above, the present tense event is interpreted as simultaneous with the utterance event –i.e., it is located with respect to the speaker’s temporal coordinate. It cannot be interpreted as simultaneous with the temporal location of Gianni. To express this meaning the imperfect of the indicative must be used. Consider for instance the following example:

- (100) Gianni ha invitato la donna che mangiava un gelato
 Gianni invited the woman who was eating (IMPF) an ice-cream

In this case, the imperfect follows the same rules I discussed above in section 4.3. Being an anti-speaker verbal form, the interpretation in (100) follows trivially. The embedded event is simultaneous only with respect to the main one and it is not ordered with respect to the speaker’s temporal coordinate.

Note however that the judgement concerning the interpretation of the relative clause event in (101) is quite subtle. Consider the following example:

- (101) Gianni ha invitato la donna che mangiava un gelato un momento fa
 Gianni invited the woman who was eating (IMPF) an ice-cream a moment ago

In this case the imperfect event is not located relatively to Gianni’s temporal coordinate, but to the speaker’s. *Un momento fa* (a moment ago) in fact is indexically interpreted, in the sense that it is computed starting from the speaker’s temporal coordinate, and the eating event is located accordingly. This case must be considered on a par with the canonical imperfect clauses:

- (102) #Gianni mangiava un gelato
 Gianni was eating(IMPF) an ice-cream
- (103) Un momento fa, Gianni mangiava un gelato
 A moment ago Gianni was eating(IMPF) an ice-cream

As I discussed above, a main sentence with an imperfect verbal form obligatorily requires a temporal topic. According to the hypothesis I developed in section 4.3, this effect stems from the anti-speaker requirement of the imperfect. The imperfect can never be directly related to the speaker's temporal coordinate, and when this is unavoidable, as in a main clause such as (102), the relation must be mediated by a temporal adverb. Note that example (102) could be acceptable as is, provided that a temporal topic is *understood*, because given in the preceding discourse.

Hence, in example (101), where the temporal topic is overtly provided, the imperfect can be temporally located with respect to it, in a way analogous to sentence (103). In example (100) this could still be possible, if the discourse provides for such a temporal topic, paralleling in this case the status of sentence (102).

Consider finally the future-in-the-past. An event in a complement clause, endowed with future-in-the-past morphology, is not evaluated against the speaker's temporal coordinate, but only with respect to the subject's. However, if an indexical temporal adverb appears, then the future-in-the-past event can be located accordingly:

(104) Gianni ha detto che Maria sarebbe partita domani

Gianni said that Maria would leave tomorrow

In sentence (104) the leaving event is located by means of the indexical temporal adverb *tomorrow*. In a relative clause, however, the future-in-the-past is not compatible with future oriented indexical adverbs:

(105) Gianni ha invitato la donna che avrebbe comprato un vestito rosso *domani

Gianni invited the woman who would buy a red dress *tomorrow

The only possible temporal locutions in this case are the anaphoric ones:

(106) Gianni ha invitato la donna che avrebbe comprato un vestito rosso il giorno dopo

Gianni invited the woman who would buy a red dress the next day

I propose that this different distribution of temporal locutions with the future-in-the-past can be explained by means of the consideration that this verbal form, contrary to the imperfect, is not available in main assertions, independently of the temporal locution:

(107) *Gianni avrebbe telefonato (domani/ il giorno dopo)

*Gianni would call (tomorrow/ the next day)

The sentence in (107) is never acceptable, not even with an indexical or anaphoric temporal locution.³⁴

Given this piece of evidence, it is possible to say that the future-in-the-past necessarily qualifies as an embedded verbal form. As such, it must be interpreted with respect to the superordinate one. The grammaticality of example (104), however, shows that the interpreting of the future-in-the-past event with respect to the subject is compatible with locating it with respect to the speaker as well.

In relative clauses however, the future-in-the-past event can only be interpreted with respect to the main event, because interpreting it with respect to the speaker's temporal coordinate would be equivalent to interpreting it as in isolation, which is impossible.

Summarizing so far: a relative clause with a past, a present or a future indicative form must obligatorily locate the embedded event with respect to the speaker's temporal coordinate. In an imperfect relative clause it is possible to locate it with respect to the speaker, provided that a suitable temporal topic is given, much as in main assertions. With the future-in-the-past this is impossible, because this verbal form can never be evaluated in main clauses against the speaker's temporal coordinate, neither directly – like the past, present and future of the indicative– or indirectly –like the imperfect.

From these considerations it follows that the event in indicative relative clauses is interpreted independently –i.e., as if it were a main clause– when it is a past, present or future. When it is an imperfect it is either interpreted as a dependent verbal form – analogously to the subjunctive, as I will illustrate in a while– or as an independent one. The imperfect in fact admits of both possibilities. The future-in-the-past only has the former possibility and can never locate the event with respect to the speaker's coordinate, unless derivatively. The different behavior of these forms with respect to the (other) indicative ones is to trace back to their non-relational status. They do not have to locate an event with respect to another one –as happens when the verbal form is a two-place predicate, *e R e'*– but must only be licensed in the proper way. The imperfect can

³⁴. The only possibility would be for it to be part of an *if*-clause:

- (i) Gianni avrebbe telefonato, se avesse potuto
Gianni would (have) called, if he could.

be licensed by a non-speaker temporal reference, and the future-in-the-past only by a superordinate event.³⁵

6.3. Subjunctive relative clauses

Consider now subjunctive relative clauses. Independently of what determines the presence of a subjunctive vs. an indicative, it is possible to see that the distribution of the verbal form is as expected, given the discussion so far. Consider for instance the following examples:

(108) Gianni vuole vedere un film che lo diverta/ *divertisse

Gianni wants(PRES) to watch a movie which amuses(PRES SUBJ/ *PAST SUBJ) him

(109) Gianni voleva vedere un film che lo divertisse/ *diverta

Gianni wanted(PAST) to watch a movie which amused(PAST SUBJ/ *PRES SUBJ) him

If the verb of the main clause is a present tense, then the embedded subjunctive form is a present. Conversely, if it is a past, then the embedded verbal form is a past. As expected, the past subjunctive under a present tense, and the present subjunctive under a past tense are not acceptable. Again, this pattern is expected under the tense agreement hypothesis: the subjunctive does not express a temporal relation, but only a morphological relation.

7. Concluding remarks

In this article I discussed the properties of complement and relative clauses in Italian with respect to Sequence of Tense. I proposed a unified account, able to distinguish between DAR contexts and non-DAR ones. The DAR effect arises as a double evaluation of the time of the embedded event. In DAR clauses the embedded event ends up being evaluated once with respect to the subject's coordinates –and this is obligatory

³⁵. Here I will only address the issue descriptively and will not discuss here why the future-in-the-past has precisely this property. For further discussion, I refer the reader to Giorgi (2008, ch. 4).

for all complement clauses in every language— and once with respect to the speaker’s temporal coordinate. The speaker’s temporal coordinate is represented in the left-most position of the C-layer.

By means of this very simple machinery, it is possible to handle the complex syntactic and interpretive distinctions between indicative and subjective clauses –including the anomalous cases in dependence of a predicate such as *ipotizzare* (hypothesize)— and to account for the properties of the imperfect and the future-in-the-past. Moreover, I also accounted for a *prima facie* exception to this picture –i.e., the apparent lack of DAR effects in the clauses embedded under a future verbal form.

Finally, I also show that it is possible to describe and explain the various readings of embedded verbal forms in relative clauses, without the necessity of a *special proviso* for their so-called *independent* reading.

References

- Abusch, D. 1997. “Sequence of Tense and Temporal De Re”. *Linguistics and Philosophy* 20, 1-50.
- Bertinetto, Pier Marco. 1997. *Il Dominio Tempo-Aspettuale: Demarcazioni, Intersezioni, Contrasti*. Turin: Rosenberg and Sellier.
- Bertinetto, Pier Marco and Denis Delfitto. 2000. “Aspect vs. Actionality: Why They Should Be Kept Apart”. In Östen Dahl (ed.), *Tense and Aspect in the Languages of Europe*. Berlin: Mouton de Gruyter. 189-225.
- Bertinetto, Pier Marco. 1986. *Tempo, Aspetto e Azione Nel Verbo Italiano: Il Sistema dell'indicativo*. Firenze: Accademia della Crusca.
- Bianchi, Valentina. 2003. “On finiteness as logophoric anchoring”. In Jacqueline Guéron, Liliane Tasmosky (eds.), *Perspective and Point of View*, University of Paris X Press, Paris. 213-246.

- Bianchi, Valentina. 2006. "On the syntax of personal arguments". *Lingua* 116, 2023-2067.
- Bianchi, Valentina, Mario Squartini and Pier Marco Bertinetto. 1995. "Perspective Point and Textual Dynamics". In Pier Marco Bertinetto, Valentina Bianchi, James Higginbotham, and Mario Squartini (eds.), *Temporal Reference, Aspect, and Actionality*, Vol. I. *Semantic and Syntactic Perspectives*. Torino: Rosenberg and Sellier. 309-324.
- Bonomi, Andrea and Alessandro Zucchi. 2001. *Introduzione alla semantica del tempo e dell'aspetto verbale*. Milano: Bruno Mondadori.
- Calabrese, Andrea. 1984. "Una differenza sintattica fra il salentino e italiano: la complementazione frasale". *Rivista di Dialettologia*, VIII. 195-203.
- Costantini, Francesco. 2005. *On Obviation in Subjunctive Clauses*, PhD. Diss., University of Venice, Italy.
- Costantini, Francesco. 2008. "On Tense Mismatch and a Theory of Sequence of Tenses". *Ms.*, University of Venice, Italy.
- Delfitto, Denis and Pier Marco Bertinetto. 2000. "Word Order and Quantification over Time". In J; Higginbotham, F. Pianesi & A.C. Varzi (eds.), *Speaking of Events*. New York: Oxford University Press.
- Giorgi Alessandra. 2006. "From temporal anchoring to long distance anaphors". *Natural Language and Linguistic Theory* 24.4, 1009-1047
- Giorgi Alessandra. 2007. "On the Nature of Long Distance Anaphors". *Linguistic Inquiry* 38.2, 321-342.
- Giorgi, Alessandra. 2010. *About the Speaker: Towards a Syntax of Indexicality*. *Oxford studies in Theoretical Linguistics* 28. UK: Oxford University Press.
- Giorgi, Alessandra and Fabio Pianesi. 1997. *Tense and Aspect: From Semantics to Morphosyntax*, New York: Oxford University Press.
- Giorgi, Alessandra and Fabio Pianesi. 2000. "Sequence of Tense Phenomena in Italian: a Morphosyntactic Analysis". *Probus*, 12, 1-32.
- Giorgi, Alessandra and Fabio Pianesi. 2001a. "Tense, Attitudes and Subjects". In R. Hastings, B. Jackson, Z. Zvolenszky (eds.), *Proceedings of SALT XI*, CLC Pub., Cornell Univ. USA.
- Giorgi, Alessandra and Fabio Pianesi. 2001b. "Imperfect Dreams. The temporal dependencies of fictional predicates". *Probus* 13, 31-68.
- Giorgi, Alessandra and Fabio Pianesi. 2003. "The Day after: anaphoric temporal locutions". In Jacqueline Guéron and Liliane Tasmovsky (eds.), *Perspective and Point of View*, Paris: University of Paris X Press. 128-171.

- Giorgi, Alessandra and Fabio Pianesi. 2004a. "Complementizer Deletion in Italian". In Luigi Rizzi (ed.), *The Syntax of CP and IP*, New York: Oxford University Press.
- Giorgi, Alessandra and Fabio Pianesi. 2004b. "The Temporal Perspective of the Speaker and the Subject: from Semantics to Morphosyntax". In: Jacqueline Guéron and Jacqueline Lecarme (eds.), *The Syntax of Time*. Cambridge, Mass.: MIT Press. 129-152.
- Higginbotham, James. 1995. "Tensed Thoughts". *Mind and Language* 10.3, 226-249.
- Higginbotham, James. 2001. "Why is Sequence of Tense Obligatory?". In G. Preyer and E. Lepore (eds.) *On Logical Form*. New York: Oxford University Press.
- Ippolito, Michela. 2004. "Imperfect Modality". In J. Guéron and J. Lecarme (eds.), *The Syntax of Time*. Cambridge, Mass.: MIT Press. 359-387.
- Kaplan, D. (1979) 1989. "Demonstratives" In J. Almog, J. Perry and H. Wettstein, *Themes from Kaplan*. New York: Oxford University Press.
- Ogihara, T. 1995. "Double-Access Sentences and Reference to States". *Natural Language Semantics* 3, 177-210.
- Ogihara, T. 1996. *Tense, Attitudes and Scope*. Dordrecht: Kluwer Academic Press.
- Pesetsky, D. and E. Torrego. 2004. "The Syntax of Valuation and the Interpretability of Features". To appear in: S. Karimi, V. Samiian and W. Wilkins (eds.), *Clausal and Phrasal Architecture: syntactic derivation and interpretation*. Amsterdam/Philadelphia: Benjamins.
- Pesetsky, D. and E. Torrego. 2006. "Probes, Goals and Syntactic Categories". *Proceedings of 7th Annual Tokyo Conference on Psycholinguistics (2006)*, Keio University: Yukio Otsu, ed.
- Poletto, Cecilia. 2000. *The Higher Functional Field*. New York: Oxford University Press.
- Poletto, Cecilia. 2001. "Complementizer Deletion and Verb Movement in Standard Italian". In G. Cinque and G.P. Salvi, *Current Studies in Italian Syntax*, Amsterdam: Elsevier. 265-286.
- Quer, Josep (ed.). to appear. Monographic issue of *Lingua* on Subjunctive.
- Quer, Josep. 1998. *Mood at the Interface*. The Hague: HAG.
- Rizzi, Luigi. 1997. "The Fine Structure of the Left Periphery". In Haegeman, L. (ed.), *Elements of Grammar*. Amsterdam: Kluwer. 281-337.
- Rizzi, Luigi. 2001. "On the position of Int(errogative) in the Left Periphery of the Clause". In G. Cinque and G. Salvi (eds.), *Current Studies in Italian Syntax*. Amsterdam: Elsevier. 287-296.

- Rizzi, Luigi. 2002. "Locality and left Periphery". In A. Belletti (ed.), *Structures and Beyond. The Cartography of Syntactic Structures*, vol. 3. New York: Oxford University Press.
- Schlenker, P. 2003. "A Plea for Monsters". *Linguistics and Philosophy* 26, 29-120.
- Schlenker, P. 2005. "The Lazy Frenchman Approach to Subjunctive". In T. Geerts, I. van Ginneken and H. Jacobs (eds.), *Romance Languages and Linguistic Theory*. Amsterdam/Philadelphia: Benjamins. 269-309,
- Stowell, Tim. 1996. "The Phrase Structure of Tense". In J. Roorick and L. Zaring (eds.), *Phrase Structure and the Lexicon*, Dordrecht: Kluwer Academic Publishers. 277-291.
- Vet, Co. 1985. "Univers de discours et univers d'Enonciation: le Temps du Passé et du Futur". *Langue Française*, 67, 38-58.
- Zagona, Karen. 1995. "Temporal Argument Structure: Configurational Elements of Construal". In Pier Marco Bertinetto, Valentina Bianchi, James Higginbotham, and Mario Squartini (eds.), *Temporal Reference, Aspect, and Actionality*, Vol. I, *Semantic and Syntactic Perspectives*. Torino: Rosenberg and Sellier.
- Zucchi, Alessandro. 2001. "Tense in Fiction". In C. Cecchetto, G. Chierchia and M.T. Guasti (eds.), *Semantic Interfaces: Reference, Anaphora and Aspect*. Stanford: CSLI Publications.

On feature sharing and feature transfer¹

Giuliana Giusti

University of Venice

Feature sharing is a pervasive property of natural languages which has long been considered quite puzzling. Being the source of redundancy, it is potentially a major problem in the minimalist program which aims to reduce language to a conceptually necessary system (cf. Chomsky 2005). For this reason it has been the focus of so much literature in the last decade that it is impossible to mention even the most influential pieces of work. In this paper, I claim that feature sharing is a non-homogeneous phenomenon and should be analyzed as the result of three different processes *Agreement*, *Concord*, and *Projection*.

In current literature, feature transfer is reduced to checking and deleting uninterpretable features (Chomsky 1995). I adopt the mainstream hypothesis that Agreement arises from merger of a formal uninterpretable feature (a probe) and is checked against a constituent (the goal), in a lower specifier, which contains the interpretable counterpart of those features. This triggers movement (copy and re-merge) of the relevant features to obtain a Spec-Head configuration with the probe, resulting in either covert movement (only the feature moves) or overt movement (the moved feature pied-pipes the whole constituent which contains it). I claim that quite differently from Agreement, Concord arises from the first-merger of a modifier underspecified for uninterpretable features. In other words, Concord is directly enhanced by the Spec-Head configuration, it does not

¹. Preliminary versions of this work have been presented in a research seminar at the University of Leiden in October 2009 and at the Aarhus Workshop on Clausal and Nominal Parallels in November 2009. I thank the audiences for constructive criticism and support, and in particular Lisa Cheng, Elisabeth Cowper, Roberta D'Alessandro, Sten Vikner, Johanna Wood and Norbert Corver. I also thank Gabriella Hermon, Peter Cole for discussing parts of this work during the summer 2008.

University of Venice

Working Papers in Linguistics

Vol. 19, 2009

involve merger of a probe targeting a goal, and never triggers overt or covert movement. Finally, Projection is triggered by iterated internal merge of features that build a fully fledged constituent, an “extended projection” in the sense of Grimshaw (1991), as I already suggested in Giusti (2002).

This proposal motivates a well-known tripartition traditionally noticed for the clause in the late principles-and-parameters framework and best stated by Rizzi (1997), and its parallel in the nominal expression also well-known and stated a.o. by Cornilescu (1995). It also derives another often noticed and never motivated fact, namely that nominal expressions behave in a defective, more reduced fashion if compared to clauses. Together with these general results, it preserves the Agree relation which involves a probe and a goal only in the cases in which this is independently needed while it dispenses with such operations in the case of adjectival modification, where this is not motivated at all. Finally, it derives a number of differences between Agreement and Concord, among which the fact that subjects are unique, while modifiers are iterated.

The paper is structured as follows. Section one motivates the parallel between nominal expressions and clauses suggesting that the operation Merge is driven by three kinds of relation: selection, projection, and modification. The interaction of these three relations derives the tripartite form of these two syntactic constituents into an internal lexical layer, an intermediate functional layer and an external complementation layer. Section 2 takes the process of Agreement into the picture and argues that this is the only kind of process that involves a probe and a goal which moves to the Spec of the goal. Section 3 introduces a different kind of feature sharing which I name Concord and its interaction with the process of Projection. Concord is the result of modification which takes place in a straightforward Spec-head configuration and does not involve any movement.

Before proceeding to the discussion, let me first introduce a terminological distinction. Nominal structure is “almost” as complex as clausal structure and the labels NP, noun phrase, or DP are no longer suitable to refer to the whole nominal constituent, because these labels also refer to portions of structure, in turn assumed to consist in projections split in different fashions according to different theories. Competing analyses often differ on exactly one label or on the number of these split projections in one area or another. A term parallel to “clause” is therefore needed for us to formulate empirical generalizations without taking stand for a particular analysis. The fully spelled “noun phrase” is too reminiscent of the most internal projection for it to be apt to refer to the whole structure, while the label DP may refer to the highest constituent or to the whole highest layer, or even to a part of it, and would again lead to ambiguity. For these reasons, following a suggestion by Mila Dimitrova-Vulchanova (p.c.), I propose to use

“nominal expression” (or NE) to refer to the whole nominal constituent when we want to remain agnostic as regards the very nature of the topmost projection.

1. On motivating the parallels in clausal and nominal structure

In the generative tradition, the study of the nominal expression has always received an attention constantly mirroring the research done on the structure of the sentence. The nominal expression has been expanded to contain an indefinite number of functional heads, with their specifiers and adjuncts, obtaining a vast structure including “split projections” parallel to clausal ones: an NP-shell (or nP) parallel to the VP-shell (or vP), an intermediate functional area formed with an indefinite number of projections related to adjectival modification parallel to adverbial modification in the clause, and a split DP representing different interpretive features parallel to the split CP.

- (1) a. [CP (Complementation layer) [IP (Inflectional layer) [VP (lexical layer)]]]
 b. [DP (Complementation layer) [AgrP (Inflectional layer) [NP (lexical layer)]]]

In the structures in (1), the internal layer establishes the selectional requirements of the lexical head (including theta relations) with its arguments, the highest of which is singled out to satisfy the an EPP feature (obligatory in the clause and optional in the NE) merged at the left edge of the intermediate layer. This layer is also available to merger of modifiers (adverbs or adjectives). The external layer hosts clausal complementizers and nominal determiners, it provides the landing site of operators that contribute to the interpretation of the whole constituent, the escape hatch position for extraction and optionally one or more position for movements producing marked orders. Despite these crucial parallels, NEs are known to display a “defective” behavior if compared to clauses summarized in (2):

- (2) a. reduced capacity of expansion in each of the three layers,
 b. optionality of arguments (and in particular of the external argument),
 c. only one structural case, often none, very rarely two.
 d. highly restricted occurrence of pronominal clitics,
 e. lack of interrogative features

In a minimalist approach to language, both the necessity of a tripartition in the structure of nominal and clausal expressions and its imperfect realization in the former can either be viewed as an accident due to the biological nature of UG, or as a necessity due to its logical properties and interpretive features. The latter possibility is the null hypothesis. I suggest that the tripartition is due to three independently needed relations that govern merger in syntax: *selection*, *modification*, *projection*. Selection is the relation between a lexical head and its argument and is represented by the lower arrows. Modification is the relation between a fully fledged constituent and a lexical head and is represented by the superscripts. Projection is the relation between a lexical head and the formal features in its functional layers merged in functional heads and is represented by the upper arrow:

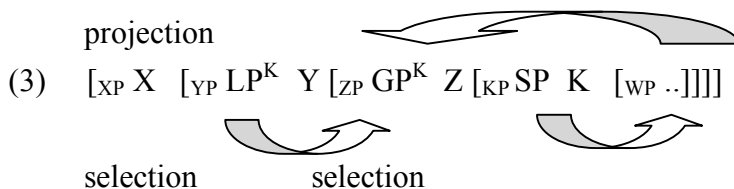

In (3), Selection merges a lexical head K which is specified in the lexicon for selectional feature) with a fully fledged constituent WP (or “perfect projection” in the sense of Grimshaw 1991) that can satisfy such selectional features. Projection merges the interpretable and uninterpretable features associated with the lexical item K in the lexicon into functional heads such as Z and Y (and as many as the structure building procedures requires). Modification merges a fully fledged constituent (e.g. LP, GP, or SP) with a projection of the head K. A modifier can directly merge with K’ (as is the case of SP) or to a projection of K (Y’, as is the case of GP, or Z’ as is the case of LP). Each of the above operations involves feature transfer. Selection transfers selectional features (theta-roles, lexical case, etc.) from the lexical head K to the fully fledged constituent (its complement WP); projection copies (a bundle of) interpretable and uninterpretable feature of the head K to create a skeleton in which modifiers may be merged (if present) and these features are shared by all layers up to the external layer YP (namely, the constituent which satisfies the selectional requirement of the lexical head X). Modification transfers of the features of the lexical head onto the modifier. Next section focuses on how mainstream literature captures the canonical case of feature transfer, namely the transfer of the person features of the subject onto the inflectional morphology of the predicate.

2. Agreement

Agreement in the clause is assumed to take place to satisfy an EPP feature of T (cf. Hornstein, Nunes and Grohman 2006, Pesetsky and Torrego 2001). In other words, to enhance predication in the clause an argument merged in the lexical layer must be promoted to the function of “subject”. The EPP feature is associated to the highest head in the intermediate layer (call it TP). Agreement is the result of a special kind of selection by this functional head T (the probe), which has an uninterpretable nominal feature (the EPP feature) to be deleted after targeting a fully fledged constituent with an interpretable counterpart. This feature matching results in (abstract) Case assignment onto the fully fledged constituent and may result in overt inflectional morphology for person features onto the verbal projection, according to specific inflectional properties of the probe. The movement that follows Agreement in some languages is also related to a specification of the probe and is independent of the Agreement process itself:

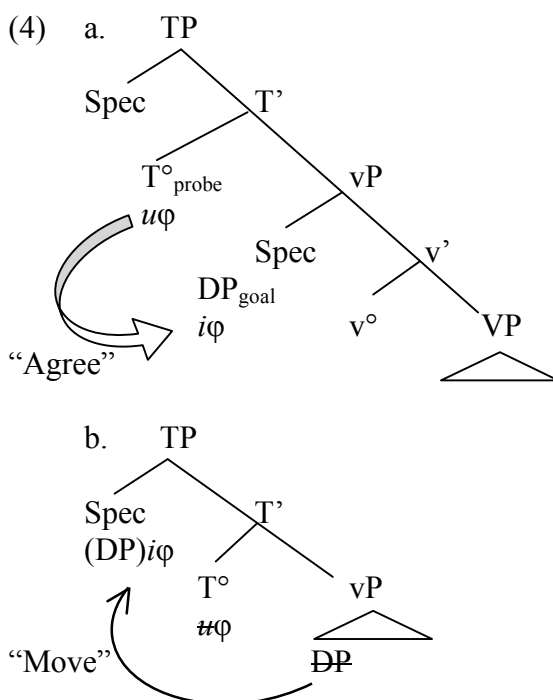

The EPP-feature on T is a defining property of the clause. I propose this is due to the interpretive properties of a clause, which can have a value only if the situation is true/false at a given TIME as predicated of a given SUBJECT. The interpretation of a clause must involve the intersection between the reference of the subject and the temporal reference of the situation. Nothing of the kind holds for NEs, whose reference

is obtained by insertion of a particular kind of specifier. If a NE is contained in a NE, the reference of the two expressions interact in a different fashion. For this reason I take Agreement in the NE to be of a different kind than the Agreement we find in clauses. Agreement in the NE is not related to Tense, and is not a constitutive part of NE.

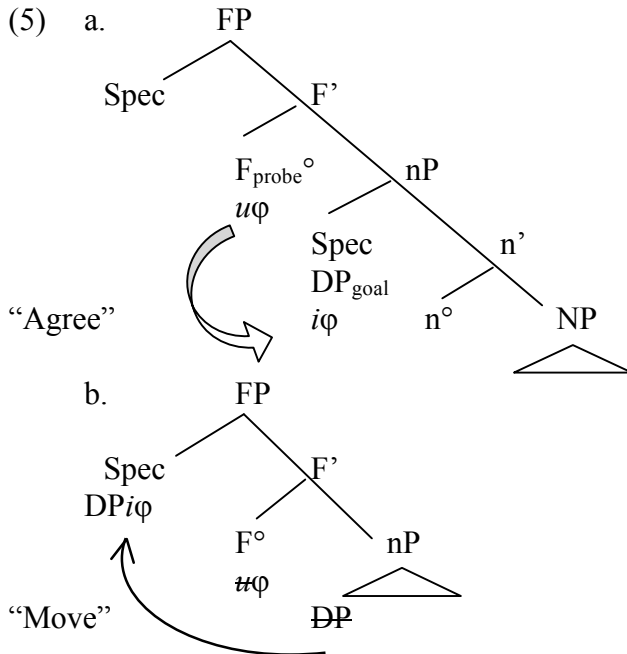

In (5) FP is the highest projection in the intermediate layer. This is clear in Hungarian (6) which also shows that person features transfer from the possessor onto the noun:

- (6) a. az en kalapom Szabolcsi (1987, 1994)
 the I-Nom. hat-1 pers. sing
 b. a te kalapod
 the you-Nom hat -2 pers. sing
 c. a Mari kalapja
 the Mari-Nom hat -3 pers. sing

And it can also be claimed for Italian, as shown in the following examples which I take from Giusti 2008. In (7) we observe that while for full possessors the unmarked order is NSO but the order NOS is marginally possible, with a possessive adjective the unmarked order is SNO, and the possible marked order is NSO, but no NOS. Furthermore, if a possessive adjective co-occurs with a full NE, the possessive adjective must receive the external theta role (7b). Finally, only one possessive adjective is possible in a NE (7c):

- (7) a. la vecchia fotografia sbiadita di Gina di Mario
 the old faded picture of Gina of Mario
 “Gina’s old faded picture of Mario/#Mario’s old faded picture of Gina”
- b. la {sua} vecchia {*sua} fotografia sbiadita di Mario
 “her old faded picture of Mario”/ *”Mario’s old faded picture of her”
- c. *la mia {tua} fotografia {tua} / la mia fotografia di te
 “my picture of you”

In (8) the intermediate layer FP is associated with AGREE which targets the FF features of NE (DP or pronoun) merged in the internal layer. (8) does not explain what these features are and why adjectival possessives are moved out of the lexical layer while full DPs (embedded into a PP) cannot:

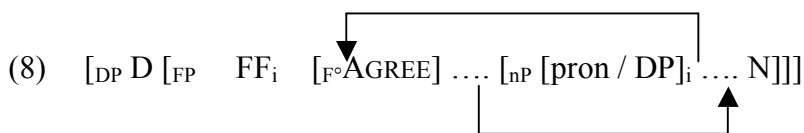

A plausible reason for movement of a possessive adjective to the specifier of FP could *prima facie* be its adjectival nature. If the possessive adjective is merged in NP (or nP), one may suppose that this position does not allow for adjectival Concord and the possessive adjective must move to a Specifier in which such concord takes place. This would however lead to unwelcome empirical and theoretical results. From the latter point of view, I want to keep Concord as a relation between a Spec and a head, without any further specification. This is a good result in the minimalist perspective and should not be dispensed with without strong reasons to the contrary. The empirical side is independent of this theory-internal reason.

First of all, let us observe that relational adjectives, which also receive a theta-role, never move and are always postnominal (9), while possessive adjectives, which can be postnominal in the marked order, are moved in the unmarked case (10):

- (9) a. la vecchia opinione razzista italiana
 the outdated opinion racist Italian
- b. *L’italiana vecchia opinione razzista
 the Italian outdated opinion racist
 “the outdated Italian racist opinion”

- (10) a. ?la vecchia opinione razzista tua
the outdated opinion racist your
b. la tua vecchia opinione razzista
the your old opinion racist
“your outdated racist opinion”

If adjectival concord can be satisfied in the postnominal position for relational adjectives, it should be so for possessive adjectives, as probably is in (10a).

A second piece of evidence is the observation that the third person possessive *loro*, with no adjectival concord, has the same distribution as possessive adjectives (11a):

- (11) a. la {loro} vecchia {*loro} fotografia sbiadita {?loro}
the {their} old {*their} picture faded {?their}
“their old faded picture”
b. la {loro} vecchia {*loro} opinione razzista {?loro}
the {their} old {*their} opinion racist {?their}
“their old racist opinion”

Final counterevidence is the fact that in special formal, bureaucratic, or playful registers mimicking Old Italian, personal pronouns appear in the high position even embedded in a *di*PP (12), while full DPs cannot (13):

- (12) a. con una nuora autoritaria e **le di lei** tre figlie
with a bossy daughter-in-law and the of her three daughters
<http://www.pannostrale.it/scheda.php?compagnia=I+TEATRANTI> (march 2007)
b. Applausi scroscianti in sala e sorriso stellare sulle labbra del protagonista, mentre **il di lui** cane - di nome Pinocchio - zampetta giocoso sul palco del Teatro dell'Arte, e **la di lui** figlia - Teresa - abbozza un accenno di pianto fra le braccia di mamma Francesca, e **la di lui** band - Saturnino in primis - osserva l'intera scena ...
the of him dog ... the of him daughter ... the of him bad
http://www.mybestlife.com/ita_anima/Jovanotti_Autobiografia_di_una_festa_sito.htm
(march 2007)
c. Allora i de Cristofaro scaricano **i di loro** schioppi contro Ramaglia
Then the de Cristofaro's fire the of them rifles against Ramaglia

- (13) a. **le di sua nuora tre figlie*
 the of his daughter-in-law three daughters
 b. **i dei de Cristofaro schioppi*
 the of the De Cristofaro rifles
 c. **il di Jovanotti cane / la di Jovanotti figlia /*la di Jovanotti band*
 the of Jovanotti dog/daughter/band

These facts support the proposal that what triggers raising of the possessive adjective in Italian is not its adjectival nature but its pronominal reference. In other words, the movement of possessive adjectives and pronouns is independent of the Concord which the former undoubtedly display, and is triggered by Agreement, parallel to what happens to subjects in the clause. More precisely Nominal Agreement targets the Person features of the possessor in order to put the NE in the Spec of the left edge of the external layer (DP), where the R-relation established in nP is interpreted at LF.

I propose that possessive adjectives and pronouns move because they uniquely consist in person features, targeted by AGREE. Person features in Italian are supposedly not strong enough to pied-pipe the whole NE, but if there is nothing to pied-pipe (as is the case of the personal pronoun *loro* and possessive adjectives) the unmarked choice is to realize the upper copy. Notice that the possessive pronouns embedded in a PP in (12) can, in particular registers, pied-pipe the PP. The structure in (8) must therefore be reformulated as in (14):

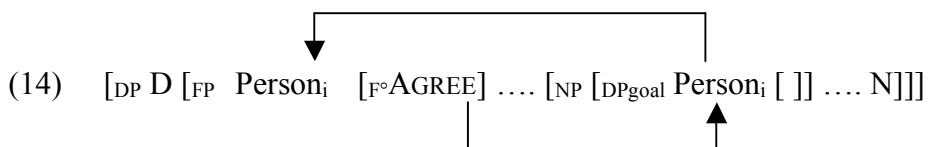

If it is a matter of strength, we expect variation across languages. Germanic languages obligatorily move both pronominal and DP possessors, but not PPs. Hebrew seems to leave open the possibility of moving both pronominal and DP possessors in construct state or merging both pronominal and DP possessors in a PP in free state. (cf. Ritter 1991, Siloni 1997 a.o.). Romance languages other than Italian only move pronominal possessives which are defective in nature (cf. Cardinaletti 1998, Giusti 2002). An different case is found in Romanian genitive construction which present apparent similarities to Hebrew but with interesting differences, as discussed by Dobrovie-Sorin (2000). For space reasons we refer the reader to Giusti (2008) on how to accommodate Romanian in this proposal.

3. Projection and Concord

In this section I reformulate what is suggested in Giusti 2002. I follow Cinque's (1994, 1999) seminal idea of a functional hierarchy of modifiers but I depart from Cinque's proposal in two respects. I propose that the hierarchy of modifiers is not the result of projection. Functional heads in the inflectional layer are not labeled for these semantic features but are trivial copies of the ϕ -features of the head noun (i.e. number and gender or word class and case). The features are bundled together in the sense of Matushansky (2006). I follow Giorgi and Pianesi's (1997) proposal that functional features are ordered hierarchically by the *Universal Ordering Constraint*, but the hierarchy is not violated if two or more features are bundled in one and the same head, as stated by the *Feature Scattering Principle*

(15) a. **Universal Ordering Constraint**

Features are ordered so that given $F_1 > F_2$, the checking of F_1 precedes the checking of F_2 .

b. **Feature Scattering Principle**

Each feature can head a projection

This proposal is that it can dispense with empty (or inert) functional heads and specifiers. A head is projected only if needed and more features can be bundled in one and the same head provided they do not violate the hierarchy. Projection simply copies the bundle of nominal features in a bottom-up fashion to build the extended constituent.

(16) Economy in projection. Copies can be silent (and therefore must, due to economy) if the uninterpretable features of the Specifier are erased.

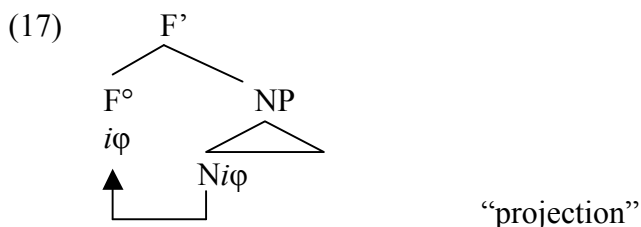

The interpretable features in NEs identify the referent while the uninterpretable feature regards the selectional relation of an external head, namely the theta role assignment and consequent Case assignment to the NE, and can regard the AGREE head above.

- (18) a. Gender is specified on N in the lexicon, or derived in distributed morphology.
 b. Number is projected in the inflectional field.
 c. Person/Deixis/definiteness (a referential index) is interpreted at the left edge of the NE (possibly merged lower, in nP).
 d. Case is uninterpretable but allows for a the theta-role assigned externally to be interpreted on NE.
 e. An AGREE head with an EPP Person feature is merged if needed to establish a Modification relation with a NE with a different index.

The internal merge procedure may involve the lexical head bundled with all its projection, or just part of the bundle, but always in compliance with the feature scattering principle. For example the bundle of {N, [Masch], [Sing], [3rdP], [nominative Case]} can be realized as a unique word in Romanian or Danish (19a) or can be split in two heads in Italian and German (19b):

- (19) a. băiatul / gutten “the boy”
 b. il ragazzo / der Jung

If it is realized in two different words (19b), some of the features (in this case {[Masch], [Sing]}) can appear twice. In Italian it is once bundled with N *ragazzo* and once bundled with the article *il*. In German, the N *Jung* is intrinsically {[Masch], [Sing]} and these features are overtly realized bundled with Case only on the article *der*. Notice that in one and the same language the possibility of overt realization depends on the value of a single feature of the bundle. For example, if Case is partitive, also Romanian and Danish realize the features as split:

- (20) a. un băiat / en gutt “a boy”
 b. un ragazzo / ein Jung

In the cases (19)-(20) above, the highest copy is the article in D. If SpecDP contains a determiner which in turn inflects for the same features, the article is non overt. (Cf. Brugé and Giusti 1996, Brugé 2002, Giusti 2002, Cardinaletti and Giusti (to appear)). This is due to the fact that determiners such as demonstratives are modifiers and behave parallel to other modifiers of the NE, as will be argued for in a moment.

In many languages, including Romance, most Germanic (with the exclusion of English) and Slavic, adjectives are associated with a number of uninterpretable features. For

example in German, Adjectives have two possible declensions (weak and strong) that are sensitive to gender, number, case, and definiteness. Let's assume that adjectives are associated in the lexicon with an uninterpretable specification of such features. I propose that such u-features are deleted when they are merged in the specifier of a head containing a copy of a bundle of the same features which are interpretable in the nominal expression:

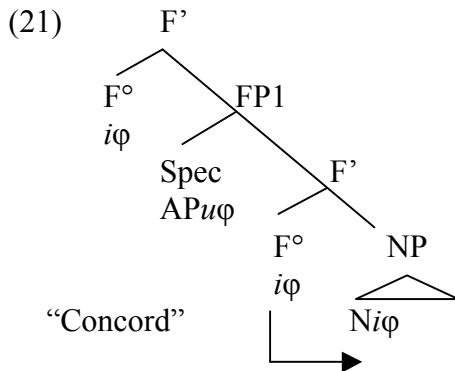

This proposal captures the fact that ordered adjectives display concord for the same bundle of formal features, and not for separate features (such as gender, number, or speaker-orientation, size, etc.). It also captures the observation, also made by Carstens (2001), that agreement in the clause results in sharing the features of the subject with the inflectional morphology of the verb (the lexical head in the clause), while nominal concord is quite the opposite in that it consists in sharing the features of the lexical head N with its modifiers. Carstens (2001:332, ex.(28)) unifies the two procedures by assuming that also adjectival agreement is triggered by targeting a lower element (AP or DP merged inside NP) and attracting it to its Spec. I take the opposite direction here.

While for possessives we have evidence for a base and a derived position, there is no such evidence for other adjectives. Furthermore, apart from possessive and relational adjectives, adjectives do not saturate the thematic requirements of N. Finally, in the perspective of a parallelism with the clause, adjectives are to be compared to adverbs, which never (need to) A-move. I therefore propose that the feature sharing resulting from Concord is not obtained by movement but is the result of external merge of a modifier in a functional Specifier. The Spec-Head configuration transfers the uninterpretable features of N moved onto the functional structure of the Adjective (its external layer, which is not represented here for practical reasons).

An Italian NE with two prenominal and one postnominal adjective is given in (22) as an example. The lexical N *ragazze* with its {[Fem], [Sing]} features moves out of NP (i.e.,

it is copied and re-merged as $F1^\circ$). In this way, it instantiates the first FP, in whose Spec an AP is merged. The values for Num and Gen are transferred to the first modifiers, as in (22a). In Romance, the bundle $\{N [iNum], [iGen]\}$ *ragazze* is projected (internal merge) in $F1^\circ$. If more than one adjectival modifier is present in the lexical array, merger of other APs proceeds in the same fashion, subject to the universal hierarchy of adjectival modifier. In (22b), the evaluative adjective *belle* is inserted in SpecFP1 and the features bundled with N is transferred to it. The head N in Romance does not move any further (for reasons that are not completely clear), but silent copies of the bundle keep moving creating as many FPs as needed for the merging of the adjective phrases present in the lexical array as is the case of FP2 in (22c). When the last FP containing the hierarchically higher adjective is merged, the highest layer is created to host the edge of the NE where the reference features of NE are merged. If these features are covert, as is the case of the operator R in (22d), its interpretable features are overtly realized on a dummy head, namely the definite article:

(22) *le altre belle ragazze italiane*

the other nice girls Italian

“the other nice Italian girls”

- a. $[_{F1'} [_{F^\circ 1} ragazze[*iFem, iPl*]] [_{NP} [_{APitaliane}[*\#Fem, \#Pl*]] [_{N'} ragazze[*iFem, iPl*]]]]$
- b. $[_{FP1} [_{AP} belle[*\#Fem, \#Pl*]] [_{F1^\circ} ragazze[*iFem, iPl*]] [_{NP} [_{APitaliane}[*\#Fem, \#Pl*]] [_{N^\circ} ragazze[*iFem, iPl*]]]]]]$
- c. $[_{FP2} [_{AP} altre[*\#Fem, \#Pl*]] [_{F2^\circ} 0[*iFem, iPl*]] [_{FP1} [_{AP} belle[*\#Fem, \#Pl*]] [_{F1^\circ} ragazze[*iFem, iPl*]] [_{FP1} [_{AP} italiane[*\#Fem, \#Pl*]] [_{F^\circ 1} ragazze[*iFem, iPl*]] [_{NP} ragazze[*iFem, iPl*]]]]]]]]$
- d. $[_{DP} R_j[*\#Fem, \#Pl*] [_{D^\circ} le[*iFem, iPl, uCase*]] [_{FP3} [_{AP} altre[*\#Fem, \#Pl*]] [_{F^\circ 3} 0[*iFem, iPl*]] [_{FP2} [_{AP} belle[*\#Fem, \#Pl*]] [_{F^\circ 2} ragazze[*iFem, iPl*]] [_{FP1} [_{AP} italiane[*\#Fem, \#Pl*]] [_{F^\circ 1} ragazze[*iFem, iPl*]] [_{NP} ragazze[*iFem, iPl*]]]]]]]]]]$

In Giusti 1997, 2002, I proposed that the position relevant for the interpretation of the NE is not D° but its specifier, in the present terms the left edge of NE. D° is the head in which Case is assigned. And the different articles (definite/indefinite) are bundles of Case Number and Gender features which licences an empty operator (as proposed in Campbell 1996). The present proposal is in the same spirit. Concord features are merged to allow for what is merged in the Specifier (the edge of the NE) to copy the features of NE. I will next claim that the reference features of NE are merged at the left

edge and combine with the reference features of NE_{goal} merged in the immediately lower specifier.

I have assumed in (14) above that the Referential operator of NE is in SpecDP while the Person feature of NE_{goal} is in the highest specifier of the intermediate layer. However, at some point in the derivation, these two features must interact, to the extent that the Reference of the NE is interpreted as having a relation to the Person of the possessor. I propose that this is obtained by covert movement of the Person features of the possessor to merge in a bundle with the Reference features of the possessed as in (23). In (24) the English counterpart is given, in which the possessor moves to SpecDP overtly:

(23) *le sue altre belle amiche italiane*

the of him / his other nice friends Italian

$[_{DP=NE} R_j[\#Fem, \#PI]+Person_i [_{D^\circ} le[iFem, iPI] [_{FP4} [_{AP} sue[Person_i, \#Fem, \#PI]]_i [_{F4^\circ} 0[AGREE, iFem, iPI]] [_{FP3} [_{AP} altre[\#Fem, \#PI]] [_{F3^\circ} 0[iFem, iPI]] [_{FP2} [_{AP} belle[\#Fem, \#PI]] [_{F2^\circ} amiche[iFem, iPI]] [_{FP1} [_{AP} italiane[\#Fem, \#PI] [_{F1^\circ} amiche[iFem, iPI]] [_{NP} [_{AP} sue]_i amiche[iFem, iPI]]]]]]]$

(24) *his other nice Italian friends*

$[_{DP=NE} R_j[\#PI]+[_{NE_{goal}} Person_i[his]] [_{D^\circ} 0[AGREE, iPI] [_{FP3} [_{AP} other[\#PI] [_{F^\circ 3} 0[iPI]] [_{FP2} [_{AP} nice[\#PI]] [_{F2^\circ} 0[iPI]] [_{FP1} [_{AP} Italian[\#PI]]_i [_{F^\circ 1} 0[iPI]] [_{NP} [_{NE_{goal}} his]_i] friends[iPI]]]]]]]$

Notice that the possessive adjective *sue* is at the same time agreeing and concurring with $F4^\circ$ in (23), while a pronoun *di lui* or *loro* would only Agree with the head, due to its own inflectional properties. This is the case of the personal pronoun *his* in (24), while it is probably not the case of possessive adjectives such as *my*, *your*, *our*, *their* which also concord (even if non-overtly) for the number feature of N in English.

The hierarchy of R features $NE > NE_{goal}$, namely $R_j > Person_i$ is respected at all levels in (23) and in (24) as the required by the *Universal Ordering Constraint* (15b). Overt Reference items such as demonstratives also come with uninterpretable features to be deleted against the interpretable copy in D. As a consequence, according to (16b), in a language like Italian they are in complementary distribution with an article. Notice that in this proposal nothing special is stipulated to capture the non-overt nature of an intermediate functional projection as opposed to the overt nature of D. In both cases the realization of a functional head is a last resort.

Cardinaletti and Giusti (to appear) present cases in which a functional head is realized if the modifiers merged in its specifier does not have an inflectional morphology that requires feature transfer. This is shown to hold in Italian for the demonstrative *quel*, for the partitive determiner *del* (all merged at the left edge) and also for the prenominal adjective *bel*, which is merged high in the intermediate layer. What is interesting is that in Anconetano, such functional dummies are subject to an particular phenomenon of optionality. In (25b-c) and (26b-c), either the higher or both heads are silent, with grammatical result, but if the silent option is chosen in the internal projection, the higher copy must also be silent, as shown by the ungrammaticality of (25d) and (26d):

- | | | | |
|------|--|------|---|
| (25) | a. <i>dei bei fioli</i>
b. <i>de bei fioli</i>
c. <i>de bè fioli</i>
d. * <i>dei bè fioli</i>
Part-art nice boys | (26) | a. <i>quei bei fioli</i>
b. <i>que bei fioli</i>
c. <i>que bè fioli</i>
d. * <i>quei bè fioli</i>
those nice boys |
|------|--|------|---|

These facts suggest on the one hand that Concord defines the (c)overt realization of the functional head in which it takes place; on the other hand, that projection is the locus of genuine optionality in feature realization, something to be carefully investigated in future research.

4. Conclusions

In this paper I made two major claims:

- (i) Feature sharing is the result of three different processes *Agreement*, *Concord*, and *Projection*.
- (ii) (ii) The features projected by nominal expressions are Gender, Number and Person. None of these features is associated to an EPP feature.

The first claim has a number of welcome consequences. First of all, it derives the tripartition observed in the structure of clauses and NEs and opens up the possibility of extending it to other lexical categories. It reduces the Agree relation (involving a probe targeting a goal) where it is independently motivated while dispensing with such an operation in the case of adjectival modification. It can also derive a number of differences

between different kinds of feature sharing. For example, Projection may give rise to genuine optionality of phonological merger (as claimed by Cardinaletti and Giusti (to appear)), and the two different relations of Agreement and Concord may be present in one and the same element, as is clear in possessive adjectives in Italian, which not only agree (they are the subject of the NE) but also display concord, parallel to other adjectives.

The second claim derives a number of well-known imperfect parallels between Nominal Expressions and Clauses such as those mentioned in (2). Lack of argument structure and of a SUBJECT position in NEs is directly related to the fact that NEs do not need to have a subject to be interpreted. Defectiveness of structural case assignment (only one genitive at most in the European languages), lack of pronominal clitics, of *wh*-features checking, and of most discourse related movements inside the NE are related to lack of an interpretable T feature in NE, which in the sentence is not only associated with EPP but is also bundled with Force and with Discourse features. Lack of subject raising, ECM complements, and other clausal transformations (Heageman and Guéron 1999:439-446) may also be derived by the assumption that multiple occurrences of AGREE must involve EPP features of the same kind, and the kind of EPP associated to T in the clause is different from the EPP which may be associated to the NE.

References

- Brugè, L. 1996. "Demonstrative movement in Spanish: A comparative approach". *University of Venice Working Papers in Linguistics* 6 (1): 1-53.
- Brugè, L. 2002. "The positions of demonstrative in the extended nominal projection". In *Functional structure in DP and IP. The cartography of syntactic structures*, vol.1, G. Cinque (ed.), 54-90. Oxford: Oxford University Press.
- Brugè, L. and G. Giusti. 1996. "On demonstratives". GLOW Talk. Athens.
- Campbell, R. 1996. "Specificity operators in SpecDP". *Studia Linguistica* 161-188.

- Cardinaletti, A. 1998. "On the deficient/strong opposition in possessive systems". In *Possessors, Predicates and Movement in the Determiner Phrase*. A. Alexiadou and Ch. Wilder (eds.), 17-53. Amsterdam: Benjamins.
- Cardinaletti, A. and G. Giusti. To appear. "L'opzionalità alle interfacce sintassi-morfologia-fonologia". Atti SLI 2009.
- Carstens, V. 2001. "Multiple Agreement and Case-Deletion: Against φ -(In)Completeness". *Syntax* 4: 147-163.
- Chomsky, N. 1995. *The Minimalist program*. Cambridge MA: MIT Press.
- Chomsky, N. 2005. "Three factors in language design". *Linguistic Inquiry* 36 (1): 1-22.
- Cinque, G. 1994. "On the evidence for partial N-movement in the Romance DP". In *Paths towards universal grammar*, G. Cinque et al. (eds.), 85-110. Washington DC: Georgetown University Press.
- Cinque, G. 1999. *Adverbs and Functional Heads*. Oxford: Oxford University Press.
- Cornilescu, A. 1995. "Romanian Genitive Constructions". In *Advances in Roumanian Linguistics*, G. Cinque, and G. Giusti (eds.), 1-54. Amsterdam: Benjamins.
- Dobrovie-Sorin, C. 2000. "(In)definiteness spread: from Romanian genitives to Hebrew construct state nominals". In *Comparative studies in Romanian Syntax* [North-Holland Linguistic Series 58], V. Motapanyane, (ed.), 177-193. Elsevier: Amsterdam.
- Giorgi, A. and F. Pianesi. 1997. *Tense and Aspect. From Semantics to Morpho-Syntax*. Oxford: Oxford University Press.
- Giusti, G. 1996. "Is there a TopP and a FocP in the Noun Phrase?" *University of Venice Working Papers in Linguistics* 6: 105-128.
- Giusti, G. 1997. "The categorial status of determiners". In *The New Comparative Syntax*, L. Haegeman, (ed.), 95-123. London: Longman.
- Giusti, G. 2002. "The functional structure of noun phrases: A bare phrase structure approach". In *Functional structure in DP and IP: The cartography of syntactic structures, vol 1*, G. Cinque (ed.), 54-90. Oxford: Oxford University Press.
- Giusti, G. 2008. *Agreement and Concord in Nominal Expressions*, In *The Bantu-Romance Connection*. C. De Cat & K. Demuth (eds.), 201-237. Amsterdam: Benjamins.
- Hornstein, N., J. Nunes and K. Grohman. 2005. *Understanding Minimalism*. Cambridge Textbook in Linguistics. Cambridge: CUP.
- Grimshaw, J. 1991. "Extended projections". Ms. Brandeis.
- Haegeman, L. & J. Guéron. 1999. *English Grammar*. London: Blackwell.

- Matushansky, O. 2006. "Head movement in linguistic theory". *Linguistic Inquiry* 37 (1): 69-109.
- Pesetsky, D. and E. Torrego. 2001. "T-to-C movement". In *Ken Hale: a Life in Language*. Michael Kenstowicz (ed.). Cambridge MA: MIT Press.
- Rizzi, L. 1997. "The fine structure of the left periphery". In *Elements of Grammar*, L. Haegeman (ed.), 281-337. Dordrecht: Kluwer.
- Szabolcsi, A. 1987. "The possessor that ran away from home". *The Linguistic Review* 3: 89-102. 1983/84.
- Szabolcsi, A. 1994. "The noun phrase". In *The structure of Hungarian*. F. Kiefer and K. É. Kiss (eds.), 179-274. San Diego: Academic Press.

Towards a Hierarchy of Clause Types

Nicola Munaro
University of Venice

0. Introduction

As is well known, a considerable number of North-Eastern Italian dialects display the morphosyntactic phenomenon traditionally defined as *interrogative inversion*: it consists in the encliticization of a pronominal subject onto the inflected verb.

In this article, I will try to determine the range of possible interpretations which can be associated with sentences whose predicate has the relevant verbal features. The analysis will turn out to shed light on the hierarchical articulation of the left periphery.¹

¹. The leading ideas underlying the present article were first expressed in the second chapter of my PhD thesis (Munaro (1997)). Previous and partial versions of the issues addressed here have been presented at the conference *I confini del dialetto* (Sappada (BI), July 2000), at *Going Romance 2000* (Utrecht, December 2000) at the *IV International LEHIA Workshop* (Vitoria-Gasteiz, June 2001), at the *XXV GLOW Colloquium* (Amsterdam, April 2002), at the *Ottava Giornata di Dialettologia* (Padua, July 2002), at the *Language, Brain and Computation* conference (Venice, October 2002). I thank the audiences of these events for helpful remarks. This article is essentially an updated and revised version of some of the issues dealt with in Munaro (2001), (2002) and (2005). Thanks are due to Paola Benincà, Guglielmo Cinque and Mario D'Angelo for extensive discussion and insightful suggestions on many aspects of the analysis; I also benefitted from discussions with Josef Bayer, Anna Cardinaletti, Liliane Haegeman and Cecilia Poletto and from the comments of anonymous reviewers on earlier versions of this work. The usual disclaimers apply. I would like to thank P. Benincà and the Friulian team of PhD students for patiently providing the Paduan and Friulian data and the native speakers for providing me with the relevant judgements about the data of the Veneto varieties and standard French. I'd like to dedicate this

Within the relatively recent line of research adopting a split-CP approach (see Rizzi (1997) and Benincà (2001) among many others), it will be proposed that the presence of subject clitic inversion is the reflex of a syntactic process; more precisely, that it entails raising of the inflected verb to one of the functional projections of the CP-field which are argued to encode different aspects of the speaker's representation of the propositional content expressed.

The article is organized as follows: in section 1 the existence of an independent series of enclitic subject pronouns is briefly argued for and the possible contexts of use of non-assertive subject clitics in Friulian are presented. Section 2 is devoted to identify the crossdialectal variation attested in some Veneto dialects with respect to the range of the interpretive implications associated with inversion. In section 3 I sketch an analysis of the ordering restriction constraining the relative order of protasis and apodosis when the former displays inversion between subject and inflected verb, on the basis of data from standard Italian and some North-Eastern Italian dialects. I will thereby try to account for the fact that conditional clauses containing inversion must precede the main clause, speculating in section 4 on the possible landing site of preposed adjunct conditional clauses in a split left periphery. In section 5 I provide a finer semantic characterization of the relevant functional projections making up the upper portion of sentence structure, discussing their relative hierarchical ordering. Section 6 concludes the paper with a few summarizing remarks.

1. The enclitic paradigm of subject pronouns

1.1. Two independent paradigms

This section addresses the question of the status of the subject pronouns showing up in inversion contexts. In many North-Eastern Italian dialects, the verbal conjugation displays a different agreement paradigm in assertive and in interrogative clauses; the assertive and interrogative inflectional paradigms of the present indicative of Paduan and Agordino (a Central and a Northern Veneto variety) are reported in (1) and (2) respectively:

paper to the memory of my father, whose outstanding moral legacy is still a lighthouse to me in the troubled sea of everyday life.

- | | | | | |
|-----|----|-----------------------|----|-------------------------|
| (1) | a. | 1. magno | b. | 1. magno(<i>i</i>) |
| | | 2. <i>te</i> magni | | 2. magni- <i>to</i> |
| | | 3. <i>el/la</i> magna | | 3. magne- <i>lo/la</i> |
| | | 4. magnemo | | 4. magnémo-(<i>i</i>) |
| | | 5. magnè | | 5. magnè- <i>o</i> |
| | | 6. <i>i/le</i> magna | | 6. magne- <i>li/le</i> |
| | | | | |
| (2) | a. | 1. varde | b. | 1. varde |
| | | 2. <i>te</i> varde | | 2. varde- <i>to</i> |
| | | 3. <i>el/la</i> varda | | 3. varde- <i>lo/la</i> |
| | | 4. vardon | | 4. vardon- <i>e</i> |
| | | 5. vardé | | 5. vardé- <i>o</i> |
| | | 6. <i>i/le</i> varda | | 6. varde- <i>li/le</i> |

As one can easily see, the proclitic subject pronouns appearing in the assertive paradigms in (1a) and (2a) differ from the enclitic ones of (1b) and (2b) both in number and in form; notice, however, that the verbal form remains unchanged.²

In Renzi & Vanelli (1983), one of the earliest investigations of subject clitics in the Northern Italian domain, the authors formulate the two following descriptive generalizations: (a) if a variety forms interrogatives through the inversion of the pronoun, then the number of the persons constantly displaying a pronoun is the same or superior with respect to the number of persons with pronoun in assertive contexts; (b) in most cases the enclitic pronoun of interrogatives is different from the proclitic one appearing in assertives in the corresponding person. On the basis of these two arguments, the paradigm of subject clitics appearing in interrogative contexts is regarded as largely independent from the one appearing in assertive contexts.

Moreover, as pointed out by Poletto (1993), in some Northern Italian varieties a proclitic subject can cooccur with an enclitic one, as exemplified in (3a) with the Piedmontese variety of Turin and in (3b) with Western Friulian:

- | | | | | |
|-----|----|--------------------------------|----|---------------------------------|
| (3) | a. | lon ch' a l' a-lo fait? | b. | cui a compri- <i>al</i> il pan? |
| | | what that scl-scl-has-scl done | | who scl-buys-scl the bread? |
| | | 'what has he done?' | | 'who buys the bread?' |

². Only some functional verb forms are affected, as for example in Paduan the second person singular of the verb '*want*' *te voi* becomes *vuto* in the interrogative form.

In (3a), unlike in (3b), the inflected verb (with the enclitic pronominal subject *lo*) is preceded not only by the vocalic subject clitic *a*, but also by the agreement proclitic morpheme *l*.

Furthermore, if a dialect displays an enclitic series of pronominal subjects, these must be obligatorily used in main interrogatives, as shown by the contrast in grammaticality between (4a) and (4b) in Friulian:

- | | | |
|-----|--|---|
| (4) | a. <i>ce fas-tu?</i>
what (scl) do
'what are you doing?' | b. <i>*ce (tu) fas?</i>
what do-scl
'what are you doing?' |
|-----|--|---|

Interestingly, the occurrence of the enclitic series of pronominal subjects seems to be limited to the structures in which the inflected verb raises higher than the agreement field, that is, in main contexts where the head C° is free, as in (4a), but not in embedded interrogatives, where that position is presumably occupied by the complementizer *che*, as witnessed by the contrast between (5a) and (5b) in Bellunese:

- | | | |
|-----|---|--|
| (5) | a. <i>no so cossa che l' à comprà</i>
not know what that scl-has bought
'I don't know what he has bought' | b. <i>*no so cossa che à-lo comprà</i>
not know what that has-scl bought
'I don't know what he has bought' |
|-----|---|--|

In light of these data, the following will be adopted as a diagnostic paradigm to discriminate between a proclitic and an enclitic series of subject pronouns:³

- | | |
|-----|--|
| (6) | a. different number of persons in the verbal paradigm displaying pro- vs enclitic pronouns |
| | b. (partially) different morphological shape of pro- vs enclitic pronouns |
| | c. possibility of cooccurrence in some varieties |

³. A slightly different version of (6) is proposed by Poletto (2000), who claims that subject clitic inversion implies raising of the inflected verb to a (low) position of the CP-layer, basing her assumption on arguments from various Northern Italian dialects; she also analyzes the role of subject clitic inversion in optative, counterfactual and disjunctive clauses with respect to complementizer deletion phenomena, showing that, at least in some cases, an analysis in terms of verb raising to the C-domain is viable.

The data discussed in this section suggest that enclitic pronominal subjects should be distinguished from proclitic ones and, more precisely, be analyzed as bound morphemes selecting the inflected verb: I will assume that the verbal form displaying encliticization of the subject pronoun is realized through left-adjunction of the verb to the clitic. Furthermore, I propose that the structural position inside which the finite verb merges with the enclitic subject is a relatively high functional head of the functional architecture of the clausal structure that will be identified more precisely below.⁴

1.2. The contexts of use of enclitic subject pronouns: subject clitic inversion in Friulian

On the basis of a wide crosslinguistic survey, Sadock & Zwicky (1985) identify three basic sentence types that seem to be present in most languages: *declaratives*, *interrogatives* and *imperatives*; interestingly, the syntactic distribution of clitic subject pronouns with respect to the inflected verb varies depending on the three basic sentence types; the subject clitic precedes the verb in declarative clauses, follows the inflected verb in interrogative clauses, and is missing in imperative clauses, as exemplified in (7a-c) with Bellunese respectively:

- | | | | |
|-----|--------------------|--------------------|------------------|
| (7) | a. <i>te magna</i> | b. <i>magnetu?</i> | c. <i>magna!</i> |
| | ‘you are eating’ | ‘are you eating?’ | ‘eat!’ |

⁴. In Munaro (1997) I located this position at the edge of IP (that is, at the border between the inflectional and the complementizer layer of the extended functional structure of the sentence) and labelled it *Type*^o to express the fact that it is crucially involved in the determination of the sentential type (as will become clear from the data discussed in section 2). The head position inside which the subject clitic merges with the inflected verb is identified with *IntForce*^o in Munaro, Poletto & Pollock (1998), *AgrC*^o in Poletto (2000), *AgrS*^o in Hulk (1993).

Note that the discussion of the interpretive values expressible by subject clitic inversion developed in the following sections is compatible with an approach analyzing the subject pronoun as a maximal projection first merged in [spec,IP] and viewing inversion as the result of (remnant) phrasal movement, such as the one proposed by Pollock (2000) and subsequently adopted by Poletto & Pollock (2004) and Munaro & Pollock (2005); for ease of exposition, though, I will adopt an analysis in terms of head movement of the verbal head.

These distributional properties can be interpreted as indicating that *enclitic subject pronouns can have the function of marking a specific class of clause types, exactly as particles do in other languages*⁵. In the remainder of this section I will further develop this intuition.

The encliticization of the pronominal subject to the inflected verb has been labelled *interrogative inversion* in the descriptive literature on the topic, as it obtains primarily in main interrogative clauses – as witnessed by (7b). However, in the North-Eastern Italian dialects displaying this morphosyntactic phenomenon, it is by no means limited to interrogatives, but is attested in a wide variety of syntactic contexts, suggesting that the template with enclisis in (7b) covers in fact a wide range of clause types, among which the interrogative one is simply the most frequently attested in a crosslinguistic perspective.

These contexts have been described by Benincà (1989) in her analysis of central Friulian; the different instances of subject clitic inversion include the cases listed here and exemplified with Friulian:

- main interrogative sentences, including both *wh*-questions focussing on a constituent (8a) and *yes/no* questions (8b):

- | | |
|---|--|
| (8) a. cui vegni- <i>al</i> ?
who comes-scl
'who's coming?' | b. vegni- <i>al</i> Toni?
comes-scl Toni
'is Toni coming?' |
|---|--|

- sentences structurally resembling interrogatives but having the pragmatic force of exclamatives, through which the speaker expresses an emotionally salient attitude; (9) expresses the speaker's dismay for what he's forced to see:

- (9) ce mi toci-*al* di vjodi!
what me must-scl of see
'what I'm forced to see!'

- sentences where inversion is preceded by a negation, expressing the speaker's negative presupposition with respect to the propositional content, which is presented as

⁵. This idea was expressed in Munaro (1997). Among minor clause types the most frequently found – according to Sadock & Zwicky (1985)– are *exclamatives* and *optatives*.

- disjunctive structures with a concessive interpretation in which two alternative possibilities are taken into account and evaluated as irrelevant to the realization of the event expressed by the main sentence; in (13) the speaker evaluates the subject's financial condition as irrelevant:

- (13) *sedi-al pùar o sedi-al sior, no m' impuarte*⁷
 be-scl poor or be-scl rich, not to-me matters
 'whether he's rich or poor, I do not care'

On the whole, *the contexts exemplified here are non-veridical as they convey a subjective (re)presentation of the propositional content; they are characterized by the fact that the speaker takes a particular stance with respect to the propositional content expressed, in the sense that the event is not presented objectively, as a matter of fact, like in assertive contexts, but subjectively, that is somehow related to the speaker's particular observational perspective.*⁸

⁷. In (13) the disjunctive clause involves two auxiliary verbs, but the disjunction of two lexical verbs is equally well-formed:

- (i) *veni-al o no veni-al, o prepari instèss*
 comes-scl or not comes-scl, scl-prepare the-same
 'whether he comes or not, I prepare in any case'

⁸. As a final descriptive remark, let me point out that - at a relatively high stylistic level - inversion between auxiliary and nominal subject is grammatical in standard Italian in the same syntactic contexts, as witnessed by (i):

- (i) a. *Avrebbe Gianni potuto aiutarci?*
 'Could John have helped us?'
 b. *Quanti libri è Gianni riuscito a leggere!*
 'How many books John has succeeded in reading!'
 c. *Fosse Gianni arrivato in tempo!*
 'Had John arrived in time?'
 d. *Fosse Gianni arrivato in tempo, tutto questo non sarebbe successo*
 'Had John arrived in time, all this would not have happened'
 e. *Fosse Gianni arrivato in tempo o meno, saremmo partiti in ogni caso*
 'Had John arrived in time or not, we would have left in any case'

2. The range of crosslinguistic variation

In this section I will carry out a comparative survey of the crossdialectal variation detectable among some Venetan varieties with respect to the possible interpretations which can be associated with enclisis of the pronominal subject onto the inflected verb.⁹

In all of these cases, inversion between nominal subject and inflected auxiliary is in complementary distribution with an overt complementizer – *che* or *se* – followed by a preverbal subject:

- (ii) a. *Se* Gianni avrebbe potuto aiutarci? [uttered as an echo question to (ia)]
 ‘If John could have helped us?’
 b. Quanti libri *che* è riuscito a leggere Gianni!
 ‘How many books [that] John has succeeded in reading!’
 c. *Se* Gianni fosse arrivato in tempo!
 ‘If only John had arrived in time!’
 d. *Se* Gianni fosse arrivato in tempo, tutto questo non sarebbe successo.
 ‘If John had arrived in time, all this would not have happened’
 e. *Che* Gianni fosse arrivato in tempo o meno, saremmo partiti in ogni caso.
 ‘Whether John had arrived in time or not, we would have left in any case’

(Some of) the instances of inversion listed in (i) have been analyzed by Rizzi (1982) in terms of raising of the auxiliary verb to Comp°. In the same vein, Poletto (2000) analyzes subject-clitic inversion in these cases as a consequence of verb raising to (a low head position of) the CP field to check a [-realis] feature, thereby inhibiting the realization of the complementizer.

On the hypothesis that the enclitic subject pronoun is generated within a functional head of the CP field see also Munaro, Poletto & Pollock (2001).

⁹. Let me mention, just for the sake of completeness, that the pattern of central Friulian described in the previous section is also attested in the Venetan variety spoken in country hinterland of Venice, where inversion (which is fully productive only in the third person singular) seems to be compatible with all the relevant readings:

- (i) a. *vegna-lo?* a’. *cossa magne-lo?*
 b. *quanti libri no ga-lo leto?!*
 c. *no ga-lo magnà tuto!*
 d. *rivasse-lo in tempo, almanco!*
 e. *fusse-lo vegnùo anca Mario, gavaressimo podùo dirghelo*
 f. *magne-lo o no magne-lo, mi preparo lo stesso*

- f. *magne-*lo* o no magne-*lo*, mi parécio istéssso
 eats-scl or not eats-scl, I prepare the same
 ‘whether he eats or not, I prepare in any case’

A different distributional pattern is found in the central Veneto variety spoken in Carmignano di Brenta (situated between Padua and Vicenza), where inversion is not accepted in hypothetical and disjunctive concessive contexts, but is in optatives, exclamatives and interrogatives:

- (15) a. vignì-o? a’. cossa magni-to?
 b. quanti libri (no) ga-lo leto?!
 c. no ga-lo magnà tuto!
 d. rivàsse-lo in tempo, ‘na volta!¹¹
 e. *fusse-lo vignùo anca Mario, gavarìssimo podùo dirghelo
 f. *magne-*lo* o no magne-*lo*, mi parècio istéssso

Still different is the distribution attested in the dialect of Illasi (spoken in the Western Veneto province of Verona), where the presence of subject clitic inversion gives rise to ungrammatical outcomes in optative, hypothetical and disjunctive concessive structures, as shown in (18):

- (16) a. ven-*lo*? a’. sa magne-*lo*?
 b. quanti libri no à-*lo* leto?!
 c. no a-*lo* magnà tuto!
 d. *rivésse-*lo* in tempo!
 e. *fosse-*lo* vegnù anca Mario, avaressimo podù dirghelo
 f. *magne-*lo* o no magne-*lo* mia, mi preparo istéssso

This brief comparison among some of the North-Eastern Italian dialects displaying subject clitic inversion reveals a remarkable range of crosslinguistic variation in the set

¹¹. According to my informant, in order to obtain full acceptability, the optative structure exemplified in (17d) requires the addition of some lexical material at the end of the clause, such as the adverbial ‘*na volta*’ (‘for once’).

of possible interpretations associated with structures displaying the enclisis of the pronominal subject.¹²

2.2. Splitting up the host: the two subfields

Let us now try to outline our findings more precisely: in Friulian subject clitic inversion displays the whole set of readings, Paduan lacks only the disjunctive concessive reading, the dialect of Carmignano lacks the hypothetical and the disjunctive reading, while the dialect of Illasi lacks the optative, the hypothetical and the disjunctive reading. The pattern of variation resulting from the data is summarized in the following synoptic chart:

¹². Notice that in the variety of Pieve d'Alpago (spoken in the Northern Veneto province of Belluno), we find a somewhat puzzling pattern, as inversion is compatible with the disjunctive, the exclamative and the interrogative reading, but not with the optative and the hypothetical one, as shown by the ungrammaticality of (id-e):

- | | |
|--|---------------------------|
| (i) a. vien- <i>lo</i> ? | a'. magne- <i>lo</i> che? |
| b. quanti libri no à- <i>lo</i> ledést?! | |
| c. no à- <i>lo</i> magnà tut! | |
| d. *rivésse- <i>lo</i> in temp! | |
| e. *füsse- <i>lo</i> vegnést anca Mario, se avaria podést dirghelo | |
| f. màgne- <i>lo</i> o no màgne- <i>lo</i> , mi parècie instéss | |

It is noteworthy that in this dialect an example corresponding to (13) above, where the pronominal subject encliticizes onto a subjunctive form of the verb *èser*, is ungrammatical, as shown in (iia); however, this does not seem to depend on the use of an auxiliary verb, as shown by the grammaticality of (ib) where an indicative form is used:

- | | |
|---|---|
| (ii) a. *sie- <i>lo</i> sior o sie- <i>lo</i> puarét, no me intarèsa
be-scl rich or be-scl poor, not me interests
'I don't care whether he is rich or poor' | b. é- <i>lo</i> sior (o) é- <i>lo</i> puarét, no me intarèsa
is-scl rich (or) is-scl poor, not me interests
'I don't care whether he is rich or poor' |
|---|---|

The ungrammaticality of (iia) should probably be attributed to an incompatibility of the enclitic subject with the subjunctive mood.

(17)

	<i>Central Friulian</i>	<i>Central-Southern Veneto</i>	<i>Central-Western Veneto</i>	<i>Western Veneto</i>
interrogatives	+	+	+	+
pseudo-questions	+	+	+	+
presuppositional exclamatives	+	+	+	+
optatives	+	+	+	-
<i>if</i> -clauses	+	+	-	-
disjunctive concessives	+	-	-	-

As can easily be observed, what we find across the dialects considered is not a random variation, as inversion is invariably associated to interrogative, pseudo-interrogative and exclamative contexts; whenever a given variety lacks some instances of inversion, the missing cases always belong to the subset including optative, hypothetical or disjunctive contexts.

A straightforward account of the particular distribution of subject clitic inversion observed above relies on the assumption that the inflected verb with enclisis of the pronominal subject can occupy more than one structural position, that is, that the attested crossdialectal variation depends on verb raising to different functional heads of the upper portion of the clausal skeleton, as a result of the incremental loss of verb movement.

More precisely, the fact that inversion is invariably compatible with the interrogative and exclamative readings provides evidence for a first splitting into two subfields, as shown in (18):

(18) *Concessive-Hypothetical-Optative* > *Presuppositional-Exclamative-Interrogative*

On the other hand, the relevant contexts listed in (8)-(13) can be split in a different way according to whether we have to do with a monoclausal or with a biclausal structure; (8)-(11) are monoclausal structures in which the enclitic subject merges with the inflected part of the main predicate; (12)-(13) are biclausal structures in which subject clitic inversion obtains inside the adjunct clause which functions are circumstantial

- e. (Marie) viendrait-*elle* que je serais surpris
 (Mary) would-come-scl that I would-be surprised
 ‘if Mary/she came I would be surprised’
- f. ???viendrait-*il* ou ne viendrait-*il* pas je partirai de toute façon
 would-come-scl or neg would-come-scl not I will-leave of all way
 ‘whether he comes or not, I’m going to leave in any case’

The distributional pattern found in standard French is the same as the one displayed in Paduan and is compatible with the variation range resulting from (17): as witnessed by the marginality of (21f) the only structure incompatible with inversion is the disjunctive concessive one. The example in (21f) has a grammatical counterpart in which the subject clitic appears in preverbal position and the two members of the disjunction are introduced by the complementizer *que*.¹³

¹³. In the instance of subject clitic inversion exemplified in (21c) the cluster *-t-il pas* is enclitic on the defective verbal form *voilà*, as witnessed again by (i):

- (i) ...ne voilà-*t-il* pas que le loup revient
 neg seethere-scl not that the wolf comes back
 ‘...and here the wolf returns’

The range of presuppositional implications expressed by the construction with *tu-pas* attested in Quebec French has been examined by Vinet (1998); more recently, Vinet (2000) has sketched an analysis of *tu(pas)* in terms of feature composition: *-tu* is analyzed as a Force operator identified in the CP domain at LF licensing certain types of illocutionary force structures with a finite tense; she also points out that some of the features of *-tu* as a mood force indicator can also be found with the *-t-il* form and its variants in standard French. According to Roberts (1993a), *tu* in *tu-pas* can be analyzed as a phonological variant of *t-il* in standard French (or *ti* in many varieties of colloquial French); furthermore, Roberts (1993b) claims that in some dialects of contemporary Valdotain postverbal subject pronouns are developing into *ti*-morphemes and that this phenomenon is a consequence of the loss of inversion in interrogatives; if his hypothesis is correct, it looks plausible to relate structures like (i) to erstwhile inversion structures where the verb used to raise to the relevant head position.

3. On the distribution of conditional and concessive clauses

In this section I present some evidence suggesting that the main clause must follow the associated adjunct - conditional or concessive - clause whenever inversion between the subject and the inflected verb obtains inside the latter.

As anticipated above - and proposed in recent work of mine (Munaro (2002), (2005)) - I analyze the presence of subject (clitic) inversion inside the adjunct clause as resulting from the raising of the inflected verb to some head position of the CP field; as will become clearer below, I take verb raising inside the adjunct clause to target an appropriate C° head in order to satisfy a clausal typing requirement.

3.1. Ordering restrictions on conditionals

In discussing the distributional properties of adjunct conditional clauses with respect to the main clause, in light of the data presented in the previous section, I will introduce a distinction between conditionals with an optative flavour, mostly containing a compound tense, where the speaker emphasizes his regret for the fact that a given situation did not take place, and standard counterfactual conditionals, where the unrealized condition expressed by the protasis is presented by the speaker more objectively, and can therefore be expressed by a simple tense.

3.1.1. Optative conditionals

In some North-Eastern Italian varieties, among which Friulian, the protasis can convey an optative reading expressing the speaker's regret for an unfulfilled condition, which is emphasized by the use of the exclamation mark; in this case there seems to be a rather rigid ordering restriction between the main clause and an optative conditional clause:

- (22) a. Vèss-jo korùt, no varès pjerdùt il treno in ke olte!
 b. *No varès pjerdùt il treno in ke olte, vèss-jo korùt!
 [Had-scl run] not would-have missed the train in that time [had-scl run]
 ‘[I wish I had run], I would not have missed the train on that occasion, [I wish I had run]!’

- (23) a. Foss-jo lât, al sarès stât dut plui bièl!
 b. *Al sarès stât dut plui bièl, foss-jo lât!
 [Were-scl gone] scl-would have been all more beautiful [were-scl gone]
 ‘[I wish I had gone], everything would have been better, [I wish I had gone]!’
- (24) a. Vèss-jo volùt studià, o varès podùt fa il profesor!
 b. *O varès podùt fa il profesor, vèss-jo volùt studià!
 [Had-scl wanted to study] scl-could have done the professor [had-scl wanted to study]
 ‘[I wish I had felt like studying] I could have become a professor [I wish I had felt like studying]!’

The adjunct clause expressing the speaker's unfulfilled wish and containing subject clitic inversion must precede the main clause in order to guarantee a grammatical outcome.

3.1.2. Counterfactual conditionals

More generally, the protasis of a conditional cluster expresses the unrealized condition under which the event expressed by the main clause might take or might have taken place.

In a North-Eastern Italian dialect like Paduan a conditional clause expressing a counterfactual entailment can either precede or follow the main clause if it is introduced by the complementizer *se*:

- (25) a. Garissimo podùo dirghelo, se el fusse vignù
 Could have told-him-it, if scl-were come
 ‘We could have told him, if he had come’
 b. Se el fusse vignù, garissimo podùo dirghelo
 If scl-were come, could have told-him-it
 ‘If he had come, we could have told him’

The contrast between (26a) and (26b) clearly indicates that, unlike what happens in *if*-conditionals (where the relative order of main and embedded clause is irrelevant), the conditional embedded clause containing inversion has to precede the main clause:

- (26) a. *Garissimo podùo dirghelo, fùsse-*lo* vignù
 Could have told-him-it, were-scl come
 ‘We could have told him, had he come’
 b. Füsse-*lo* vignù, garissimo podùo dirghelo
 Were-scl come, we could have told-him-it
 ‘Had he come, we could have told him’

As is clear comparing (25) and (26), the subordinating complementizer *se* introducing the conditional clause is in this case in complementary distribution with subject clitic inversion; this suggests that in structures like (26b) raising of the inflected verb inside the adjunct clause inhibits the realization of *se* in the same head (and triggers raising of the whole embedded clause across the main clause).

The same ordering restriction between main clause and conditional adjunct clause is attested in standard Italian:

- (27) a. Saremmo potuti uscire, se tua sorella fosse arrivata in tempo
 ‘We could have gone out, if your sister had arrived in time’
 b. Se tua sorella fosse arrivata in tempo, saremmo potuti uscire
 ‘If your sister had arrived in time, we could have gone out’
 (28) a. *Saremmo potuti uscire, fosse tua sorella arrivata in tempo
 ‘We could have gone out, had your sister arrived in time’
 b. Fosse tua sorella arrivata in tempo, saremmo potuti uscire
 ‘Had your sister arrived in time, we could have gone out’

Again, whenever verb raising obtains inside the adjunct clause - witnessed in (28) by inversion between subject and auxiliary and by the absence of the subordinating complementizer - the conditional clause obligatorily precedes the main clause.

3.2. Ordering restrictions on concessive conditionals

Similar conditions seem to constrain the relative order of a main clause with respect to an associated adjunct clause with a concessive reading. In this case too I will deal separately with two types of concessives, namely ordinary concessive clauses, expressing a condition whose realization is evaluated as irrelevant to the realization of

the propositional content expressed by the main clause, and alternative concessive conditional clauses, where two alternative and – with respect to truth value- opposite eventualities are taken into account and judged irrelevant for the event expressed by the main clause.

3.2.1. Ordinary concessives

In addition to the readings listed in section 1.2 above, subject clitic inversion can also occur –for example in Paduan– in adjunct clauses with a concessive value, provided that the inflected verb is either preceded or followed by *anca*:¹⁴

- (29) a. *Anca gavesselo telefonà, cossa garissimo podùo dirghe?*
 b. *Gavesselo anca telefonà, cossa garissimo podùo dirghe?*
 ‘[Even] had-he [even] phoned, what could we have told him?’

Alternatively, the concessive adjunct can be introduced by *anca ben*, which however, unlike simple *anca*, cannot follow the inflected verb with inversion:¹⁵

- (30) a. *Anca ben vegnisselo, cossa podarissimo dirghe?*
 b. **Vegnisselo anca ben, cossa podarissimo dirghe?*
 ‘[Even if] came-he, what could we tell him?’

As observed above, the concessive adjunct containing inversion cannot follow the main clause:

- (31) a. **Cossa garissimo podùo dirghe, anca gavesselo telefonà?*
 b. **Cossa garissimo podùo dirghe, gavesselo anca telefonà?*
 ‘What could we have told him,[even] had-he [even] phoned?’

¹⁴. Note that while the adjunct clause of (29a) is only interpretable as a concessive, in (29b) it is ambiguous, as *anca* is amenable to an interpretation as intensifier, so that in this case the interpretation of the adjunct clause can be something like *if he had also phoned (beside writing)*...

¹⁵. On the possibility for *ben* to develop a concessive reading across Romance, see Hernànz (this volume).

- (32) *Cossa podarissimo dirghe, anca ben vegnisselo?
 ‘What could we tell him, [even if] came-he?’

No such restriction is attested when the concessive adjunct is introduced by *anca se*, and no subject clitic inversion obtains:

- (33) a. Cossa garissimo podùo dirghe, anca se el gavesse telefonà?
 ‘What could we have told him, even if he had phoned?’
 b. Anca se el gavesse telefonà, cossa garissimo podùo dirghe?
 ‘Even if he had phoned, what could we have told him?’

3.2.2. Alternative concessive conditionals

The two alternatives expressed by a concessive conditional adjunct are evaluated by the speaker as irrelevant for the realization of the propositional content expressed by the main clause.

As witnessed by the contrast between (34) and (35) in Friulian, the relative order of main clause and adjunct clause is immaterial whenever the subordinating complementizer is overtly realized, while in the presence of subject inversion the first position of the adjunct clause is mandatory:¹⁶

¹⁶. The same restriction holds for the disjunctive structure from Northern Veneto reported in (if) in footnote 12, and expressing an alternative concessive conditional reading:

- (i) a. Mâgne-*lo* o no mâgne-*lo*, mi parècie instéss
 b. *Mi parècie instéss, mâgne-*lo* o no mâgne-*lo*
 ‘Whether he comes or not, I prepare in any case’

Interestingly, the same dialect displays mandatory preposing of disjunctive embedded *yes/no* questions with inversion:

- (ii) a. No so dirte se’l gnen o se no’l gnen
 Not know tell-you whether scl-comes or whether not scl-comes
 ‘I can’t tell you whether he comes or not’
 b. Gnenlo (o) no gnenlo, no so dirte
 Comes-scl (or) not comes-scl, not know tell-you
 ‘Whether he comes or not, I can’t tell you’
 b’. *No so dirte, gnenlo o no gnenlo
 Not know tell-you, comes-scl or not
 comes-scl
 ‘I can’t tell you whether he comes or not’

- (34) a. C'al sedi rivat o ca no'l sedi rivàt, jo o voi vie istés
 b. Jo o voi vie istés, c'al sedi rivat o ca no'l sedi rivàt
 [That scl-be arrived or that not-scl-be arrived] I scl-go away the same [that scl-be arrived or that not-scl-be arrived]
 'Whether he has arrived or not] I'm going in any case [whether he has arrived or not]'
- (35) a. Sedi-al rivàt o no sedi-al rivàt, jo o voi vie istés
 b. ??Jo o voi vie, sédi-al rivàt o no sédi-al rivàt
 [Be-scl arrived or not be-scl arrived] I scl-go away the same [be-scl arrived or not be-scl arrived]
 'Whether he has arrived or not] I'm going in any case [whether he has arrived or not]'

Once more, standard Italian confirms the relevant restriction:

- (36) a. Che tua sorella fosse venuta o meno/non fosse venuta, noi saremmo andati lo stesso
 'Whether your sister had come or not, we would have gone in any case'
 b. Noi saremmo andati (lo stesso), che tua sorella fosse venuta o meno/non fosse venuta
 'We would have gone (in any case), whether your sister had come or not'
- (37) a. Fosse tua sorella venuta o meno, noi saremmo andati lo stesso
 'Whether your sister had come or not, we would have gone in any case'
 b. ??Noi saremmo andati (lo stesso), fosse tua sorella venuta o meno
 'We would have gone (in any case), whether your sister had come or not'

Summing up, the relative order of the main clause and an adjunct (conditional or concessive) clause is irrelevant when the latter is introduced by a complementizer, while the main clause must follow the adjunct clause whenever this displays inversion between the subject and the inflected verb. In other words, verb raising to the CP field inside the adjunct clause, producing subject inversion, induces a rigid order between the

It is not implausible that the fronting of the embedded interrogative targets the specifier of the projection *Int(errogative)P* argued for by Rizzi (2001a).

two clauses. In the following section I will explore the possibility that the observed restriction on the linear order of the two clauses results from the compulsory fronting of the adjunct clause to a dedicated specifier of the left periphery of the main clause. The hypothesis that the attested order is produced by preposing the adjunct clause relies on the tacit assumption that in the basic order the main clause precedes the adjunct; empirical evidence that this is indeed the case is provided by Haegeman (2002), who develops a detailed analysis of the difference between event conditionals and premise conditionals.¹⁷

3.3. On the trigger of adjunct clause preposing

3.3.1. Preposed conditional adjuncts as clausal topics

The informational status of an *if*-clause with respect to its topic-focus nature plays a role in determining the respective order of the two clauses.¹⁸

¹⁷. The two types of conditional clauses are exemplified in (ia) and (ib):

- (i) a. If it rains we will all get terribly wet and miserable
 b. If - as you say - it is going to rain this afternoon, why don't we just stay at home?

Haegeman (2002, this volume) proposes that event conditionals are more closely integrated with the associated clause than premise conditionals on the basis of scope effects induced by scope bearing elements in the associated clause (such as tense, epistemic modality, adverbials, focus and quantifiers/bound pronouns); in particular, she argues that the structural integration of the former in the domain of the associated clause depends on their being generated in a position (right-)adjoined to the matrix vP or to a functional projection between vP and the surface subject position; the example in (iia) is assigned the structural representation in (iib):

- (ii) a. John will buy the book if he finds it
 b. [CP [IP John [I^o will]] [vP [vP buy the book][CondCP if he finds it]]]

From the interpretive viewpoint, event conditionals form a complex predicate with the matrix vP, which places them within the c-command domain of operators in the matrix CP.

¹⁸. For example, von Stechow (1994) points out that *if*-clauses can either be topical (more commonly) or express new information, depending on the context, as highlighted by the contrast between (i) and (ii); the conditional clause can precede the main clause only when it conveys known information (like in (i)), functioning informationally as a topic:

Conditional adjuncts with inversion – which, as we have seen in the previous section, must precede the main clause – can optionally be resumed by the connector *(al)lora* both in standard Italian and in Paduan:

- (38) a. Fosse Mario arrivato in tempo, *(allora)* avremmo potuto partire
 b. Fùsselo Mario rivà in tempo, *(lora)* garissimo podùo partire
 Were-scl Mario arrived in time, (then) could have left
 ‘Had Mario arrived in time, (then) we could have left’

In the case of preposed alternative concessive conditionals, the insertion of an appropriate resumptive element in the main clause is almost obligatory, as exemplified with Italian and Friulian:

- (39) a. Sia Antonio arrivato o meno, io me ne vado *comunque/in ogni caso/lo stesso*
 Be Anthony arrived or less, I cl-cl-go *anyhow/in any case/the same*
 b. Sédial rivàt o no sédial rivàt, jo o vai vie *istés*
 Be-scl arrived or not be-scl arrived, I scl-go away the same
 ‘Whether [Anthony] has arrived or not, I’m going away *anyhow*’

-
- (i) a. What will you do if I give you the money?
 b1 If you give me the money, I’ll buy this house
 b2 #I’ll buy this house if you give me the money
- (ii) a. Under what conditions will you buy this house?
 b1 #If you give me the money, I’ll buy this house
 b2 I’ll buy this house if you give me the money

He assimilates conditional clauses as correlatives, proposing that in *if-then* conditionals the preceding *if*-clause is left dislocated and *then* functions as a resumptive element: the correlative structure *if-then* confers a topical status to the dislocated *if*-clause, which means that alternatives to the antecedent must be conceivable. An example like (iia) is assigned the structural representation in (iib):

- (iii)a. *Wenn es regnet, dann* werden wir zu Hause bleiben
 ‘If it rains, then we will stay at home’
 b. [CP Wenn es regnet [CP dann [C° werden] [IP wir zu Hause bleiben]]]

However, the possibility of being resumed by a resumptive form is shared by all preposed conditional clauses, irrespectively of whether they contain inversion subject or are introduced by a complementizer.

More distinctive features of conditionals with inversion, revealing their intrinsically topical nature, are the following. First, unlike conditionals introduced by *se* or *che*, they cannot be used in isolation, for example as an answer to a question, as witnessed by Paduan (40) and Friulian (41):

- (40) a. In che caso garissito podùo partire?
 ‘In which case could you have left?’
 b1. Se (Mario) el fusse rivà in tempo.
 ‘If (Mario) had arrived in time’
 b2. *Fùsselo (Mario) rivà in tempo.
 ‘Had (Mario) arrived in time’

- (41) a. In ce câs vâtu vie?
 ‘In which case are you going away?’
 b1. C'al sédi rivàt o c'a no'l sédi rivàt.
 ‘Whether he has arrived or not’
 b2. ??Sédial rivàt o no sédial rivàt.
 ‘Has-he arrived or not’

Moreover, unlike ordinary conditionals, inverted conditionals cannot be focussed or modified by focussing elements:

- (42) a. SE EL VEGNISSE, podaria dirghelo, no se el telefonasse.
 b. *VEGNISSELO, podaria dirghelo, no telefonasselo.
 ‘[If he came] I could tell him, not if he phoned’

- (43) a. *Solo/proprio/parfin* se el vegnisse, podaria dirghelo.
 b. **Solo/proprio/parfin* vegnisselo, podaria dirghelo.
 ‘[Only/just if he came], could I tell him’

Iatridou & Embick (1994) point out that in English inverted conditionals are subject to similar restrictions; they suggest that the function of inversion is to establish a

connection to previous discourse and, consequently, to indicate that the truth-value of the proposition in the antecedent is old or known information.¹⁹

Some recent analyses - e.g. Bayer (2001) among others – propose that a node responsible for informational packaging is available exclusively in main clauses, and not in (some types of) embedded clauses. In particular, Haegeman (2002) argues that adverbial clauses – among which event conditionals – not being selected by the main predicate, are part of the speech act of the main clause; more precisely, in this kind of clauses the node encoding illocutionary force is missing, and therefore there is straight connection path linking them to the speaker, and their force remains unanchored.

If the syntactic process of topicalization is dependent on force in the sense that it expresses what is topic from the speaker's perspective, the preposing of conditionals might be traced back to the necessity of getting in a local relation with the matrix node encoding a speech act feature.²⁰

3.3.2. Topicalization inside conditional topics: on the structural deficiency of conditionals

As anticipated above, Haegeman (2002) distinguishes *event conditionals* from *premise conditionals*.

Based on the observation that in English only adjuncts can undergo topicalization internally to a conditional, as witnessed by the contrast between (44a) and (44b), Haegeman modifies Rizzi's (2001b) proposal reported in (45a), and proposes that event conditionals lack both a Topic and a Focus projection, as represented in (45b):

¹⁹. Their descriptive generalization is based on the following evidence: first, both in English and Dutch, unlike *if*-conditionals, inverted conditional antecedents may not be modified by adverbs like *even/only*; secondly, unlike regular *if*-clauses, verb initial adjuncts may not be clefted; thirdly, unlike conditional antecedents introduced by *if*, inverted conditionals may not be used as answers to questions. The authors propose that these contrasts result from a more general property of inverted conditional adjuncts, namely, that they can not be focussed, and suggest assessing a correlation between inverted antecedents and old information. They also observe that - crosslinguistically - antecedents with counterfactual inversion are less restricted in their distribution than their indicative counterparts, as they may follow the main clause more frequently.

²⁰. For recent proposals on the syntactic encoding of speech act and clausal type the reader is also referred to Portner & Zanuttini (2002) and Speas & Tenny (2002).

- (44) a. *If the final exams you don't pass, you won't obtain the degree
 b. If with these precautions you don't succeed, you should try again next week

- (45) a. Force *Topic Focus* Mod Fin
 b. Event-conditionals: Force/Sub Mod Fin

Adopting the structure in (45a), she suggests that topicalized adjuncts target the specifier of the lower projection *ModP*.

Internal topicalization is generally possible in standard Italian in conditional clauses introduced by the subordinating complementizer *se*. However, the possibility to topicalize a constituent internally to a conditional adjunct is subject to restrictions: topicalization inside an ordinary conditional is felicitous only when the *if*-clause precedes the main clause, that is, when it has itself been topicalized to the left periphery of the main clause, as witnessed by the contrast between (46b1) and (47b2).²¹

- (46) a. Cosa sarebbe successo se io non avessi superato gli esami finali?
 'What would have happened if I hadn't passed the final exams?'
 b1. Se gli esami finali tu non li avessi superati, non avresti ottenuto il diploma

²¹. A similar constraint is discussed by Bayer (2001) with respect to the phenomenon labelled *emphatic topicalization* in Bavarian; contrasts such as the one between (ia) and (ib) show that the topicalization of the subject is licit only when the *if*-clause precedes the main clause:

- (i) a. Da Xaver wenn hoam kummt kriagt-a was z'essn
 'As for Xaver, if he comes home, he will get something to eat'
 b. *Da Xaver kriagt was z'essn der wenn hoam kummt
 'As for Xaver, he will get something to eat, if he comes home'

More generally, it is possible to topicalize the subject of the embedded clause only when it precedes the main clause; following the spirit of Bayer's (2001) account, I will assume that internal topicalization is made possible by fronting of the adjunct clause to [*Spec, CounterfP*] of the matrix clause. Note however that in (ia) the position occupied by the topicalized constituent is external to the conditional clause, as it precedes the subordinating complementizer. On the interpretive properties of the preposed constituent in the Bavarian construction see also Guidolin (this volume).

For an analysis of a similar constraint in Bangla the reader is referred to Bhattacharya (2001).

- b2. Se tu non avessi superato gli esami finali, non avresti ottenuto il diploma
 ‘If [the final exams] you hadn’t passed [the final exams], you wouldn’t have got the certificate’
- (47) a. In quale caso non avrei ottenuto il diploma?
 ‘In which case wouldn’t I have obtained the certificate?’
- b1. Non avresti ottenuto il diploma se non avessi superato gli esami finali
- b2. #Non avresti ottenuto il diploma se gli esami finali tu non li avessi superati
 ‘You wouldn’t have obtained the certificate if [the final exams] you hadn’t passed [the final exams]’

Interestingly, internal topicalization is impossible in conditionals displaying subject inversion:

- (48) a. Cosa sarebbe successo se tua sorella non avesse superato gli esami finali?
 ‘What would have happened if your sister hadn’t passed the final exams?’
- b1. Non avesse (mia sorella) superato gli esami finali, (allora) avrebbe potuto ritentarli.
- b2. ??Non li avesse, gli esami finali, (*mia sorella) superati, (allora) avrebbe potuto ritentarli.
- b3. *Gli esami finali non li avesse (mia sorella) superati, (allora) avrebbe potuto ritentarli.
 ‘If my sister hadn’t passed the final exams, (then) he could have tried again’

As will be discussed more in detail below in section, the impossibility to topicalize a constituent inside a protasis with inversion witnesses verb movement to the relevant head of the CP area inside the adjunct clause.

If, on the other hand, standard Italian allows for topicalization in conditionals introduced by *se*, we must conclude that a landing site must be available for internally topicalized constituents; following Benincà (2001), I will assume that, at least in standard Italian, no topic position is available below *FocusP*, and that, consequently, in event conditionals topicalized phrases do indeed target the specifier of a *TopicP*.

The hypothesis that adverbial clauses lack a *FocusP* is supported by the fact that in Italian both concessive and conditional clauses resist internal focalization of a constituent, independently of the respective order of the two clauses and of the presence of subject inversion:

- (49) a. *Tua sorella non sarebbe partita, (anche) se IL MIO MESSAGGIO avesse ricevuto
 b. *(Anche) se IL MIO MESSAGGIO avesse ricevuto, tua sorella non sarebbe partita
 ‘[Your sister would not have left] (even) if MY MESSAGE she had received [your sister would not have left]’
- (50) a. (Anche) avesse Antonio ricevuto il mio messaggio, tua sorella non sarebbe partita
 b. *(Anche) IL MIO MESSAGGIO avesse Antonio ricevuto, tua sorella non sarebbe partita
 c. *(Anche) avesse IL MIO MESSAGGIO Antonio ricevuto, tua sorella non sarebbe partita
 ‘(Even) if Anthony had received my message, your sister would not have left’

This restriction can be easily captured by the assumption that the CP layer of adjunct clauses is deficient in that it lacks a Focus projection. In light of the alleged absence of both a *FocusP* and a node encoding information about the speech act, adverbial clauses can be viewed as structurally deficient as they have a reduced left periphery, as proposed by Haegeman (2002).²²

4. On the landing site of preposed adjunct clauses

An analysis of the ordering restriction discussed in the previous section in terms of movement leads to a precise determination of the position targetted by preposed adjunct clauses. In this section I will try to identify the relevant landing sites with respect to the functional projections which have recently been argued to make up the richly articulated structure of the left periphery of the sentence.

²². Adopting this perspective, one could try to account for the obligatory displacement of the protasis under Cardinaletti & Starke’s (1999) theory of structural deficiency, according to which structurally poorer constituents tend to appear displaced from their base position to a higher site. So, the ordering restriction on inverted conditionals would be derivable from an independently motivated formal condition predicting that structurally poorer constituents appear higher in sentence structure, which drives the widespread movement operation displacing unfocused material to the left.

4.1. Embedding clausal adjuncts in a split left periphery

The functional skeleton of the split left periphery has been outlined by Rizzi (1997) as in (51), a proposal that has been revised and further expanded by Benincà (2001) as in (52):

(51) [ForceP [TopP [FocP [TopP [FinP]]]]]

(52) [*DiscP* Hanging Topic [*ForceP* Excl-*wh* [*TopP* Left Disl [*FocP* Interr-*wh*/Focus [*FinP*]]]]]

I will try to determine the relative order of preposed conditional/concessive clauses with respect to the different kinds of constituents that can appear in the left periphery on the basis of the sequence in (52).

As shown by the following data from Paduan, in interrogative clauses containing a topicalized constituent a preposed conditional or concessive clause must precede both the left-dislocated constituent, and the *wh*-item along with the inflected verb:

- (53) a. Fùsselo vegnùo anca Mario, a to sorèla, cossa garissito podùo dirghe?
 b. ??A to sorèla, fùsselo vegnùo anca Mario, cossa garissito podùo dirghe?
 c. *A to sorèla, cossa, fùsselo vegnùo anca Mario, garissito podùo dirghe?
 d. *A to sorèla, cossa garissito, fùsselo vegnùo anca Mario, podùo dirghe?
 Were-scl come also Mario, to your sister, what have-cond-scl been able tell her?
 ‘If Mario had come as well, what could you have told your sister?’

- (54) a. Anca ben vegnissela, a chi podarissito presentarghela?
 b. ??A chi, anca ben vegnissela, podarissito presentarghela?
 c. *A chi podarissito, anca ben vegnissela, presentarghela?
 Even well came-scl, to whom could-scl introduce-her?
 ‘Even if she came, to whom could you introduce her?’

This suggests that the landing site of the adjunct clause is higher than FocusP, standardly viewed as the target of *wh*-items, and higher than TopP, the landing site of left-dislocated constituents.²³

Furthermore, a preposed adjunct clause precedes the *wh*-item even in exclamative clauses, as witnessed again by Paduan, again showing that the landing site is higher than ForceP, identified by Benincà (2001) as the landing site of complex *wh*-phrases in exclamatives:

- (55) a. Vegnisselo putacaso anca Mario, quante robe no podarissito contarghe!
 b. *Quante robe, vegnisselo putacaso anca Mario, no podarissito contarghe!
 c. *Quante robe no podarissito, vegnisselo putacaso anca Mario, contarghe!
 [How many things], came-scl suppose also Mario, [how many things] not could-scl tell him!
 ‘Suppose Mario came as well, [how many things] you could tell him!’
- (56) a. Anca ben fùsseli rivai in tempo, quante robe che i se gavarìa desmentegà!
 b. *Quante robe, anca ben fùsseli rivai in tempo, che i se gavarìa desmentegà!
 c. ??Quante robe che, anca ben fùsseli rivai in tempo, i se gavarìa desmentegà!
 [How many things], also well were-scl arrived in time, [how many things] that they scl-have-cond forgotten!
 ‘Even if they had arrived in time, how many things they would have forgotten!’

Interestingly, the preposed clause must follow a constituent functioning as hanging topic, which has an obligatory pronominal resumption inside the main clause:

²³. As witnessed by standard Italian, a preposed (alternative concessive) conditional clause precedes both a focalized constituent and a left dislocated constituent:

- (i) a. Fossero arrivati in ritardo (o meno), IL PANE avrebbero dovuto comprare
 b. *IL PANE, fossero arrivati in ritardo (o meno), avrebbero dovuto comprare
 ‘[THE BREAD], had they arrived late (or not), [THE BREAD] they should have bought’
- (ii) a. Fossero arrivati in ritardo (o meno), il pane, avrebbero dovuto comprarlo
 b. ??Il pane, fossero arrivati in ritardo (o meno), avrebbero dovuto comprarlo
 ‘[The bread], had they arrived late (or not), [the bread], they should have bought’

- (57) a. Mario, (anca) gavesseli telefonà in tempo, no garissimo dovùo dirghelo
 b. ??(Anca) gavesseli telefonà in tempo, Mario, no garissimo dovùo dirghelo
 ‘[Mario], (even) had-scl phoned in time, [Mario], not have-cond must tell-him’
 ‘Mario, (even if) had they phoned in time, we shouldn't have told’

We must conclude that the movement operation preposing a conditional or concessive clause targets a specifier position inside the left periphery of the main clause which is located between ForceP and DiscP, the position allegedly occupied by preposed phrasal constituents functioning as hanging topics establishing a link to a previous discourse.

4.2. Two different targets

As pointed out by Iatridou (2000), crosslinguistically, the morphological features of the verb in a counterfactual *if*-clause are the same as the ones found in the complement of a counterfactual wish, according to the template in (58) - where *M* indicates verbal morphology - exemplified with standard Italian in (59):

- (58) a. if...M1...then...M2...
 b. want-M2 that...M1...
- (59) a. *Se venisse, me ne andrei*
 ‘If he *came*, I would go’
 b. *Vorrei che venisse*
 ‘I wish he *came*’
 c. *Se venisse!*
 ‘If only he *came!*’

However, as witnessed by (59c), optative clauses generally surface as main clauses and so it could a priori be expected for them to be compatible with a conditional clausal adjunct.²⁴ As shown by the following examples from Paduan, full ungrammaticality

²⁴ Indeed, as observed above in section 3.1.1, conditional adjunct clauses can express a desiderative reading; however, when they function as apodoses they can marginally precede the *if*-clause, while the two clauses are more clearly incompatible in the reverse order, that is, when the *if*-clause precedes, as shown by the following contrast in standard Italian:

- (i) a. ?*Trovasse almeno il coraggio di parlarle, se venisse anche lei!*
 ‘If only he dared to speak to her, if she came too!’

arises when both clauses display subject clitic inversion, irrespective of their relative order:

- (60) a. *Vegnisse-lo putacaso anca Mario, gavessela modo de parlarghe!
 b. *Gavessela modo de parlarghe, vegnisse-lo putacaso anca Mario!
 [Came-scl suppose also Mario], had-scl way of speaking-him, [came-scl
 suppose also Mario]!
 ‘Suppose Mario came, I wish she could speak to him!’

This incompatibility already strongly suggests that the interpretive features responsible for the optative and hypothetical readings are encoded in one and the same functional projection of the left periphery; moreover, considering the morphosyntactic and semantic closeness of the two readings, it is highly plausible that they are both expressed by a functional head labelled here – for the sake of transparency – *Counterf(actual)P*.

So, while the optative reading of (11) is triggered by verb raising to (the head) *Counterf^o*, the hypothetical reading of (12) involves preposing of the conditional clause to the specifier of *CounterfP*; the two derivations are represented in (61):

- (61) a. [*CounterfP* [*Counterf^o* [ti vessjo]_x [*ForceP* [*TopP* [*FocP* [*FinP* ...t_x...dit la veretà...]]]]]]!
 b. [*CounterfP* [*CP* vinisial tjo pari]_x [*Counterf^o*] [*ForceP* [*TopP* [*FocP* [*FinP* ...o podaresin là...t_x]]]]]]!

Starting from the assumption that in main optatives the inflected verb raises itself to the head *Counterf^o* for clausal typing purposes, the incompatibility witnessed by (60) can be traced back to a constraint on checking preventing the activation of both the specifier and the head of the same projection, as long as they encode slightly different interpretations.²⁵

-
- b. ??Se venisse anche lei, trovasse almeno il coraggio di parlarle!
 ‘If she came too, I wish he dared to speak to her!’

²⁵. Under a strictly cartographic approach, the pattern attested in Carmignano di Brenta and reported in (15) would force us to a further splitting, distinguishing a *Counterf(actual)^o* proper, encoding the hypothetical/counterfactual interpretation, from a structurally lower *Opt(ative)^o*, responsible for the

Unlike ordinary conditionals, alternative concessive conditionals are compatible with optative clauses; either clause can contain subject clitic inversion, as witnessed by Paduan and Friulian in (62) and (63) respectively:

- (62) a. Che'l vegna o che no'l vegna, telefonasse-lo almanco!
 that scl-come or that not-scl-come, phoned-scl at least
 b. ??Telefonasse-lo almanco, che'l vegna o che no'l vegna!
 phoned-scl at least, that scl-come or that not-scl-come
 'Whether he comes or not, I wish he called at least!
- (63) a. Fossj-al vignùt o no fossj-al vignùt, s'al véss almancul clamàt!
 were-scl come or not were-scl come, if-scl-had at least phoned!
 b. ??S'al véss almancul clamàt, fossj-al vignùt o no fossj-al vignùt!
 if-scl-had at least phoned, were-scl come or not were-scl come
 'Had he come or not, if only he had phoned!'

Moreover, alternative concessive conditionals are compatible with *if*-clauses and tend to precede them, as shown again by Paduan and Friulian:²⁶

- (64) a. Che piova o che no piova, rivàsse-lo subito, podarissimo partire
 That rain or that not-rain, arrived-scl soon, could leave
 b. ??Rivàsse-lo subito, che piova o che no piova, podarissimo partire
 Arrived-scl soon, that rain or that not-rain, could leave
 'Whether it rains or not, if he arrived soon, we could leave'

desiderative reading. This hypothesis will be viewed as essentially correct, awaiting further empirical evidence to substantiate it.

²⁶. The same pattern is attested in standard Italian, as exemplified in (i) and (ii):

- (i) a. (Che) venga o (che) non venga, se telefonasse, potremmo dirglielo
 b. ??Se telefonasse, (che) venga o (che) non venga, potremmo dirglielo
 'Whether he comes or not, if he called, we could tell him'
- (ii) a. ?(Che) venga o (che) non venga, telefonasse, potremmo dirglielo
 b. *Telefonasse, (che) venga o (che) non venga, potremmo dirglielo
 'Whether he comes or not, called he, we could tell him'

- (65) a. Fossj-al vignùt o no fossj-al vignùt, s'al véssi clamaat, avaréssin podùt d'ìgilu
Were-scl come or not were-scl come, if-scl-had called, could have told-him-it
b. ??S'al vessi clamaat, fossj-al vignùt o no fossj-al vignùt, avaréssin podùt d'ìgilu
If-scl-had called, were-scl come or not were-scl come, could have told-him-it
'Had he come or not, if he had called, we could have told him'

These data clearly point to the postulation of a different (and higher) position as landing site for the alternative concessive conditionals, which I take to be the specifier of a functional projection labelled *Conc(essive)P*.

Adapting the analysis of coordinated structures suggested by Kayne (1994) – revising a proposal by Munn (1993) – the two members of the disjunctive cluster can be taken to occupy the specifier and the complement position of a *Disj(unction)P* headed by the disjunction *o*, as represented in (66b); subject clitic inversion inside the two clausal members is a reflex of verb raising to the head *Conc*^o, as a consequence of which the disjunctive cluster raises as a whole to the specifier of *ConcP* located in the left periphery of the main clause; the structural representation of an example like (13) would then be like in (66c):

- (66) a. Sedi-*al* pùar o sedi-*al* sior, no m'impuarte
b. [_{DisjP} [_{CP} sedial pùar]][_{Disj^o} o][_{CP} sedial sior]]
c. [_{ConcP}[_{DisjP} sedial pùar o sedial sior]_x [_{Conc^o}] [_{CounterFP} [_{ForceP} [_{TopP} [_{FocP} [_{FinP} ...no m'impuarte...t_x]]]]]]]]!

As for ordinary concessives with inversion, it seems that they are incompatible with an alternative concessive conditional, independently of their relative order:

- (67) ??Gavésselo telefonà o no gavésselo telefonà, anca ben fùsselo vignùo a
Had-scl phoned or not had-scl phoned, also well were-scl come to
trovarne, no garissimo podùo dirghe gnente
find-us, not have-cond been-able tell-him nothing

- (68) *Anca ben fùsselo vignùo a trovarne, gavésselo telefonà o no gavésselo
 also well were-scl come to find-us, had-scl phoned or not had-scl
 telefonà, no garissimo podùo dirghe gnente
 phoned, not have-cond been-able tell-him nothing
 ‘Had he phoned or not, even if he had come visit us, we couldn't have told him
 anything’

The ungrammaticality of (67) and (68) can be interpreted as showing that only one concessive clause can precede a main clause, in other words, that the projection *ConcessiveP* is not recursive.

I would like to suggest that the reading of an ordinary concessive adjunct clause employs both layers, along the following lines:

- (69) a. [ConcP *anca (ben)* [Conc°] [CounterfP [Counterf° *vignisselo*].....
 b. [ConcP [Conc° [*vignisselo*]x] [CounterfP *anca* [Counterf° tx].....

So the inflected verb can raise either to *Counterf°* or to *Conc°*, while *anca* can occupy the specifier of either projection, producing the two grammatical orders.²⁷

5. On the hierarchical ordering of the relevant projections

Based on the ordering restrictions discussed in the previous sections, by embedding preposed adverbial clauses in the layered left periphery in (52) we obtain the following outline of functional projections of the CP field, hierarchically organized in a fixed order, where the two projections *ConcessiveP* and *CounterfactualP* should be regarded as encoding specific instantiations of clausal type:²⁸

²⁷. In the ungrammatical sequence, one might imagine that the verb raises to a head higher than *Conc°*, crossing over *anca ben* located in the specifier of *ConcP*:

(i) *[XP [*vignisselo*]x [ConcP *anca ben* [Conc° tx] [CounterfP [Counterf° tx].....

²⁸. Given the sequence in (73), we can now get back to the issue addressed in section 3: if protases, as proposed, do indeed have a *TopicP*, internal verb raising to *Counterf°* implies raising through the lower head positions, including *Top°* (and excluding *Foc°*, if the adjunct clause indeed lacks a Focus projection); the activation of the head *Top°*, a side effect of verb raising, results not only in blocking the

(70) [DiscourseP [ConcessiveP [CounterfactualP [Force=ExclamativeP [TopicP [Focus/InterrP [FinP]]]]]]]]

By carefully dissecting the identified sequence and excorporating from it the positions relevant for clausal typing, we obtain the hierarchy in (71):²⁹

(71) *Concessive* > *Counterfactual* >>> *Exclamative* > *Interrogative*

As for the precise location of the sequence of projections in (71), following the well-motivated standard assumption that the projection encoding the interrogative interpretation is situated within the CP-field, we are forced to the conclusion that the other projections considered here, being hierarchically higher, belong to the same structural layer. In this sequence each head can be seen as the syntactic encoding of the

access to [*Spec,Top*] (thereby excluding internal topicalization, as we have seen) but also in marking the whole clausal constituent as a topic; on the other hand, if topicality is codified in relation with a force node, which is missing in the adjunct clause, this will trigger its compulsory preposing to target an appropriate specifier ([*Spec,CounterfP*] or [*Spec,ConcP*]) of the matrix CP field, thereby determining the order in (ib):

- (i) a. *Saremmo potuti partire puntualmente, fosse tua sorella arrivata in tempo
 b. Fosse tua sorella arrivata in tempo, saremmo potuti partire puntualmente
 ‘Had your sister arrived in time, we could have left punctually’

Only in the landing site inside the main left periphery does the adjunct clause enter a local relation with the matrix node responsible for informational organization.

²⁹. The correctness of the relative order between *CounterfactualP* and *InterrogativeP* in this sequence, that is, of the hypothesis that the former occupies a structurally higher position, is confirmed by Iatridou and Embick’s (1994) crosslinguistic generalization according to which languages exhibiting counterfactual/ conditional inversion display inversion in interrogatives as well; they also point out that the set of languages allowing indicative inversion - not addressed here - constitutes a proper subset of those allowing counterfactual inversion. Furthermore, they observe that in some syntactic environments the verb movement to C° associated with conditional inversion is differentiated from other cases of verb movement.

speaker's typical mental attitude with respect to the propositional content expressed by the clause containing the verb with enclisis of the pronominal subject.³⁰

More precisely, taking into account Benincà's (2001) refinement of Rizzi's (1998) layout, where the projection hosting exclamative wh-phrases is identified with ForceP (the highest of Rizzi's CP-layers), the projections *ConcessiveP* and *CounterfactualP* could be regarded as specific instances of the Force layer, codifying different realizations of sentential type.³¹

Taking into account the two extreme projections, the lowest *Interrogative* and the highest *Concessive*, such a sequence can be made sense of if interpreted as reflecting a from right to left increasing degree of assertivity force, which is inversely related to a (from right to left) decreasing degree of salience for the speaker of the truth value of the event expressed by the clause: starting from the rightmost position encoding the interrogative reading, one can assume that the degree of the speaker's involvement gradually decreases to the minimal extent expressed by the concessive reading, whereas

³⁰. That the occurrence of enclisis of an inflectional morpheme on the finite verb may express a peculiar relation of the speaker with the propositional content is further suggested by data from other North-Eastern Italian dialects: as pointed out by Benincà (1996b), in some varieties of this area in the first and second plural person of verbal tenses characterized by a [-real] modality (like imperfect indicative and subjunctive and present conditional) an enclitic morpheme surfaces on the right of the inflected verb, even in the assertive conjugation; I suggest that this peculiarity of verbal morphology may be due to the fact that these two persons, by their intrinsic semantics, entail a reduced commitment by the speaker in asserting the truthfulness of his statement. On the one hand, unlike a singular one, a plural subject implies by definition a plurality of referents, hence requiring a higher level of knowledge of the world, which may induce the speaker to warn the addressee of the potentially reduced degree of objectivity of his statement; on the other hand, unlike with 3rd person subjects (whose referents are assumed to be absent from the discourse in the unmarked case), in the 1st-2nd plural person the speaker's subjective representation of the event can in principle be questioned by the other co-referent subjects, which again may weaken the speaker's self-confidence. If this interpretation of the data is on the right track, these inflectional endings represent a class of morphemes with interpretive properties similar to the ones of the enclitic pronominal subjects analyzed above.

³¹. An analysis in terms of incremental reduction of verb movement such as the one proposed here entails of course the crucial assumption that the whole set of functional layers defining this hierarchical ordering is projected in syntax even when it is devoid of content.

the intermediate positions express different ways of relating a given state of things to the speaker's individual perspective.

Let us consider now more closely the interpretive properties of each specific layer.

5.1. The phrasal constituent area

As observed above, a feature distinguishing Exclamative and Interrogative clause types from the two higher ones is that they are expressed through monoclausal structures, as a consequence of the fact that the specifier of the relevant projections involved can be the target of a phrasal constituent moving from inside the clause. Typically, the moved constituent belongs – or is introduced by an element belonging – to the paradigm of *wh*-items. Still, despite this similarity, we can split this lower area into two subparts characterized by particular properties.

5.1.1. The *identificational* layer

The genuinely interrogative reading, intended as real request for new information, is associated with/expressed by *InterrogativeP*, the lowest projection of our hierarchy, and most likely coinciding with the FocusP projection of Rizzi (1997) (and therefore to be clearly distinguished from Rizzi (2001)'s *IntP*, which is located higher in the left periphery). The raising of the inflected verb to the relevant position triggers a yes/no question; the corresponding specifier can be filled by a *wh*-item, to trigger a constituent question. The structural representation proposed for such cases is the following:

(72) [ConcP [CounterP [EvalP [IntP (COSSA) [Int^o *magne_{lo}*][Agr-SP *pro* [Agr-S^ot_x...]]]]]]?]

In *yes/no* questions the speaker asks the addressee to assign a truth value to the propositional content, while in *wh*-questions he requires the identification of an adequate referent for the *wh*-phrase. Moreover, the specifier of FocusP can be filled by a contrastively focalized constituent in order to correct a previous incorrect information. In view of this, the interpretations expressed by this low head involve a process of identification, to be applied to the truth value, to the variable of the *wh*-item, or to the focalized constituent; these cases can be subsumed under the common label of an *identificational* process, so that this low area can be defined as *identificational area*.

True interrogatives therefore express very weak, if any, assertive force, and, conversely, a high degree of involvement of the speaker in the speech act.

5.1.2. The *evaluative* layer

Recently, some authors have argued for a different landing site of *wh*-items when they occur in interrogative clauses which are not interpreted as standard questions, that is as genuine requests for information, but rather as biased questions through which the speaker intends to express his own view on a given state of things³². If these works are on the right track, they provide a strong empirical argument for the assumption that at least one - and most likely more than one - specifier position is available above FocusP, the one in which the standard interrogative interpretation is determined.

Furthermore, a higher and distinct landing site has been identified for *wh*-phrases in exclamative clauses, so that the *ExclamativeP* in (70) is associated with the exclamative reading.

In these cases the truth value of the event is determined contextually, and the referent of the *wh*-constituent is already known, but the event (or the degree expressed by the *wh*-word) is assigned by the speaker a certain relevance according to his (or to standard) expectations,

I propose to subsume the whole set of projections involved in these cases under the unifying label

Eval(uative); it is intended to cover here for simplicity the two cases exemplified in (9) and (10), namely *wh*-interrogatives having the pragmatic force of exclamatives and sentences expressing the speaker's negative presupposition with respect to the propositional content. As in both cases some form of evaluation of the speaker is entailed, I assume that in both cases raising of the inflected verb to *Eval*^o is involved, with additional raising of the *wh*-item to the corresponding specifier in (73a):

- (73) a. [_{ConcP} [_{CounterfP} [_{EvalP} Ce [_{Eval}^o mi tocial_x] [_{IntP} [_{Int}^ot_x] [_{FinP} di vjodi]]]]]]?!
 b. [_{ConcP} [_{CounterfP} [_{EvalP} [_{Eval}^o No mi tocial_x] [_{IntP} [_{Int}^ot_x] [_{FinP} di pajà la multe]]]]]]!

³². The reader is referred to Benincà (1996a) about *wh*-exclamatives, Munaro & Obenauer (1999) about *pseudo*-interrogatives, Obenauer & Poletto (2000) about rhetorical questions, and to Obenauer (1994) for a detailed analysis of different kinds of *wh*-questions. Although adopting Kayne (1994)'s antisymmetric approach and its single-specifier syntactic structure we would be led to postulate a functional head corresponding to each of the specifier positions argued for in the above mentioned studies, for the purposes of the present work the general label *Eval(uative)* is intended to cover the whole functional area hosting the projections activated in these structures.

In the second case, the compatibility of the propositional content with the speaker's personal expectations depends crucially on the presence of preverbal negation.³³

As is intuitively clear, exclamatives and biased interrogatives convey a greater degree of assertive force than genuine interrogatives, as in these contexts the propositional content, the referent or the degree expressed by the *wh*-word, is assigned by the speaker a certain relevance according to his (or to standard) expectations; hence exclamatives and biased questions, even if they have a presupposition, do not themselves have assertive force, since their content cannot be valued in terms of truth *vs* falsity, as their function is to widen the range of alternatives under consideration, thereby enabling the speaker to express some form of evaluation on the event, which witnesses a degree of involvement of the speaker in the speech act.³⁴

5.2. The clausal-constituent area

Let us consider now more closely the two positions in the upper part of the sequence in (71). As pointed out in section 2, the range of variation attested crossdialectally concerns more robustly the syntactic contexts exemplified in (11)-(13); moreover, the chart in (20) reveals a consistent solidarity between the optative and the hypothetical reading as opposed to the alternative concessive one; this provides additional evidence for splitting the upper portion of (71) into at least two different positions, which we have labelled *Counterf(actual)*^o (subsuming both the optative and the hypothetical reading) and *Conc(essive)*^o.

The concessive and counterfactual readings of inversion (as opposed to the others) are associated to biclausal structures; the ordering restrictions attested in these cases suggest

³³. The preverbal negative marker can trigger a presuppositional implication both in *yes/no* exclamatives and in *wh*-exclamatives, as thoroughly discussed in Portner & Zanuttini (1996). According to Zanuttini & Portner (2000), Portner & Zanuttini (2002), exclamative clauses have two basic semantic properties: (a) *factivity*, as the propositional content of the exclamative is presupposed to be true; (b) *widening*, as exclamatives are always uttered against a background of a set of alternative propositions.

³⁴. As observed by Sadock & Zwicky (1985:164), “exclamations are intended to be expressive, whereas declaratives are intended to be informative [...] in an exclamation the speaker emphasizes his strong emotional reaction to what he takes to be a fact [...] exclamations are, like interrogatives, non-assertive...”.

that *ConcP* and *CounterfP* can be activated by raising of the embedded clause to the relevant specifier of the main clause (and presumably by verb raising inside the adjunct clause).

Looking at (70), it is easy to determine that they define a sublayer located between the lower area, the target of phrasal constituents of the main clause, and *DiscourseP*, which functions as an interface with the discourse domain; indeed, these two projections, hosting preposed adjunct clauses, can be characterized as expressing the relation between the main clause and clausal modifiers: adopting this perspective, the sequence in (70) reflects the intuition that interclausal relations are computed at a level of linguistic representation which is sandwiched between clause-internal relations and connections to the discourse.

5.2.1. CounterfactualP

The projection *CounterfP* encodes the optative and hypothetical reading exemplified in (11)-(12); if accessible, this projection conveys a counterfactual entailment, in that both optatives and protases with subject inversion have a strong counterfactual flavour, as opposed to the corresponding structure with the complementizer.³⁵

³⁵. This observation is supported by the fact that in Paduan inverted conditional clauses with a verb in a non-compound tense full grammaticality is achieved by adding an adverb like *suppose*, as opposed to the corresponding structure with the complementizer:

- (i) a. Se vignisse anca Mario, podarissimo partire
- b. ?Vignisse-*lo* anca Mario, podarissimo partire
- c. Vignisse-*lo* putacaso anca Mario, podarissimo partire
- Came-scl [suppose] also Mario, could leave
- ‘If Mario came as well, we could leave’

More generally, in the North-Eastern Italian dialects considered here the inflected verb of inverted conditionals appears in the (imperfect or pluperfect) subjunctive. Portner (1992) states that conditionals with subjunctive antecedents implicate that their antecedents are false (and that pluperfect subjunctive tends strongly to be viewed as contrary to fact); similarly, Giorgi & Pianesi (1997) propose that subjunctive conditionals are always counterfactual and that counterfactuality requires some attitude of the speakers toward the truth of the protasis.

Moreover - as pointed out to me by Guglielmo Cinque - subject inversion in standard Italian leads to uncancelability of counterfactuality:

- (ii) a. Se Gianni avesse bevuto del vino, avrebbe le guance rosse...ed infatti ce le ha

These readings are triggered by verb raising to *Counterf*^o and by raising of the embedded clause to the specifier of *CounterfP* of the main clause respectively:

- (74) a. [ConcP [CounterfP [Counterf^o *tivàsselo*_x][EvalP [Eval^o *t*_x][IntP [Int^o *t*_x][Agr-SP *pro* [Agr-S^o *t*_x]]...in tempo almanco]]]]]]!
 b. [ConcP [CounterfP [fùsselo vegnù anca Mario]_x][Counterf^o][EvalP [IntP [Agr-SP *pro* [Agr-S^o *gavaressimo*]]...podù dirghelo...*t*_x]]]]]]!

In optatives with inversion the speaker expresses his own hope for the realization of a situation in which the propositional content were/had been assigned a counterfactual truth value; in this sense, optatives do have an assertive force of their own as they implicitly express, by contrast, that their propositional content is (or was) contrary to fact.

In inverted conditionals, on the other hand, the speaker takes into account the potential consequences of a situation in which the event expressed by the embedded clause had been assigned a counterfactual truth value or makes the realization of the event expressed by the apodosis dependent on a situation in which the clausal content of the protasis were/had been assigned a counterfactual truth value; in this case, the assertive force is explicitly expressed through the matrix clause, which is in the unmarked case a statement.³⁶

-
- b. *Avesse Gianni bevuto del vino, avrebbe le guance rosse...ed infatti ce le ha
 ‘If Gianni had drunk some wine, his cheeks would be red...indeed they are’

³⁶. I have suggested above that subject-verb inversion entails internal raising of the inflected verb to the head *Counterf*^o for clausal typing purposes; given the sequence in (70), the sharp deviance of (48b2) can be accounted for under the assumption that verb raising through *Top*^o makes [*Spec, TopP*] inaccessible; independent support for this analysis comes from the fact that in English, conversely, a constituent in [*Spec, Top*] blocks verb movement to *Top*^o, as pointed out in Haegeman & Guéron (1999):

- (i) a. I promise that *on no account will* I write a paper during the holidays
 b. *I promise that *during the holidays will* I on no account write a paper

As for the ungrammaticality of (48b3), in which the topicalized phrase precedes the inflected verb, it can be attributed to the absence of a *TopP* above *CounterfP*. On the other hand, if the complementizer *se* is realized, the verb needn't raise, and [*Spec, TopP*] remains accessible to phrasal constituents, as shown by (46b1).

5.2.2. Concessive P

Finally, *ConcessiveP* is associated with the concessive or concessive conditional reading, where the speaker takes into account either an eventuality or - in the case of a disjunctive cluster - both truth values for the same propositional content (or, alternatively, two different events) evaluating them as irrelevant for the realization of the event of the main clause.³⁷ The concessive reading exemplified in (13) is triggered by verb raising to *Conc*^o inside the adjunct clause, followed by raising of the concessive cluster to the specifier of *ConcP* of the main clause:

(75) [_{ConcP} [_{magne/lo o no magne/lo}]_x [_{Conc^o}][_{CounterfP}[_{EvalP} [_{IntP} [_{Agr-SP} *mi* [_{Agr-S^o} *preparo*]]..._{lo} _{stesso...t_x}]]]]]!

The concessive conditional interpretation requires that a condition or a pair of antecedent conditions be evaluated in the structure, so that the consequent holds independently of their value; it is precisely in this sense that a concessive conditional, or, more precisely, the main clause associated with a concessive conditional, expresses

³⁷. According to the analysis developed by Quer (1998), concessive conditionals relate a set of antecedents to a consequent either by a disjunction of a conditional and its negation - *alternative concessive conditionals* - or by a focus particle or scalar expression that modifies a conditional - *polar concessive conditionals*; the two types of concessive conditionals are exemplified by the Catalan examples in (i) and (ii) respectively:

- (i) a. *Li agradi o no (li agradi), se'l prendrà*
 'Whether he likes-subj it or not, he will drink it'
 b. *Et posis aquí o (et posis) allà, em molestes*
 'Whether you come-subj stand here or you go-subj stand there, you disturb me'
- (ii) a. *Fins i tot si m'ho paguessin, no hi aniria*
 'Even if they paid-subj it for me, I would not go'
 b. *Encara que no em convidi a la festa, li faré un regal*
 'Even if he does not invite-subj me to the party, I will buy him a present'

Quer points out that concessive conditionals are licensed in modal environments and involve a non-veridical model of evaluation that contains a set of worlds.

the strongest degree of assertive force and the weakest degree of involvement of the speaker in the propositional content.^{38,39}

³⁸. The marginality of (21f) confirms the correctness and the crosslinguistic validity of a hierarchical order in which the concessive reading is associated with the leftmost, hence highest, structural position. As for the presence of disjunction in concessive conditionals, Higginbotham (1991) views every *or* as an *either/or*, i.e. as part of a larger constituent including *either* or its interrogative counterpart *whether*, so that (ia) is semantically equivalent to (ib):

- (i) a. If you (either) marry her or don't marry her, you will regret it
 b. If you marry her, you will regret it, and if you don't marry her, you will regret that too

³⁹. Under an account of the attested crossdialectal variation in terms of incremental reduction of verb movement, an obvious problem is posed by the pattern reported in footnote 12: assuming a hierarchical order such as the one sketched above, one would not expect the ungrammaticality of (id-e) involving the projection *CounterfP*, given the grammaticality of (if) involving *ConcP*. However, disjunctive structures involving two alternative values rather than the positive-negative opposition are not equally accepted:

- (i) ??Magneło ale doi o magneło ale quattro, mi parecie instéss
 'Eats-scl at two or eats-scl at four, I prepare anyhow'

This might mean that the type of disjunction relevant for *ConcP* is the one with two alternative values, as exemplified in (13) with Friulian. If this hypothesis is correct, then the distributional pattern of inversion in this variety of Northern Veneto does not represent a counterexample to the hierarchical sequence identified.

Notice further that in the North-Eastern Lombard varieties displaying *do-support* in interrogatives inversion is compatible with the disjunctive reading, as exemplified in (ii) with the dialect of Monno:

- (ii) a. vègn-el o vègn-el mia, no m'ha da 'ndà
 comes-scl or comes-scl not, we scl-have to go
 'whether he comes or not, we have to go'
 b. plö-el o plö-el mia, m-vol fa ina girada
 rains-scl or rains-scl not, scl-want do a trip
 'whether it rains or not, we go for a trip'

Given the hierarchical order identified, it is unexpected that in these varieties the disjunction can be expressed by means of subject clitic inversion rather than through the *do-support* strategy available in interrogatives; however, under the present analysis (according to which the checking of the disjunctive

6. Conclusion

Carrying out a crosslinguistic comparison among some North-Eastern Italian varieties it has been shown that clauses containing a verbal form with enclisis of the pronominal subject can be associated to different subsets of a given range of possible readings.

The various interpretations expressed by this class of enclitic morphemes can be characterized as implying a less objective representation of the propositional content than the one conveyed in assertive contexts; whenever subject clitic inversion obtains, the event is presented subjectively, that is, related to the speaker's observational perspective.

The range of variation detectable from the comparison among the different dialects examined has been traced back to precise structural conditions: it has been argued that each type of interpretation is triggered by the raising of the inflected verb to a different landing site inside the CP-layer; hence, the attested crossdialectal variation provides suggestive evidence for the existence of a few functional projections encoding some aspects of the speaker's relation to the propositional content expressed by the clause. Relying on previous work on the structural articulation of the left periphery, I have proposed that the projections devoted to clausal typing are hierarchically organized in the following sequence of layers which reflects a from right to left increasing degree of assertive force:

(76) *Concessive* > *Counterfactual* >>> *Evaluative* > *Identificational*

I have also argued that clausal typing can be achieved inside a conditional or concessive clause by verb raising to an appropriate head of the CP field, without a subordinating complementizer; this in turn triggers raising of the clausal adjunct to the relevant specifier of the matrix CP field in order to enter a local relation with a force node.

The movement operation affecting conditional and concessive adjuncts targets the specifier of two functional projections located in the upper portion of the CP area, *ConcessiveP* for (alternative) concessive conditionals and *CounterfactualP* for counterfactual and optative conditionals; by encoding specific instances of clausal typing, these projections also codify interclausal relations.

feature is performed by the embedded clause), this follows from the fact that the *do-support* strategy is in general limited to main clauses.

Following some recent proposals on the internal shape of clausal adjuncts, I have also suggested that conditional clauses have a structurally deficient CP layer in that they lack both a node encoding informational structure and a node responsible for internal focalization of phrasal constituents.

References

- ASIS - Atlante Sintattico dell'Italia Settentrionale*, Centro di Studio per la Dialettologia Italiana "O. Parlangèli". CNR/Dipartimento di Linguistica - Università di Padova
- Bayer, J. (to appear) "Asymmetry in emphatic topicalisation". In C.Féry & W.Sternefeld (eds.), *Audiatur Vox Sapientiae*. Akademic Verlag, Berlin.
- Benincà, P. 1989. "Friaulisch: Interne Sprachgeschichte I. Grammatik". In *Lexikon der Romanistischen Linguistik*. vol. III. Tübingen - Max Niemeyer Verlag, pp.563-585.
- Benincà, P. 1996a. "La struttura della frase esclamativa alla luce del dialetto padovano". In P.Benincà, G.Cinque, T.De Mauro & N.Vincent (eds.), *Italiano e dialetti nel tempo. Saggi di grammatica per Giulio Lepschy*. Roma - Bulzoni, pp.23-43.
- Benincà, P. 1996b. "Agglutination and Inflection in Northern Italian Dialects". In *Aspects of Romance Linguistics: Selected papers from the XXIV Linguistic Symposium on Romance Languages*, pp.59-72.
- Benincà, P. 2001. "The Position of Topic and Focus in the Left Periphery". In G.Cinque & G.Salvi (eds.), *Current Studies in Italian Syntax - Essays offered to Lorenzo Renzi*. Amsterdam - Elsevier, pp.39-64.
- Bhattacharya, T. 2001. "The puzzle of Bangla Comp-internal clauses". *Snippets* 3, pp.6-7.
- Cardinaletti, A. & M.Starke. 1999. "The typology of structural deficiency: on the three grammatical classes". In H. van Riemsdijk (ed.), *Clitics in the Languages of*

- Europe*, vol. 8 of *Empirical Approaches to Language Typology*. Mouton de Gruyter, Berlin.
- von Stechow, K. 1994. *Restrictions on Quantifier Domains*. PhD dissertation, University of Massachusetts – Amherst.
- Giorgi, A. & F. Pianesi. 1997. *Tense and Aspect: from Semantics to Morphosyntax*. Oxford University Press, Oxford.
- Haegeman, L. 2002. “Anchoring to speaker, adverbial clauses and the structure of CP”. In S. Mauck & J. Mittelstaedt (eds.), *Georgetown University Working Papers in Theoretical Linguistics*, vol.2 - Fall 2002, pp.117-180.
- Haegeman, L. & J. Guéron. 1999. *English Grammar: A Generative Perspective*. Blackwell Textbooks in Linguistics 14, Blackwell Publishers.
- Higginbotham, J. 1991. “Either/Or”. *Proceedings of NELS 21*. Université du Québec à Montréal, pp.143-155.
- Hulk, A. 1993. “Residual Verb-Second and the Licensing of Functional Features”. *Probus* 5:127-154.
- Iatridou, S. 2000. “The Grammatical Ingredients of Counterfactuality”. *Linguistic Inquiry* 31.2:231-270
- Iatridou, S. & D. Embick. 1994. “Conditional inversion”. In M. González (ed.) *Proceedings of NELS 24*. University of Massachusetts, Amherst, pp.189-203.
- Kayne, R. 1994. *The Antisymmetry of Syntax*. LI Monographs 25, MIT Press.
- Munaro, N. 1997. *Proprietà strutturali e distribuzionali dei sintagmi interrogativi in alcuni dialetti italiani settentrionali*. PhD Thesis, Universities of Padua/Venice.
- Munaro, N. 2001. “I correlati interpretativi dell’inversione tra verbo e clitico soggetto: la dialettologia come *scienza di confine* tra teoria e dati”. In G. Marcato (ed.), *I confini del dialetto*. Padua - Unipress, pp.167-175.
- Munaro, N. 2002. “Splitting up subject clitic-verb inversion”. In C. Beyssade, R. Bok-Bennema, F. Drijkoningen, P. Monachesi (eds.), *Romance Languages and Linguistic Theory 2000*. John Benjamins, Amsterdam/Philadelphia, pp.233-252.
- Munaro, N. 2005. “Computational puzzles of conditional clause preposing”. In A.M. Di Sciullo (ed.), *UG and External Systems – Language, Brain and Computation*. John Benjamins – Amsterdam/Philadelphia, pp.73-94 .
- Munaro, N. & H.-G. Obenauer. 1999. “On Underspecified *Wh*-elements in Pseudo-interrogatives”. *University of Venice Working Papers in Linguistics* 9:181-253.
- Munaro, N., C. Poletto & J.Y. Pollock. 2001. “*Eppur si muove!* On Comparing French and Bellunese *Wh*-Movement”. In P. Pica and J. Rooryck (eds.), *Linguistic Variation Yearbook 1*. John Benjamins, Amsterdam/Philadelphia, pp.147-180.

- Munaro, N. & J.Y. Pollock. 2005. “*Qu’est-ce que (qu’)est-ce que?* A case study in comparative Romance interrogative syntax”. In G. Cinque & R. Kayne (eds.), *Handbook of Comparative Syntax*. Oxford University Press, pp.542-606.
- Munn, A. 1993. *Topics in the Syntax and Semantics of Coordinate Structures*. PhD dissertation, University of Maryland
- Obenauer, H.-G. 1994. *Aspects de la syntaxe A-barre. Effets d’intervention et mouvements des quantifieurs*. Thèse de Doctorat d’Etat, Université de Paris VIII.
- Obenauer H.-G. & C. Poletto. 2000. “Rhetorical *Wh*-phrases in the Left Periphery of the Sentence”. *University of Venice Working Papers in Linguistics* 10.1:121-151.
- Poletto, C. 2000. *The Higher Functional Field*. New York - Oxford University Press.
- Poletto, C. & J.Y. Pollock. 2004. “On the Left Periphery of Some Romance *Wh*-Questions”. Manuscript, CNR-Padua / Université de Picardie à Amiens.
- Pollock, J.Y. 2000. “Subject Clitics, Subject Clitic Inversion and Complex Inversion: Generalizing Remnant Movement to the Comp Area”. Manuscript, Université de Picardie à Amiens.
- Portner, P. 1992. *Situation Theory and the Semantics of Propositional Expressions*. PhD dissertation, University of Massachusetts – Amherst.
- Portner, P. & R.Zanuttini. 1996. “The Syntax and Semantics of Scalar Negation: Evidence from Paduan”. In *Proceedings of NELS 26*, pp. 257-271, University of Massachusetts – Amherst.
- Portner, P. & R.Zanuttini. 2002. “Clause Types: Form and Force in Grammatical Theory”. Talk delivered at the *Workshop on Syntax and Semantics of CP*, March 2002, Berlin ZAS.
- Quer, J. 1998. *Mood at the Interface*. Holland Academic Graphics, The Hague.
- Renzi, L. & L. Vanelli. 1983. “I pronomi soggetto in alcune varietà romanze”. In *Scritti linguistici in onore di Giovan Battista Pellegrini*, Pisa - Pacini, pp.121-145.
- Rizzi, L. 1982. *Issues in Italian Syntax*. Foris, Dordrecht.
- Rizzi, L. (1997) “The Fine Structure of the Left Periphery”, in L.Haegeman (ed.) *Elements of Grammar*, Kluwer, Dordrecht, pp.281-337
- Rizzi, L. (2001a) “On the position *Int(errogative)* in the left periphery of the clause”, in G.Cinque & G.Salvi (eds.) *Current Studies in Italian Syntax offered to Lorenzo Renzi*, North-Holland Linguistic Series, Elsevier, pp.287-296
- Rizzi, L. (2001b) *Locality and Left-Periphery*, ms., University of Siena
- Roberts, I. (1993a) *Verbs and Diachronic Syntax*, Dordrecht – Kluwer Academic Publishers

- Roberts, I. (1993b) “The Nature of Subject Clitics in Franco-Provençal Valdostain”, in *Syntactic Theory and the Dialects of Italy*, Turin - Rosenberg & Sellier, pp.319-353
- Sadock, J. & A.Zwicky (1985) “Speech act distinctions in syntax” in T.Shopen (ed.) *Language Typology and Syntactic Description*, Cambridge University Press, Cambridge, pp.155-196
- Speas, P. & C. Tenny (2002) “Configurational properties of point of view roles”, in A.M. Di Sciullo (ed.) *Asymmetry in Grammar, Vol.1: Syntax and Semantics*, John Benjamins, Amsterdam, pp. 315-345
- Vicario, F. (1998) “Iussivo e ottativo: osservazioni contrastive tra friulano e italiano”, *Quaderni della grammatica friulana di riferimento*, 1:109-124
- Vinet, M.T. (1998) “*Tu-pas* as a Modifier of Event Relations in a Narrative Discourse” in *Studies on the Syntax of Central Romance Languages*, Universitat de Girona, pp.243-255
- Vinet, M.T. (2000) “Feature Representation and *-tu(pas)* in Quebec French”, *Studia Linguistica* 54.3: 381-411
- Zanuttini, R. & P.Portner (2000) “The Characterization of Exclamative Clauses in Paduan”, in N.Munaro (ed.) *Quaderni di lavoro dell’ASIS 3: Frasi esclamative e strutture correlate*, Istituto di Fonetica e Dialettologia – CNR, Padua

The series is intended to make the work of the students, faculty and visitors of the *Dipartimento di Scienze del Linguaggio* of the University of Venice available for circulation.

The series can be obtained on an exchange basis with other Working Papers. Requests for single issues should be addressed directly to the authors.

1991 (out of print); **1992** (out of print); **1993**, voll. **3.1** and **3.2** (out of print); **1994**, voll. **4.1** and **4.2** (out of print); **1995**, voll. **5.1** and **5.2** (out of print); **1996**, voll. **6.1** and **6.2** (out of print); **1997**, vol. **7.1-2** (out of print); **1998**, voll. **8.1** and **8.2** (out of print).

1999. vol. 9, n. 1-2:

1. P. Acquaviva: Allomorphy and morphosyntax in Irish prepositional inflection.
2. A. Cardinaletti: Italian Emphatic Pronouns are Postverbal Subjects.
3. G. Cinque: The Status of "Mobile" Suffixes.
4. G. Giusti: The Functional Structure of Noun Phrases: A Bare Phrase Structure Approach.
5. J.-E. Lee: Korean Adverbs.
6. N. Munaro and H.G. Obenauer: On Underspecified *Wh*-elements in Pseudo-interrogatives.
7. S. Vecchiato: On the Relative Position of *beaucoup*, *guère*, *peu*, *rien*, and *trop* in Freknch.

2000. vol. 10, n. 1:

1. G. Cinque: A Note on Mood, Modality, Tense and Aspect Affixes in Turkish.
2. A. Giorgi and F. Pianesi: Ways of Terminating.
3. N. Munaro: Free relatives as defective *wh*-elements: Evidence from the North-Western Italian.
4. H.G. Obenauer and C. Poletto: "Rhetorical" *wh*-phrases in the left periphery of the sentence.
5. S. Pozzobon: Some Notes on the Distribution of Japanese Adverbs.

2000. vol. 10, n. 2:

1. A. Cardinaletti and G. Giusti: "Semi-lexical" motion verbs in Romance and Germanic.
2. G. Cinque: On Greenberg's Universal 20 and the Semitic DP.
3. A. Giorgi and F. Pianesi: *Imperfect Dreams*: The temporal dependencies of fictional predicates.
4. C. Poletto and J.-Y. Pollock: On the Left Periphery of Some Romance *Wh*-Questions.

2001. vol. 11:

1. A. Cardinaletti: Against Optional and Null Clitics. Right Dislocation vs. Marginalization.
2. G. Cinque: "Restructuring" and Functional Structure.
3. A. Giorgi and F. Pianesi: The Temporal Coordinates of Subject and Speaker: from Semantics to Morphosyntax.
4. N. Munaro: Splitting subject clitic-verb inversion.

2002. vol. 12:

1. G. Cinque: A Note on Restructuring and Quantifier Climbing in French.
2. A. Giorgi and F. Pianesi: Sequence of Tense and the Speaker's Point of View: Evidence from the Imperfect.
3. G. Giusti: Possessives in Old Italian.
4. I. Krapova: On the Left Periphery of the Bulgarian sentence.
5. M. Martínez-Atienza: Aspectual Interpretation in Spanish of Adverb-Modified Verbal Forms.
6. G. Turano: On Modifiers preceded by the Article in Albanian DPs.

2003. vol. 13:

1. A. Cardinaletti: On the Italian repetitive prefix *ri-*: Incorporation vs. cliticization.
2. G. Cinque: Issues in Adverbial Syntax.
3. V. Egerland: Impersonal *Man* and Aspect in Swedish.
4. A. Giorgi and F. Pianesi: On some anaphoric temporal locutions.
5. N. Munaro and C. Poletto: Sentential Particles and Clausal Typing in the Veneto Dialects.
6. G. Turano: Similarities and differences between standard Albanian and Arbëresh numerals. A case of micro-parametric variation.

2004. vol. 14:

1. A. Cardinaletti and L. Repetti: Clitics in Northern Italian Dialects: Phonology, Syntax and Microvariation.
2. A. Giorgi: Long Distance Anaphors and the Syntactic Representation of the Speaker.
3. G. Giusti and G. Turano: Case assignment in the pseudo-partitives of Standard Albanian and Arbëresh. A case for micro-variation.
4. Walter Schweikert: The Order of Prepositional Phrases.

2005. vol. 15:

1. P. Chinellato: Lexicalising functional heads in the 'AgrS-field': evidence from the 'A-morpheme' in Veneto dialects.
2. G. Cinque: A Note on Verb/Object order and Head/Relative clause order.
3. A. Giorgi and F. Pianesi: Credo (I Believe): Epistemicity and the syntactic representation of the speaker.
4. K. Haeng Soon: On the adjective in Korean.
5. I. Krapova and G. Cinque: On the order of wh-phrases in Bulgarian multiple wh-fronting.
6. W. Schweikert: The position of prepositional modifiers in the adverbial space.

2006. vol. 16:

1. G. Cinque: Two Types of Appositives.
2. M. Coniglio: German Modal Particles in the Functional Structure of IP.
3. A. Giorgi: A Syntactic Way to Subjunctive.
4. S. H. Kang: The Two Forms of the Adjective in Korean.
5. V. Laskova: On the Order of the Prenominal Participles in Bulgarian.
6. N. Munaro: Verbless Exclamatives across Romance: Standard Expectations and Tentative Evaluations.

2007. vol. 17:

1. M. Brunelli: LIS – Antisymmetry and split CP.
2. A. Cardinaletti: On different types of clitic clusters
3. G. Cinque: The fundamental left-right asymmetry of natural languages.
4. M. Coniglio: German Modal Particles in Root and Embedded Clauses.
5. F. Costantini: Subjunctive and SOT.
6. F. Del Gobbo: A Comparison between Japanese and Chinese Relative Clauses.

2008. vol. 18:

1. L. Brugè and A. Suñer: Building up Complex Temporal Constructions.
2. G. Cinque and I. Krapova: The two "possessor raising" constructions of Bulgarian.
3. M. Coniglio: Modal particles in Italian.
4. F. Costantini: Movement or Control? Some Hints from Floating Quantification
5. A. Giorgi: Crosslinguistic variation and the syntax of tense
6. C. Poletto: The syntax of focus negation