

Kraft Lignin: A Valuable, Sustainable Resource, Opportunities and Challenges

Dimitris D. S. Argyropoulos,^{*,[a]} Claudia Crestini,^{*,[b]} Christian Dahlstrand,^[c] Erik Furusjö,^[d, e] Claudio Gioia,^[f] Kerstin Jedvert,^[g] Gunnar Henriksson,^[h] Christian Hulteberg,^[i] Martin Lawoko,^[h] Clara Pierrou,^[j] Joseph S. M. Samec,^{*,[c, j, k, l]} Elena Subbotina,^[m] Henrik Wallmo,^[n] and Martin Wimby^[n]



Kraft lignin, a by-product from the production of pulp, is currently incinerated in the recovery boiler during the chemical recovery cycle, generating valuable bioenergy and recycling inorganic chemicals to the pulping process operation. Removing lignin from the black liquor or its gasification lowers the recovery boiler load enabling increased pulp production. During the past ten years, lignin separation technologies have emerged and the interest of the research community to valorize this underutilized resource has been invigorated. The aim of this

Review is to give (1) a dedicated overview of the kraft process with a focus on the lignin, (2) an overview of applications that are being developed, and (3) a techno-economic and life cycle assessments of value chains from black liquor to different products. Overall, it is anticipated that this effort will inspire further work for developing and using kraft lignin as a commodity raw material for new applications undeniably promoting pivotal global sustainability concerns.

1. Introduction

Plant cell based fibers are an integral component of modern society by being the raw material for numerous vital products, such as timber, paper, board, textiles, plastics and chemicals. As a renewable resource, the demand for wood based fibers, in particular, is predicted to increase. The associated technologies to yield these products fundamentally transform lignocellulosic feedstocks, mostly wood, into released cells (fibers) with various degrees of delignification.^[1] Compared to mechanical pulping, chemical pulping is more energy-efficient and offers fibers with a higher cellulose content suitable for a large spectrum of applications.^[2] Consequently, the share of chemical pulping has increased while mechanical pulping processes have seen a decline. One of the first chemical pulping technologies that was commercialized was sulphite pulping. In this, various metal or ammonium sulphites are used at neutral or slightly acidic

conditions to partly hydrolyse hemicellulose and transform most of the lignin into lignosulfonate, which is solubilized to release the cellulose fibers.^[3]

Kraft pulping (or otherwise known as sulphate pulping), was developed by the Swedish inventor Carl F. Dahl. The first kraft pulp mill was built in Sweden in 1890.^[4] Currently, kraft pulping is globally the dominant pulping technology and accounts for 90% of chemical pulping.^[5] This is both because the product is of higher quality for most applications and the production costs are lower.^[6,7]

In the early days the chemical recovery system of kraft pulping was primitive with considerable chemical losses. However, since Tomlinson's discovery of the recovery boiler the process chemicals are regenerated by using kraft lignin, that acts as a reducing agent, for sulphur via the interaction of pyrolysis gases with elementary carbon. Today, the recovery boilers are so efficient that all modern mills generate an energy

[a] Prof. Dr. D. D. S. Argyropoulos
Departments of Chemistry and Forest Biomaterials
North Carolina State University
431 Dan Allen Drive, Raleigh North Carolina 27695 (USA)
E-mail: dsargyro@ncsu.edu

[b] Prof. Dr. C. Crestini
Department of Molecular Sciences and Nanosystems
Ca' Foscari University of Venice
Via Torino 155, 30170 Venezia-Mestre (Italy)
E-mail: claudia.crestini@unive.it

[c] Dr. C. Dahlstrand, Prof. Dr. J. S. M. Samec
Ren Fuel K2B AB
Rapskatan 25, SE-754 50 Uppsala (Sweden)

[d] Prof. Dr. E. Furusjö
Division of Bioeconomy and Health
RISE Research Institutes of Sweden
Lindholmspiren 7 A, SE-41756 Göteborg (Sweden)

[e] Prof. Dr. E. Furusjö
Division of Energy Science
Luleå University of Technology
Universitetsområdet Porsön, SE-971 87 Luleå (Sweden)

[f] Dr. C. Gioia
Department of physics
University of Trento
Via Sommarive 14, 38123 Trento (Italy)

[g] Dr. K. Jedvert
Division of Materials and Production
RISE Research Institutes of Sweden
Lindholmspiren 7 A, SE-41756 Göteborg (Sweden)

[h] Prof. Dr. G. Henriksson, Prof. Dr. M. Lawoko
Wallenberg Wood Science Center (WWSC), KTH
Royal Institute of Technology
100 44 Stockholm (Sweden)

[i] Prof. Dr. C. Hultberg
Department of Chemical Engineering, Faculty of Engineering
Lund University
221 00 Lund (Sweden)

[j] C. Pierrou, Prof. Dr. J. S. M. Samec
RenFuel Materials AB
Rapskatan 25, SE-754 50 Uppsala (Sweden)

[k] Prof. Dr. J. S. M. Samec
Department of Organic Chemistry
Stockholm University
Svante Arrhenius väg 16 C, 10691 Stockholm (Sweden)
E-mail: joseph.samec@su.se

[l] Prof. Dr. J. S. M. Samec
Department of Chemistry, Faculty of Science
Chulalongkorn University
Pathumwan, 10330 Bangkok (Thailand)

[m] Dr. E. Subbotina
Center for Green Chemistry and Green Engineering
Yale University
370 Prospect St, New Haven, CT 06511 (USA)

[n] Dr. H. Wallmo, M. Wimby
Valmet AB
Regnbågsgatan 6, 41755 Göteborg (Sweden)

© 2023 The Authors. ChemSusChem published by Wiley-VCH GmbH. This is an open access article under the terms of the Creative Commons Attribution Non-Commercial NoDerivs License, which permits use and distribution in any medium, provided the original work is properly cited, the use is non-commercial and no modifications or adaptations are made.

surplus.^[8] The excess energy can be transformed into electricity and sold to the grid. However, since the recovery boiler is the most demanding unit of a mill, from a capital expenditure (CapEx) point of view, producing electricity at low efficiency (15%) is not an economically sustainable solution.^[9] Nevertheless, it is rather common that kraft mills sell excess heat to surrounding habitats and other industries.

Alternate ways to utilize the excess energy potential of a pulp mill is to extract a portion of the lignin from the black liquor prior to combustion and/or divert a fraction of it to gasification. Black liquor gasification could potentially be used to produce synthesis gas (Syngas) which can be further upgraded to a spectrum of derivative chemicals while still recovering the pulping chemicals, essential for the mill operation *vide infra*.^[10,11]

Since the recovery operation is often the bottleneck of the kraft process, lignin separation has been implemented in a few pulp mills to maintain or increase pulp production. At present, the precipitated lignin is mostly used as a solid fuel, for example, in the lime kiln of the pulp mill, where it can replace fossil fuels. However, kraft lignin is also a renewable source of a phenolic polymer.^[12,13] The fact that kraft lignin is currently a marketed commodity, ways to add value to it, beyond its energy value are intensely investigated, potentially offering an enormous boost to the sustainability of the kraft process.^[14]

The aim of this Review is to expose and critically examine the value chain of kraft lignin: from its generation to potential applications.^[15] This includes (1) a description of the kraft

process; (2) molecular details of kraft lignin and their dependence from the kraft and the extraction processes; (3) current technologies available for the isolation of kraft lignin from black liquor; (4) potential applications for kraft lignin, including liquid fuel and material applications; and (5) techno economic analysis (TEA) and life cycle assessment (LCA) over value chains. Overall, it is anticipated that this review will promote a deeper understanding of the potential of this renewable resource and expose the challenges associated with its availability, molecular structure and the techno economics and of the processes. Finally it is to be noted that this effort is distinct to the 'lignin-first' approach that focuses on controlling the reactivity of lignin upon its extraction via stabilization strategies, preserving native features that enable the use of lignin species for chemical production as a result, for which several excellent reviews exist,^[12,16,17] recently also upgrading the cellulose.^[18] The structure of native lignin is not covered and we recommend interested readers to any of the excellent reviews written on this topic.^[12,16,19]

1.1. Kraft process

During pulping, wood chips are exposed to white liquor consisting of sodium hydroxide and sodium hydrosulfide at $> 160^\circ\text{C}$.^[4] Under these conditions the lignin is partly depolymerized and significantly separated from the carbohydrate matrix via solubilization.^[7] The process produces unbleached



Dimitris S. Argyropoulos is a Professor of Chemistry at the departments of Chemistry & Forest Biomaterials, North Carolina State University. He has served as the Finland Distinguished Professor of Chemistry with the University of Helsinki & visiting Distinguished Professor with the Centre of Excellence for Advanced Materials Research, KAU, Jeddah, Saudi Arabia. He is a Fellow of the Royal Society of Chemistry, International Academy of Wood Science & Canadian Institute of Chemistry. His group focuses on the organic chemistry of wood components and the development of novel analytical methods and new chemistries for transforming the carbon sequestered in trees, producing valuable chemicals, materials, and energy.



Claudia Crestini received her PhD in 1996 from the University of the University of Tuscia, Viterbo, Italy. From 1995 to 1997 she was visiting scientist at McGill University in Montreal, Canada. She has been assistant and associate professor at the Tor Vergata University of Rome, Italy, since 1998 and, since 2018 she is professor in Chemistry at the Department of Molecular Sciences and Nanosystems, Ca' Foscari University of Venice, Italy. Her scientific activities focus on the field of lignin and natural polyphenolics valorization: nanoparticles, nanocapsules, nanofibers and their derived materials, structural characterization, catalysis, biomimetic catalysis, and biotechnology in lignin oxidative modifications.



Joseph Samec received his Ph.D. from the University of Stockholm, Sweden, in 2005 with Prof. Bäckvall as supervisor. After a postdoctoral training with Prof. Grubbs at CalTech, USA, during 2006–2007, he was appointed as Assistant Professor at University of Uppsala in Sweden. In 2015 he moved to Stockholm University where he is currently professor. His research interests focus on green chemistry in organic synthesis and biomass processing and applications. 2012 he founded RenFuel, a start-up company that is producing biofuels from lignin; and then 2015 RenCom and 2018 RenFuel Materials that produce materials from lignin.

kraft pulp and black liquor (Figure 1). The weak black liquor contains the dissolved lignin, water, various sulphur species (remaining hydro sulphide, thiosulphates, sulphates and some organic sulphur), other salts, dissolved organic material (extractives, formaldehyde, methanol, and a multitude of degradation products of carbohydrates and lignin).^[14] The dry solids content of the weak black liquor is around 15% w/w and this is eventually concentrated by evaporation to 70–80% w/w to give the strong black liquor. After evaporation, the liquor is introduced in the recovery boiler. Within this vital unit of the pulp mill, energy and pulp chemicals are recovered. The recovery boiler's design and careful operation uses an excess of oxygen in its upper part (where combustion of the organics takes place), while reducing conditions, created by pyrolysis gases and elemental carbon, operate in its lower part. In the lower zone, the chemicals present in the spent pulping liquor form sodium sulfide and sodium carbonate, create a smelt that is discharged from the boiler floor to a dissolving tank below the boiler, where the molten chemicals are dissolved in water to form the green liquor. After filtration, the green liquor is converted (causticized) to white liquor by reacting the sodium carbonate with a mixture of calcium oxide and calcium hydroxide (lime) to form sodium hydroxide. The calcium oxide is then regenerated in the lime kiln. After filtration of the solid calcium carbonate, the white liquor, that contains all required active species again, is ready for use in subsequent pulping operations thereby closing the chemical cycle of the kraft pulping process.

Although the processing of the pulping chemicals in the recovery boiler consumes a part of the energy content in the organic fraction of the black liquor, the boiler produces a large amount of energy (as steam) enough to provide energy for the whole heat and power consumption of the pulping process as well as export excess energy. Lignin is the main energy carrier in black liquor. Close to 100% of the kraft lignin in the world is combusted in recovery boilers. As mentioned, modern pulp mills are more than self-sufficient with respect to energy. With further energy efficiency improvements in the pulping process, more lignin can thus be used for other purposes.

2. Lignin Reactivity During Kraft Pulping

Kraft pulping subjects wood to rather harsh reaction conditions including high temperatures (> 160 °C), over a 2–3 h reaction time and strongly alkaline conditions in the presence of strong hydroxide and hydrosulfide nucleophiles. The process is relatively specific in fragmenting and solubilizing lignin as well as causing partial degradation of the hemicelluloses. The sulfide attacks lignin and also linkages between lignin and carbohydrates within the so called lignin carbohydrate complexes (LCC) and this liberates lignin, *vide infra* (Figure 2).^[20] Its effect, however, on the cellulose is minor eventually offering a rather strong fibrous product. The fragments of lignin that are liberated from the carbohydrate matrix, once in solution, undergo further reactions that eventually generate what is called kraft lignin.

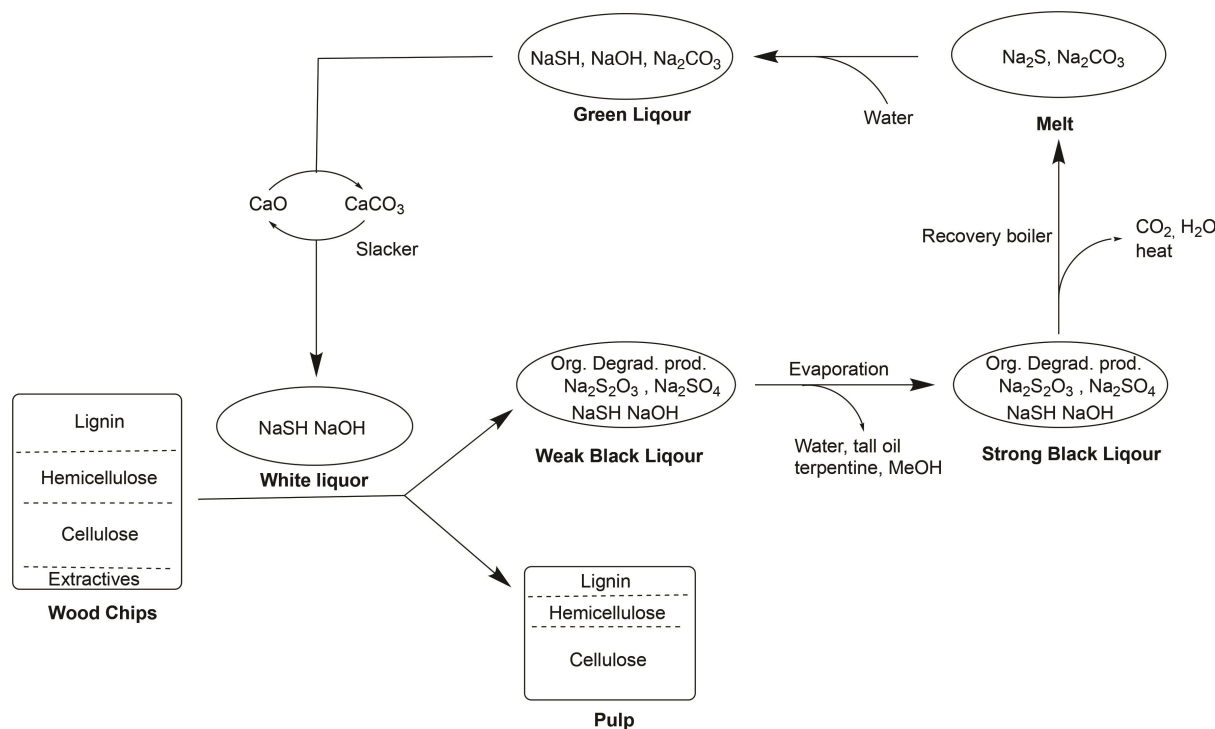

Figure 1. Simplified illustration over the kraft process. Sulfide and hydroxide ions are reactants in white liquor during the process. Weak black liquor is generated and concentrated during evaporation to yield strong black liquor. In the recovery, mainly lignin-derived organics operate as reducing agents to yield the smelt comprising of sodium sulfide and carbonate. Dissolution of the smelt in water gives the green liquor. Ion exchange in the lime kiln gives back the white liquor.

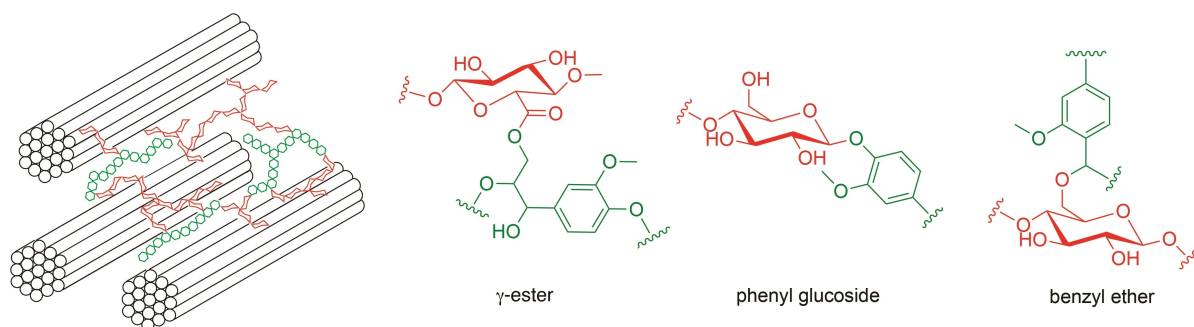

Figure 2. A proposed molecular representation of three fibrils that are connected via hemicellulose and lignin in the cell wall; LCC linkages.^[20]

The variability of the structure of kraft lignin is dictated by both the species and the seasonal variability of the feedstock as well as the severity of the treatment, termed the H-index: that significantly can vary depending on the nature of the starting feedstock and the desired pulp grade. The kraft lignin can eventually be isolated from the black liquor by precipitation upon acidic treatment by, for instance, CO_2 . This implies that the nature of the isolated kraft lignin is highly variable according to the specific reaction conditions, and it depends upon the severity of the delignification process. Furthermore, some pulp mills mix bleaching effluents with the black liquor before lignin precipitation, therefore, the final material is characterized by a high degree of variability and heterogeneity.

The harsh experimental conditions of kraft pulping induce a large variety of reactions in the structure of lignin. The structure of kraft lignin is heavily modified with respect to native lignin in the wood and to milled wood lignin (MWL) isolated from the same starting feedstock. From this viewpoint, the term "lignin" can even be considered misleading and needs to be re-defined, more appropriately as a class of molecules with a common denominator of aromatic building blocks. Consequently, the

elucidation of its structure is a challenging task that could be accomplished only by coupling modern nuclear magnetic resonance techniques, mass spectroscopic techniques, size exclusion chromatography analyses, etc., with an understanding of the chemistry for the delignification process.

During kraft pulping conditions lignin undergoes fragmentation and dissolution by a series of ionic reactions that yield to lignin fragmentation by cleavage of the $\beta\text{-O-4'}$ alkyl-aryl ether bonds.^[21–24] Apparently however, a number of radical redox steps occur on the released monomeric or oligomeric lignin fragments yielding recondensation processes along with fragmentation/reduction processes on the lignin side chain.

The most common lignin inter-unit in native lignin is the alkyl-arylether linkage ($\beta\text{-O-4'}$). This linkage is cleaved mainly by two different ionic mechanisms shown in Figure 3. A "slow sulfide independent reaction" occurs mainly on non-phenolic structures and gives an "endo-depolymerization" process^[24,25] that is initiated by the deprotonation of the α hydroxy group followed by intramolecular nucleophilic substitution to generate an intermediate epoxide and cleave the aryl alkyl ether bond (Figure 3A). The main reaction pathway is a "fast sulfide

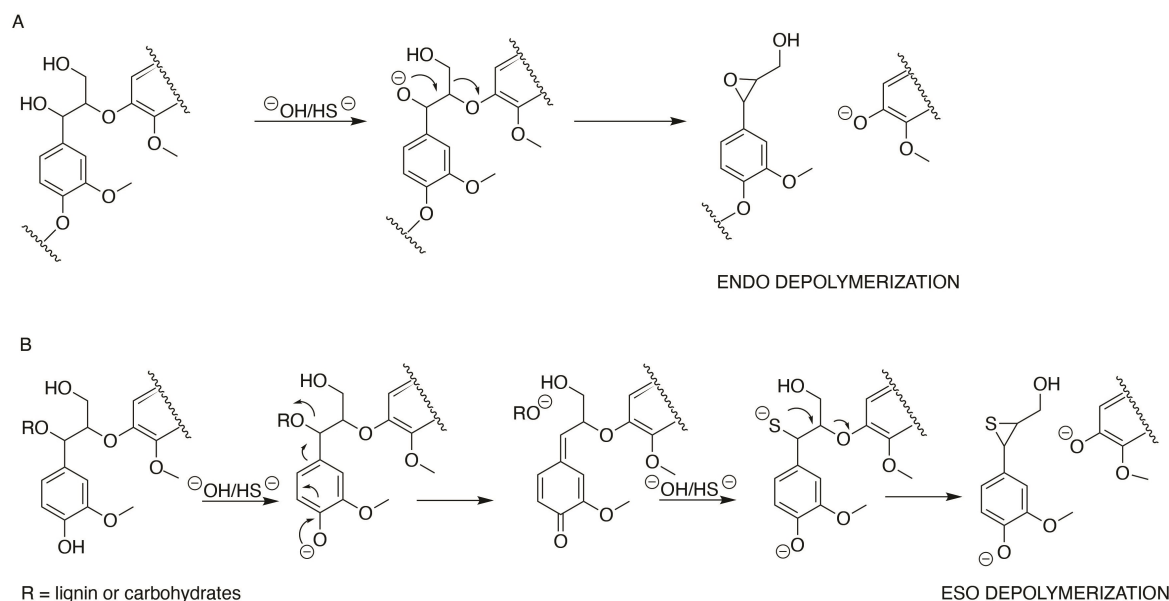

Figure 3. Cleavage of non-phenolic and phenolic $\beta\text{-O-4}$ bonds during kraft pulping. A) slow sulfur-independent reaction; B) fast sulfur-dependent reaction.^[26,29]

dependent reaction" (Figure 3B) that occurs at the phenolic end-units,^[22] which under kraft pulping conditions are in the form of phenolate anions, by the formation of a key quinone methide intermediate and by elimination of the C α hydroxy group. The quinone methide in turn undergoes nucleophilic attack from the highly nucleophilic hydrosulfide anion, followed by intramolecular nucleophilic substitution yielding an episulfide intermediate and the cleavage of the β -O-4' aryl ether bond which ultimately result in lignin "esodepolymerization".^[4,20,26-28]

The key step of lignin modification/depolymerization in kraft pulping chemistry is the formation of the quinone methide from phenolic end groups by oxidation. This intermediate undergoes nucleophilic hydrosulfide attack followed by cleavage of β -O-4' interunit units (Figure 4A). Alternatively, loss of formaldehyde from phenolic aryl enol ether end-groups occur (Figure 4B).^[30] The formation and reactivity of the intermediate quinone methide is also responsible for the fate of phenyl coumarans (β -5') and β -1 lignin substructures. Differently from the reactivity of the β -O-4' interunit bondings, quinone methides generated from β -5' and β -1' units, Figure 4C, undergo formaldehyde loss to generate stilbene end units and do not undergo further depolymerization.^[26]

Kraft lignin contains a notably low amount of lignin side chains: the oxygenated aliphatic carbons are lower than the aromatic units with respect to the common ratio found in native like lignin preparations such as milled wood lignin (MWL).^[31,32] This implies the occurrence of side chain fragmentation pathways. More specifically, C1-C α cleavage occurs under

alkaline conditions at the lignin terminal phenolic units by retro aldol reactions with the formation of monomeric phenols. (Figure 4D).^[26,29] Notably, such monomeric phenolic compounds, that are devoided of the original lignin side chain can further react. Furthermore, monomeric and polymeric phenols with or without the original or modified aliphatic side chain, generated during kraft pulping in the black liquor, undergo significant demethylation reactions at the aromatic C3 position, thus generating catechols along with methyl mercaptan and dimethyl sulfide (Figure 4E) responsible for the odour of kraft pulp mill operations.^[26,29]

The description so far might indicate that practically all lignin could be removed from the wood by depolymerization as described above. This is not the case in practice, and the main product, the pulp, contains 5–10% lignin. A variety of C–C linkages originally present in the lignin as well as others formed during kraft pulping together with a significant variety of unsaturated centers still remain in the residual lignin. To eliminate the final lignin, bleaching is required.^[33]

The presence of non-oxygenated aliphatic and two or one carbon side chain moieties in kraft lignin has also been well documented.^[29,34,35] Their origin has not been well clarified and still requires further elucidation. One possible explanation for their presence is the occurrence of complex radical redox reactions during kraft pulping. In fact, detailed studies of pulping chemistry showed the formation of radical sulphur species.^[36,37] Detailed structural characterization of kraft lignin as isolated from previously acetone extracted wood, unambiguously showed that the reduced non-oxygenated aliphatic chains

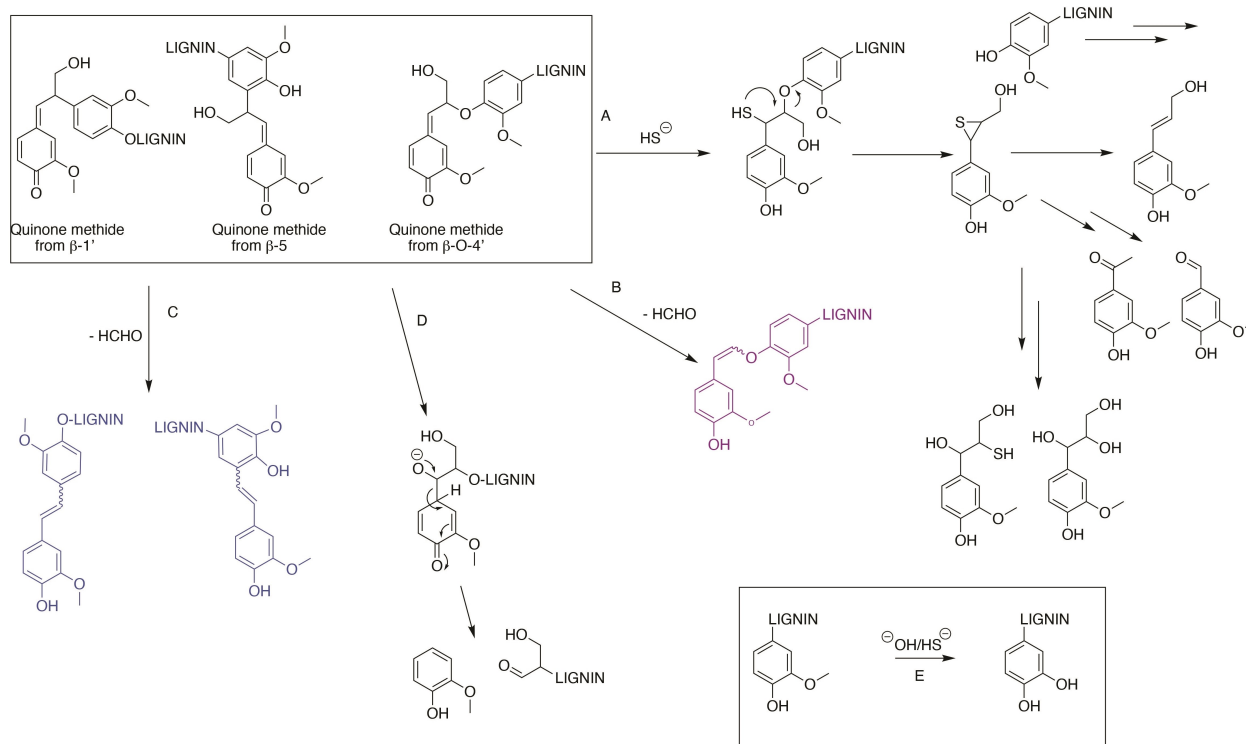

Figure 4. Key reactions from quinone methide intermediates during kraft pulping. A) Cleavage of the β -O-4' interunit units; B) elimination of formaldehyde to give stilbenes; C) elimination of formaldehyde from β -1 interunit; D) C1-C α cleavage through retro aldol condensation.

in kraft lignin are not arising from the presence of residual extractives.^[29] This implies the occurrence of complex redox reactions possibly mediated by sulphur-containing species, vide infra.

Detailed structural studies of kraft lignin show a high degree of branching with respect to the corresponding original lignin in the wood isolated as milled wood lignin (MWL). Data from permanganate oxidation qualitatively showed extensive branching.^[38] More recent studies were carried out by comparing the overall amount of aromatic carbons as revealed by quantitative ¹³C NMR with the amount of aromatic C–H bonds evaluated by Quick Quantitative Heteronuclear Single Quantum Correlated Spectroscopy QHSC. From these experiments emerged an approximate branching degree in kraft lignin of about 84%.^[29] Under harsh kraft pulping conditions, polysulfide, sulphur, thiosulfate and sulfate are generated from hydrosulfide.^[36] Therefore, the occurrence of radical redox reactions that cause oxidative coupling of phenols has a major impact on the final structure of kraft lignin and has to be taken into consideration along with ionic reactions.^[35,36,39,40,41] The monomeric, oligomeric and polymeric lignin fragments gener-

ated by the ionic pathways during pulping, therefore, undergo extensive complex reactions of radical oxidative coupling. This tremendously affects the structure of the lignin that emerges from this process. Such a reaction pathway explains the high branching degree in kraft lignins and details can be found in the following reference.^[29] Figure 5 reports previously hypothesized radical repolymerization reaction pathways. Furthermore, a wide variety of aliphatic signals can be detected in the HSQC spectra of kraft lignins, among which there are arylacetic acid, aryl-hydroxy-acetic acid, aryl ethyl ketone, aryl propanol and aryl hydroxyethyl ketone signals. Such aliphatic moieties possibly arise from the above mentioned redox processes.^[29,37] In fact it has been unambiguously demonstrated that they are not related to the presence or to the reaction of extractable aliphatics in wood.

It is therefore easily predictable that kraft lignins are highly polydisperse polymers. They display rather low M_n and M_w value, ranging from 800 to 2000 in M_n and from 1700 to 6000 for M_w as reported in Table 1. These results show that a relevant fraction of the kraft lignins has a mass around 800 Da, which implies a degree of polymerization ranging from 1 to 6.^[42]

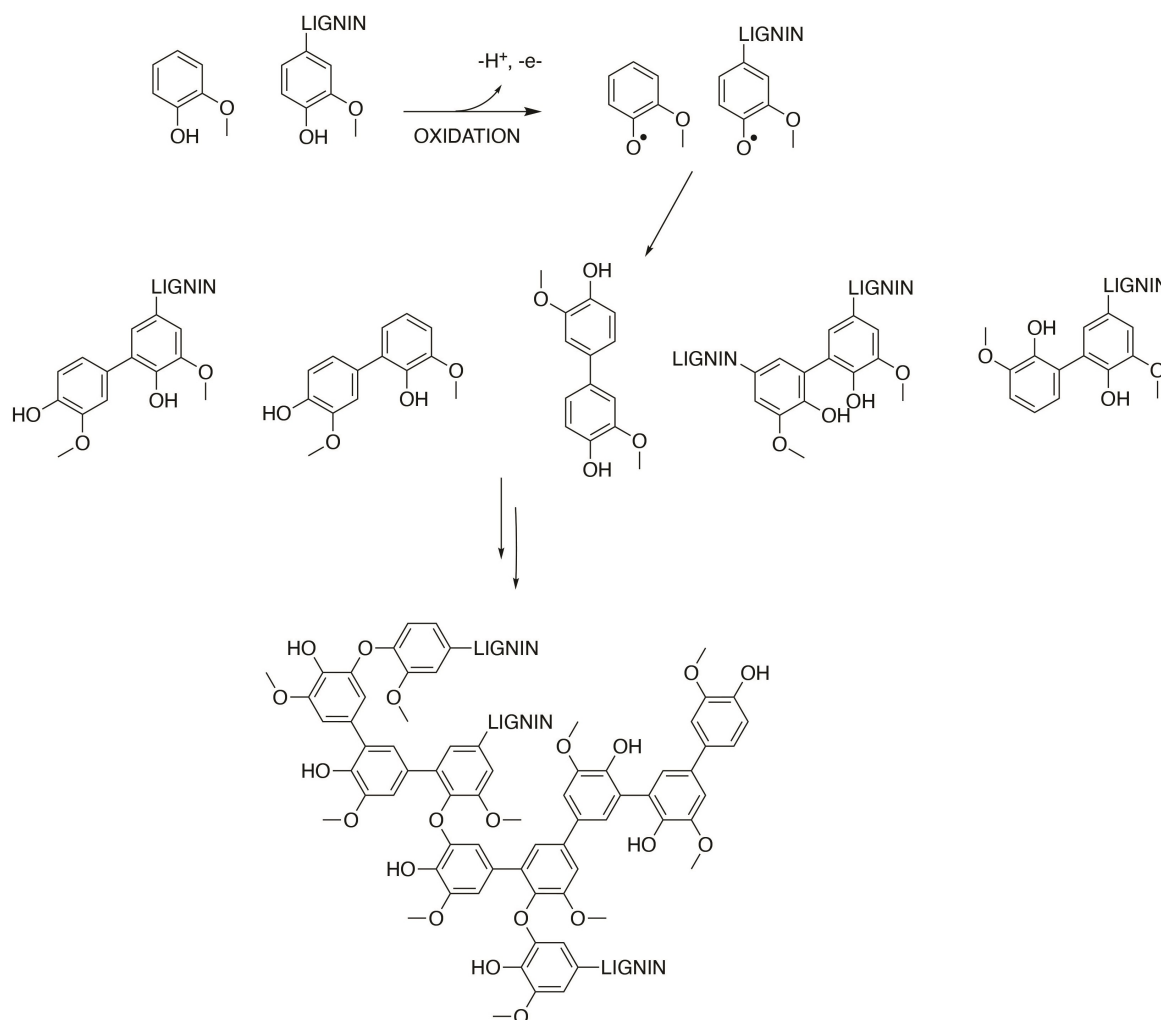

Figure 5. Possible radical oxidative coupling modes of lignin fragments released during kraft pulping. Reproduced from Ref. [29] Copyright (2017), with permission from Royal Chemical Society.

Table 1. Apparent molecular weight distribution in softwood and hardwood kraft lignins.

Sample	M_n	M_w	Method	Ref.
Softwood				
Softwood Kraft lignin	1600	3500	Osmometry	[43]
Softwood Kraft lignin	1710	2570	Maldi-TOF	[44]
Softwood Kraft lignin	1820	3100	GPC	[44]
Indulin AT	1200	2990	Maldi-TOF	[44]
Indulin AT	1340	3400	GPC	[44]
Softwood Kraft lignin	1400	6000	GPC	[29]
Hardwood				
European beech Kraft lignin	1044	1711	GPC	[45]
Eucaliptus kraft lignin	1273	4200	HPLC	[46]
Eucaliptus grandis kraft lignin	910	1740	GPC	[47]
Hardwood Kraft Lignin	1000	3900	HPLC	[48]
Hardwood Kraft Lignin	1000	3300	HPLC	[48]
Induline hardwood	1300	2700	GPC	[49]
Hardwood Kraft Lignin	1263	2400	GPC	[50]
Hardwood Kraft Lignin	1793	3290	GPC	[51]

The development of fractional precipitation techniques,^[59,66] *vide infra*, enabled kraft lignin samples that possess a high degree of homogeneity with respect to molecular weight, nature of functional groups and amounts. This in itself opened a new approach for the elucidation of kraft lignin structure. To this effect, an acetone soluble and an acetone insoluble as well as several acetone soluble fractions were obtained with varying molecular weight distributions. These were then structurally characterized by ³¹P NMR, ¹³C NMR, QQ-HSQC and GPC analyses. From this study a new structural scheme for kraft lignin emerged.¹ Kraft lignin appears to be composed of a high molecular weight acetone insoluble and a lower molecular weight acetone soluble fraction. The former is reminiscent of the original lignin structure in wood. It is, however, more branched and contains heavily modified side chains. More specifically, stilbenes and aryl enol ethers are present, while the β -O-4, phenyl coumaran and pinosresinol subunits are largely depleted. The aliphatic side chains are partially reduced and/or fragmented. This acetone-insoluble kraft lignin structure is anticipated to emerge via kraft pulping reactions and complex redox side chain reduction and fragmentation patterns. On the contrary, the acetone soluble kraft lignin fraction shows a polyphenolic structure largely devoided of oxygenated side chain that are characteristic of lignin. It is highly branched and contains a higher amount of phenolic groups with respect to the acetone soluble fraction. It possibly arises from extensive oxidative coupling of monomeric phenolic species released during pulping, as shown in Figure 4. A structure reflecting the different abundancies of the functional groups and degree of branching for softwood kraft lignin was recently proposed^[29] and is shown in Figure 6.

3. Kraft Lignin Supply-Related Data

Globally, about 75% of the total pulp produced is using the kraft process. In a given year about 170 million tonnes of kraft pulp are produced.^[33,53] To estimate the amount of available lignin that could be utilized for producing high-value products, if extracted, the lignin content in black liquor must be known. This figure will vary depending on several variables, e.g., raw material used (hardwood or softwood) or the type of product is produced at the mill. This gives above 70 million tonnes of lignin per year that could be made available to extract.^[54] The amount that can be extracted, depends on the energy demands of the mill (since part of the energy produced in the recovery boiler is used to produce pulp) varies from case to case. During the last 20 years, significant energy improvements have been made, and today most mills have an energy surplus. A 40% outtake of lignin would give a yearly lignin extraction potential of about 27 million tonnes of lignin from all the kraft pulp mills worldwide. The potential of lignin extraction for a large modern mill (1.5 mADt per year Air Dry Tonnes.) is thus around 450,000 tonnes of lignin per year, considering replacing the existing energy surplus with a lignin extraction plant.

There are two incentives for the pulp mill to recover lignin from black liquor (Figure 7): 1) If converted to a product of higher value than its energy value, a second product stream is generated. The focus of this review is to give examples of such value chains, *vide infra*. 2) The recovery boiler is the most CapEx intensive unit in a pulp mill. Thus, most pulp mills run with the recovery boiler as the bottleneck to produce pulp. Thereby, an outtake of lignin from the process increases the production of pulp. This increased pulp production termed "marginal tonnage" gives a profit to the mill. Therefore, lignin outtake both gives a new product as well as an increased production of pulp.

4. Kraft Lignin Outtake Strategies

A pulp mill can either recover the lignin as crude black liquor and this is advantageous in certain applications such as gasification, *vide infra*. Alternatively, lignin in the black liquor can be extracted by precipitation (Figure 8). The current technologies to industrially extract kraft lignin from the black liquor are as follows: Two of them, LignoBoost^[55] and LignoForce,^[56] use versions of acidification of the liquor to lower the solubility of the lignin followed by filtration (see below). Another approach also involves initial acidification, but instead of working with a cold black liquor, the liquor is maintained in the hot state, and the lignin separates as a liquid lignin organic phase from the liquor. The approach is oftentimes referred to as the sequential liquid-lignin recovery and purification (SLRP) method.^[57] These extraction technologies can be combined with different fractionation methodologies, *vide infra*.

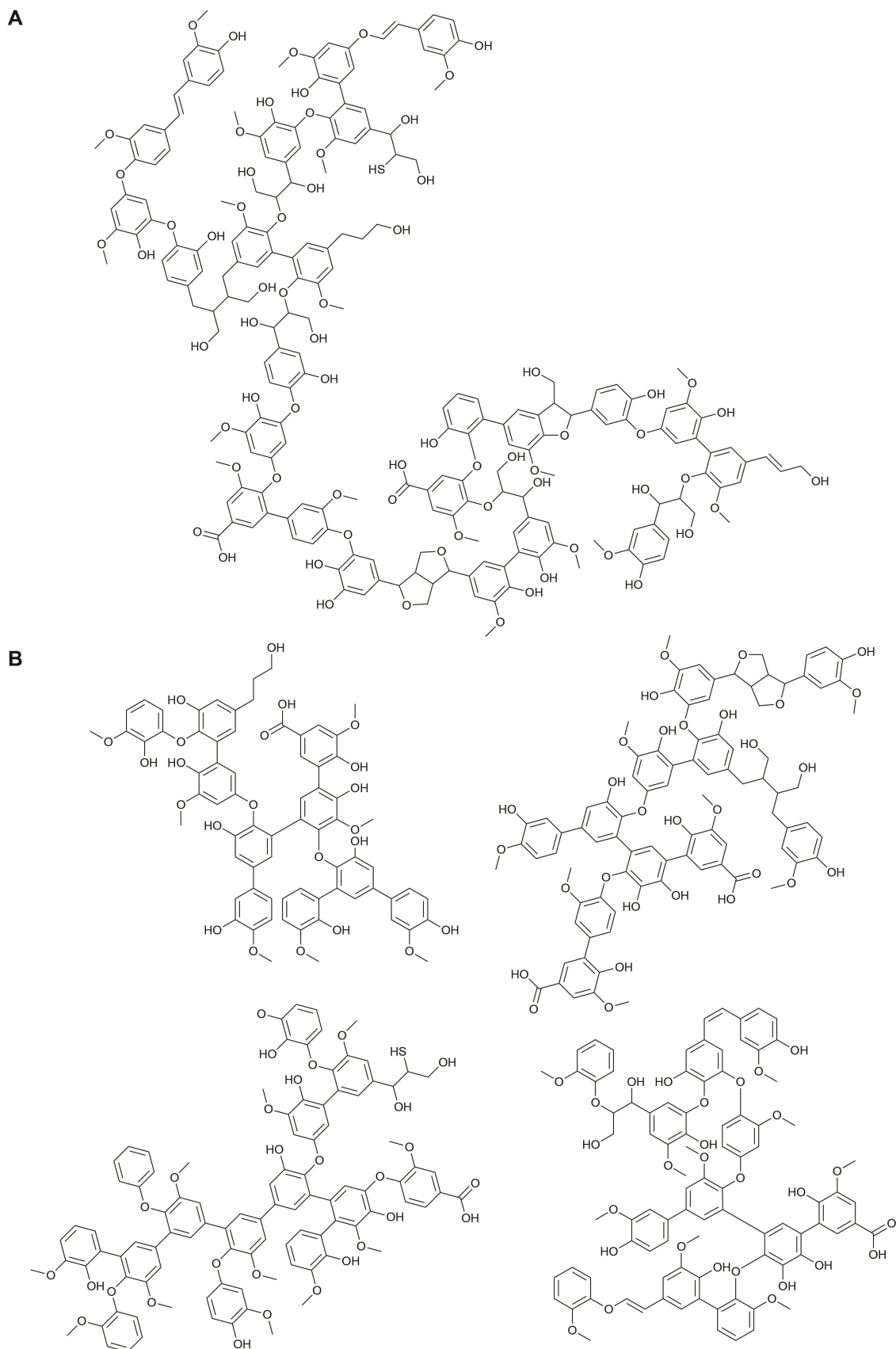

Figure 6. Proposed structure for softwood kraft lignin. A) large fractions with more native structure; B) phenol enriched smaller fractions. All the interunit bondings presented in the figure have been detected by specific analytical techniques. The substitution patterns in the highly condensed fraction B have been postulated on the basis of the degree of branching as evaluated by quantitative ^{13}C NMR and QHSQC. Reproduced from Ref. [29] Copyright (2017), with permission from Royal Chemical Society.

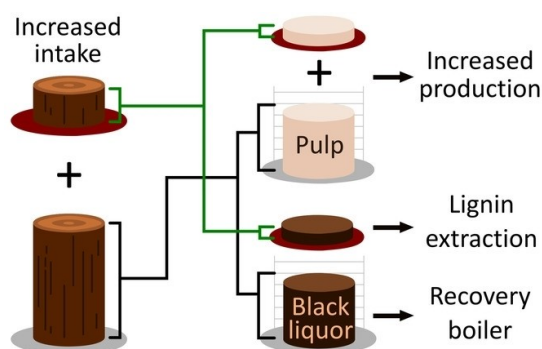

Figure 7. Representation of the two major advantages of recovering lignin from the black liquor: 1) lignin raw material that can be valorized; and 2) the concomitant increased production of pulp. The increased pulp production is sometime referred to as marginal tonnage. Reproduced from Ref. [53] Copyright (2021), with permission from Wiley-VCH.

4.1. LignoBoost

The LignoBoost process^[58] has been implemented in two commercial plants: Domtar, Plymouth in North Carolina, USA and Stora Enso, Sunila in Finland with a demonstration plant also operating in Bäckhammar, Sweden. The process consists of two acidification steps comprising precipitation and filtering (Figure 8a). Partially evaporated black liquor of dry substance content of about 40% is acidified with carbon dioxide, where the phenolic compounds in kraft lignin are protonated and

then are precipitated from the aqueous phase. The resulting slurry is filtered in a filter press to give a solid composed of moist lignin containing a high ash content. The resulting filter cake is then re-dispersed and acidified with sulphuric acid to protonate the lignin and to reduce its ash content to below 1 wt%. The slurry is filtered again to produce the final product. The liquors are recycled to the recovery boiler to regenerate the process chemicals. The final product has a moisture content of about 35% which can be further decreased.

4.2. LignoForce

This technology, while it is rather similar with the LignoBoost-process certain modifications that simplify the process and avoid the belt filtration have been implemented.^[56] In addition, the inventors claim reduced H₂S emissions, usually experienced with acidification since a pre-oxidation step is also applied prior to acidification. More specifically during the LignoForce procedure, the black liquor is initially oxidized, altering the particle-forming behavior of the lignin after being precipitated with carbon dioxide. This avoids the need for “two filtration stages”, which is now addressed with a single filter press, where the lignin also is washed and protonated with sulphuric acid. The produced lignin has similar properties as lignoboost lignin. Figure 8b shows a schematic description of the process.

a) LignoBoost

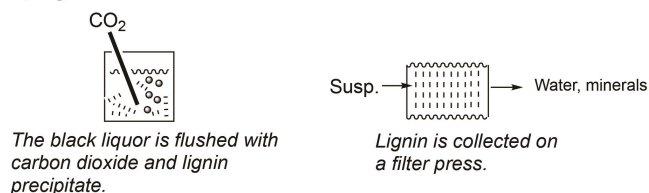

b) LignoForce

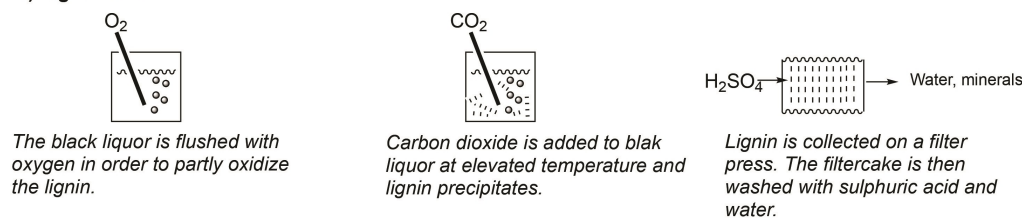

c) SLRP

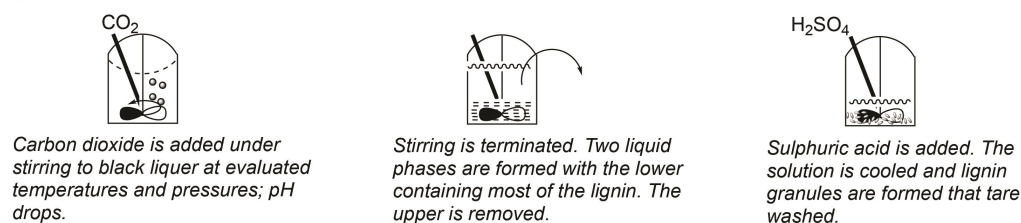

Figure 8. Lignin recovering techniques by precipitation: a) LignoBoost; b) LignoForce; c) SLRP. All three methodologies have in common that pH is reduced in a modulated manner which in combination with the associated technology developments protonate the abundant phenolic hydroxyls of the kraft lignin which is either precipitated (a, b) or phase separated in liquid form (c).

4.3. Sequential liquid lignin recovery and purification (SLRP)

In contrast to the methods described above, the black liquor is acidified using carbon dioxide under pressure and high temperature. Under these conditions, a phase separation occurs with the lignin forming a pseudo liquid phase that is separated from the liquor and is decanted. Further acidification with sulphuric acid forms granules. The produced toxic gases and related volatiles (H_2S , related mercaptans etc.) may then be re-introduced to the black liquor stream to be combusted in the recovery boiler.^[57] Figure 8c shows a schematic description of the process.

5. Fractionation of Lignin

Kraft lignin displays high variability and heterogeneity, mostly caused by the different processing conditions and isolation procedures. Higher severity treatments result in isolated kraft lignin with more significantly altered structures, while, on the other hand, the optional presence of an oxidation step in the isolation process for kraft lignin significantly changes the final distribution of the functional groups. For certain applications, there is a need to develop production processes that ensure the availability of a consistent and reproducible starting material with low polydispersity and a constant distribution of functional groups and as a consequence, of physicochemical properties. Hence, the development of fractionation processes with the final objective of obtaining "lignin cuts" with identical chemical physical characteristics from lignin arising from treatments of different severities and different isolation processes is of paramount relevance in the field. The different approaches undertaken in this direction can be categorized into pH, solvent, and membrane mediated fractionations as outlined schematically in figure 9.^[59]

5.1. Fractionation of kraft lignin in black liquor by varying pH

Kraft black liquor pH dependent fractional precipitation has been widely studied, where larger fragments generally precipitate at higher pH than smaller fragments.^[60,61] The structure of the lignin fractions obtained however, does not depend only upon the precipitation pH but also significantly on the pulping process details and the nature of the acid used.^[62–65] As a result, in comparison with solvent fractional precipitation, *vide infra*, the pH-dependent precipitation of black liquor gives less defined fractions. An advantage of the methodology is the ease of operation where a LignoBoost/Force set up is sufficient.

5.2. Solvent-mediated fractional precipitation of kraft lignin

In 2014 Argyropoulos and his team first reported the fractional precipitation of kraft lignin that offered reproducible lignin fractions. The method is essentially based on initially exposing

kraft lignin into a polar solvent such as acetone, creating an acetone soluble and an acetone insoluble fraction.^[66] The acetone soluble lignin can then fractionally precipitated by the addition of increasing amounts of a non-polar but miscible solvent such as hexane. The outcome of the process being a number of lignin fractions with low polydispersity index.

Theoretically, fractional precipitation may offer an infinite number of polymer fractions with the use of a continuous solvent gradient that involves two miscible organic solvents, one being a good solvent for a given polymer solution and the other being a poor solvent. The rationalization offered, for the fact that such highly uniform fractions of softwood kraft lignin can be created by fractional precipitation is due to the ability to gradually alter the polarity of the environment the lignin molecules are solvated. As the solvent composition varies, conditions of partial dissolution occur and the less solvated molecules precipitate out. As such, the uniformity, in terms of molecular weights and functional groups within each lignin fraction can be controlled based on the selection of the solvent gradient.

The most important implication of this process is that by tuning the solvent composition it is possible to obtain lignin fractions with the desired characteristics in terms of MW distribution and functional groups content. More specifically, low molecular weight fractions are associated with high phenolic and carboxylic acid, and low aliphatic OH content (see structure in Figure 6B). Furthermore, it was demonstrated that virtually identical fractions with respect to molecular weight and chemical structure can be isolated from kraft lignin arising from different sources and pulping protocols. This original work demonstrated a general applicability to lignin of different origins, initiated a huge effort in the field. Argyropoulos finding was soon confirmed by other studies.^[29,49,52,67,68] Other solvent systems have also been investigated such as dissolution in methanol/acetone and fractional precipitation in ethyl acetate or ethyl acetate/petroleum ether^[69] or by dissolution/precipitation in greener solvents.^[70–72] Another similar approach consists into the dissolution in ethanol and further precipitation by addition of increasing amounts of water as a non-solvent or by evaporation of the water originally present.^[73] In all cases all the fractions, that are obtained in different yields according to the solvent system chosen, display consistent characteristics irrespective of the starting kraft lignin.

An alternative solvent fractionation approach to the extraction into a single solvent is the sequential dissolution of kraft lignin into a series of solvents. Early attempts were focused on the use of solvent sequences with increasing Hildebrand solubility parameters.^[74,75] However, this approach does not allow the prediction of lignin solubility since the Hildebrand parameters do not consider the propensity to form hydrogen bonds. On the contrary, solvents sequences based on the Hansen solubility parameters that take into account hydrogen bonding, besides dipolar and non-polar interactions, were found to be more effective.^[76]

Single solvent extraction is a basic system to separate kraft lignin into two fractions with significantly different properties (Figure 9A).^[77] Irrespective of the solvent used for fractionation,

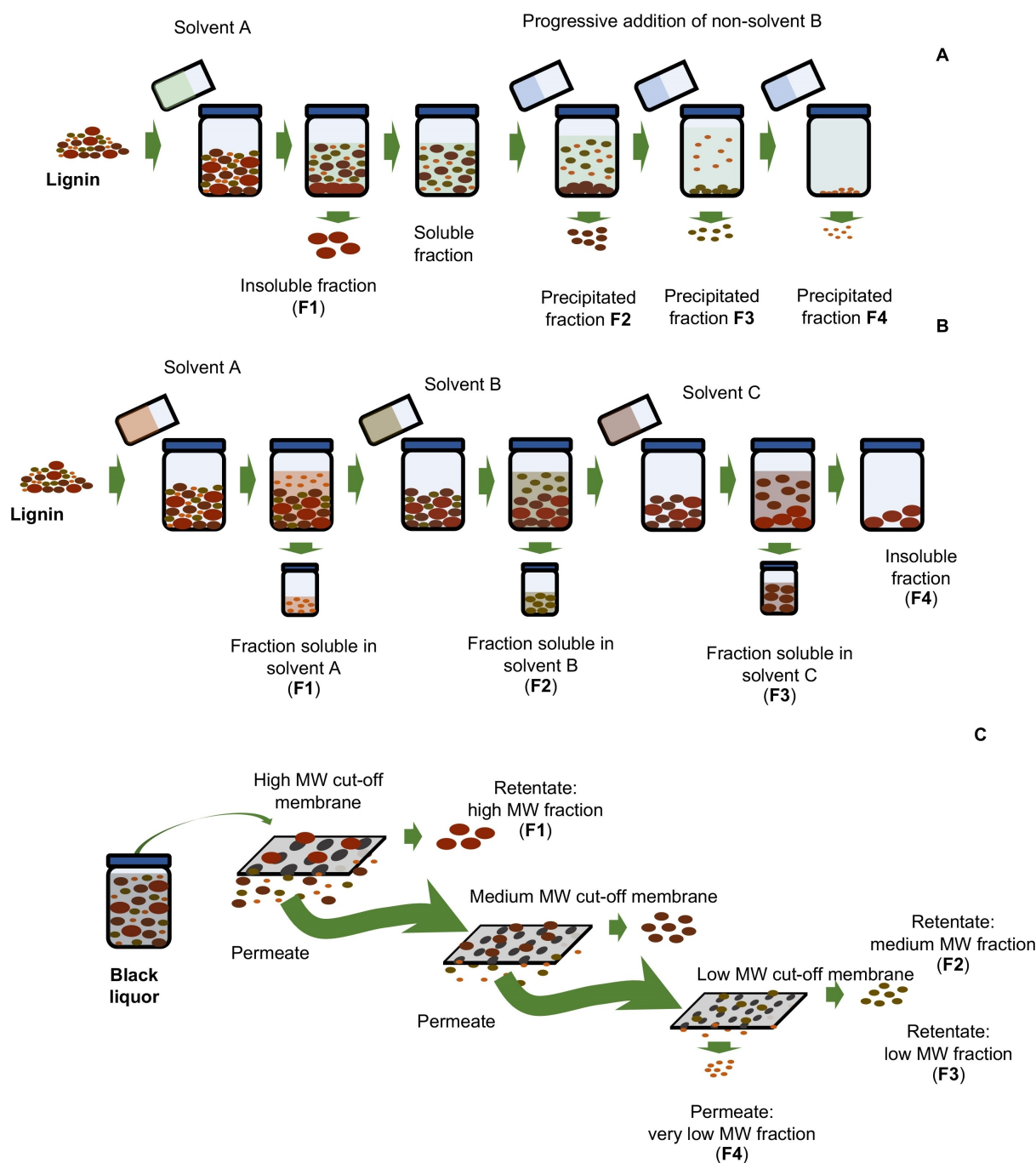

Figure 9. Schematic offering a pictorial representation of the different approaches used for kraft lignin fractionation. A) Sequential solvent precipitation; B) sequential solvent dissolution; C) membrane filtration. Solvent extraction fractionates lignin based on both molecular weight and polymer solvent interaction variable, while membrane filtration fractionates purely based on molecular weight. Reproduced from Ref. [59] Copyright (2020), with permission from the Royal Chemical Society.

there is a correlation between the glass transition temperature and the M_w of the fraction that fits the Fox equation,^[77] with lower M_w lignin fractions invariably showing higher glass-transition temperatures (T_g); furthermore, TGA studies showed that the soluble fractions are less stable than the insoluble ones.

Sequential solvent fractionation has been applied to a plethora of different solvents (Figure 9B), including green

solvents^[78–85] and shows a general trend: High M_w fractions contain higher amounts of β -O-4' interunit bonds and higher amounts of aliphatic OH groups, somehow reminiscent of the pristine lignin structure, while low M_w fractions have a higher content in phenolic and carboxylic groups associated with significant higher branching degree and a low content in the typical lignin structural motifs. With respect to possible scaling up of lignin fractionation, it is worth mentioning the develop-

ment of segmented flow fractionation processes that allow exhaustive extraction of specific lignin fractions with tunable solvent mixtures and solvent gradients, temperatures and pressures to optimize yields and fractions structural characteristics.^[86] The overall challenges with solvent-assisted fractionation are techno-economic and process sustainability considerations. These need to be examined on a case by case basis where variables such as product market drivers, nature and solvent recycling possibilities are coupled with holistic LCA and TEA analyses.

5.3. Membrane filtration of black liquor

To alter the concentration of lignin, or to separate the lignin into different molecular weight fractions, membranes of variable cut-offs can be used offering fractions even starting from black liquor (Figure 9C). The membranes may be of either ceramic or polymeric type, with the possibility to use the former at higher temperatures. When addressing black liquor filtration for lignin valorisation, two approaches may be taken. Either the lignin is concentrated by passing the liquor through a membrane to concentrate the lignin. This has the advantage of reducing the downstream volume of the lignin extraction/valorisation process. It is feasible to concentrate the lignin in the liquor to about 70–80% of the inlet concentration and thus return 70–80% of the cooking chemicals to the mill before any further handling. This is typically performed with a membrane with a molecular weight cut-off in the 1000–3000 Da range and lowers the potential impact on the mill chemical balance. It should be recognised that the lignin retained by the membrane is the one with high molecular weight. The other approach is to use the lignin molecules that pass through the membrane and thus have much lower molecular weight. The advantage of this method is that the lignin is more suitable to use as a chemical and petrochemical feed, but it has the disadvantage of a much more dilute lignin stream. The first approach makes lignin separation more straight-forward, and gives a concentrated lignin product with a large molecular weight. The second approach provides a diluted low-molecular-weight lignin, but is challenging from a post-separation perspective. It should be pointed out that the use of membranes does not provide separated lignin from the liquor. It only offers a method for changing the concentration of the lignin and the molecular size distribution. Various versions of the methods described above are still required for the actual separation of the lignin by precipitation using an acid. Membrane filtrations present some challenges including fouling, membrane cleaning and lifetime issues.^[87–90] Overall, such technologies have been applied industrially for lignosulfonates and a successful demonstration scale plant for black liquor.^[91]

6. Applications for Kraft Lignin

6.1. Kraft lignin in different fuel applications

6.1.1. Lime kiln fuel

The major current application of using precipitated kraft lignin is internal use as fuel in the lime kiln operation.^[58,92] Unfortunately, there is very little published on using lignin to power the lime kiln. A discussion about the TEA and LCA of this application is found in Sections 7 and 8.

6.1.2. Gasification

Gasification is the thermochemical process in which carbon-containing feedstocks are converted to synthesis gas (Syngas) at elevated temperatures using sub-stoichiometric amounts of typically oxygen, steam, or carbon dioxide. Most industrial gasification processes have been developed for fossil feedstocks but are increasingly being adapted and used for bio-based feedstocks.^[93] The main components of the synthesis gas are hydrogen and carbon monoxide, which can be upgraded to a multitude of fuels and platform chemicals using commercially available petrochemical process technologies (Figure 10).

Kraft lignin, isolated from black liquor, is a difficult feedstock to gasify due to its tendency to form solid char products, leading to poor synthesis gas yields.^[94] Consequently, the amount of published work, and commercial developments for its gasification, has been limited.^[95] Contrary to isolated kraft lignin, black liquor, containing dissolved lignin, a multitude of organic components and pulping chemicals, has been the subject to intense gasification research and development since the 1960s. Early on, the focus of black liquor gasification (BLG) research was on improving electricity generation efficiency via integrated gasification combined cycle (IGCC) applications. Several gasification technologies were developed in parallel, mostly based on fluidized bed technologies.^[96–98] During early parts of this century, however, the focus of related research changed toward the production of biofuels via Syngas upgrading.^[11,99] This emphasized the need to move from air-blown gasification to either oxygen-blown or indirect steam gasification, avoiding the presence of nitrogen in the Syngas. To this effect, Manufacturing and Technology Conversion International (MTCI) and later ThermoChem Recovery International (TRI) developed a low temperature (non-slugging) bubbling fluidized bed that was tested on a 50–200 t per day scale in three pulp mills in North America.

The Swedish company Chemrec developed an oxygen-blown entrained flow (EF) black liquor gasification process, whose functionality has been demonstrated on a pilot scale (3 MW) using kraft black liquor^[100–102] and spent pulping liquor from sodium-based sulfite delignification.^[103] EF gasification of black liquor and sulphite liquor is carried out under slugging conditions at 1000–1100 °C. The inorganic smelt (slag) leaving the gasifier is dissolved in water to form green liquor and

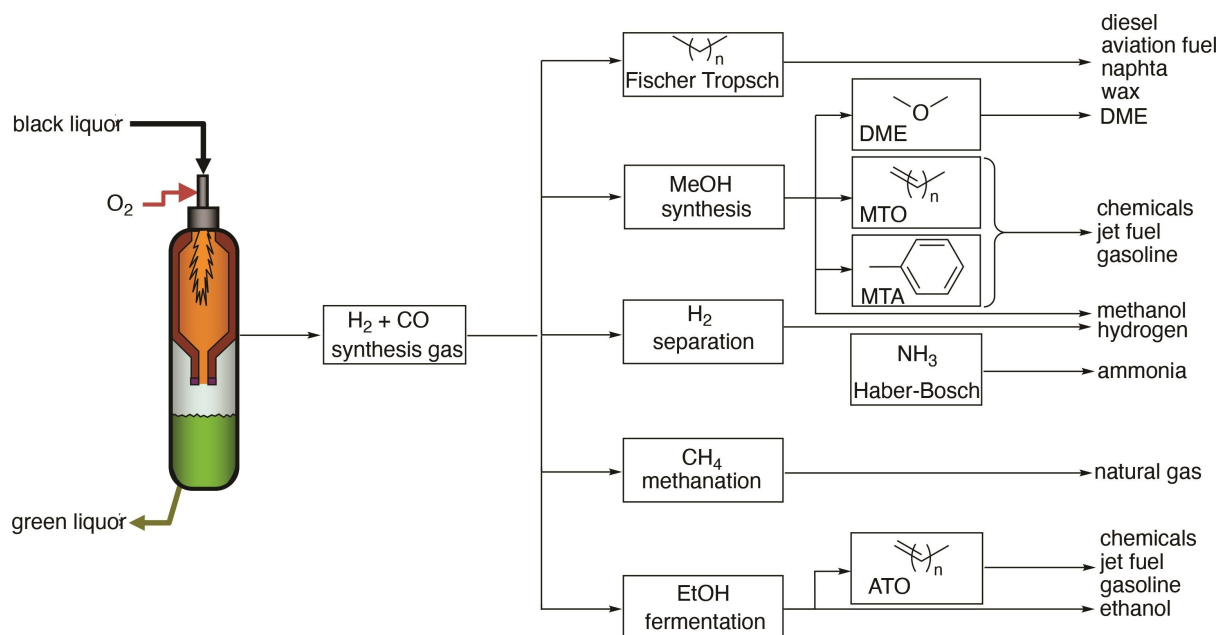

Figure 10. Illustration of important synthesis gas upgrading pathways and products. Synthesis gas can be used to produce hydrocarbons through Fischer-Tropsch chemistry or alcohol to olefin pathways. Syngas is valuable also in the production of hydrogen or methane.

recover the inorganic pulping chemicals, in a manner rather similar to the recovery boiler.

The advantages of gasifying black liquor compared to separated kraft lignin are twofold: Primarily, the liquid form allows for easy feeding to a pressurized gasifier and spray-atomization while the alkali salts present, act catalytically and increase the reactivity in the gasification process, lowering the yields of solid char and gaseous contaminants.^[104] Pilot experiments have shown that within 5–10 s of residency time the conversion of carbon to gaseous components is in excess of 99%.^[100] The catalytic effect of the alkali salts remains even if the alkali concentration is reduced by 50%. This has led to the suggestion that black liquor can be mixed with feedstocks of lower alkali content with equal reactivity performance.^[105] This was confirmed via laboratory and pilot-scale experiments with pyrolysis oil.^[106–108] Further confirmation of the catalytic effect of alkali salts is obtained from experiments with potassium-impregnated wood, which showed the aforementioned catalytic activity with concomitant reduction in char and efficient gas-phase tar decomposition, overall reducing the presence of contaminants in the synthesis gas.^[109]

From a practical point of view, the implementation of black liquor gasification requires extensive integration of a new process into an existing pulp mill.^[11,110,111] Computer simulations^[112] and pilot-scale studies^[100,103] have shown that black liquor gasification can provide complete recovery of the inorganic pulping chemicals with high sulphur reduction efficiency. During black liquor gasification, however, a fraction of the sulphur content in the black liquor ends up in the synthesis gas as hydrogen sulfide rather than as sodium sulfide in the green liquor, as is the case in the recovery boiler. A creative approach to the so called “sulphur split” issue has been proposed involving the use of the hydrogen sulfide, produced

during black liquor gasification, to perform high-yield polysulfide pulping.^[11,111] The gas phase sulphur, however, may be a complication for standard kraft pulping operations, since the hydrogen sulfide must be reabsorbed in the green liquor, with resulting increased causticizing lime consumption.

Black liquor gasification, aiming at biofuel production has been pointed out as a possible efficient method to valorize the energy surplus often present in modern pulp mills since the Syngas from black liquor gasification can be upgraded to a variety of fuels and chemicals.^[11] Amongst them, the most important are likely to be (in the near to medium term) methane, methanol, hydrogen and hydrocarbons (see Figure 10). Methane can be used as a natural gas substitute, while methanol is a promising marine fuel and a valuable feedstock for the chemical industry. Hydrocarbons, which can also be produced from Syngas via the Fischer Tropsch process, can be upgraded to fuels for a variety of transport modes, including aviation, which is a rapidly growing biofuel market. It should be noted that gasification cannot satisfy the demand of all chemicals displayed in Figure 10, however, for instance a large portion of global aviation fuel demand could be supplied.

In a manner similar to recovery boilers, the black liquor gasification energy efficiency is improved when the water content is decreased. Typically, 70–75% of the black liquor energy (heating value) is recovered as chemical energy in the Syngas for a commercial entrained flow black liquor gasification process, with the rest being recovered as heat.^[112,113] The overall energy efficiency of a black liquor gasification based biofuels plant integrated with a pulp mill can be heavily dependent on the selected biofuel product and the Syngas upgrading process configuration. Obviously, its efficiency will be improved by recovering excess energy from the gasification and the synthesis gas upgrading processes, which can be used in the pulp

mill.^[110,111,114] A challenge with gasification is the need to store large volumes of liquor in case of maintenance or shut down. The magnitude of the challenge emerges from the fact that within a single day, 1400 m³ of weak black liquor are generated.

6.1.3. Co-processing of lignin in refineries

One novel approach for converting lignin into useful products is to co-process them with fossil feedstocks in a refinery operation. An examination of a refinery set-up, shows that there are a few instances where renewable feedstocks can be considered (Figure 11). These are the hydrotreaters, the catalytic cracker and the slurry hydrocracker. The non-volatile nature of kraft lignin precludes it from being considered for the light-end hydrotreaters, e.g. the naphtha and middle distillates since they typically operate in a gaseous phase. Instead, kraft lignin can be considered for unit operations which process heavier traditional

hydrocarbon fractions. In particular, hydrotreating in trickle flow reactors has seen considerable interest.

The direct hydrotreatment of kraft lignin is not possible because the extracted kraft lignin is a solid while hydrotreating reactors are of a fixed bed type that only handles liquids such as gas oils of various fractions derived from crude oil. To address this issue, the lignin needs to be dissolved in a fossil feedstock, termed carrier liquid (typically an atmospheric or vacuum gas oil). In this section, two approaches will be described, using thermal or chemical routes.

6.1.3.1. Hydrothermal liquefaction of lignin

Hydrothermal liquefaction (HTL) refers to sub and/or supercritical conversion of biomass, typically in aqueous media (Figure 12). However, other solvents or co-solvents such as methanol, ethanol and phenol can be used.^[115,116] The HTL process can be considered similar to the geothermal process

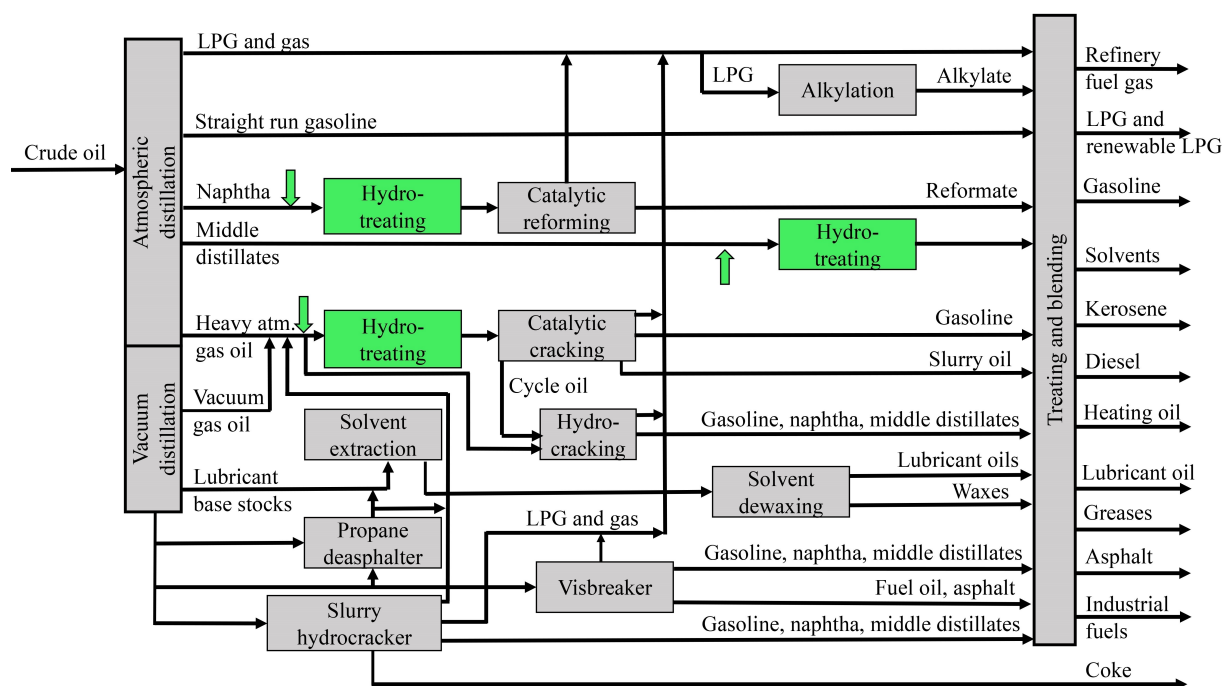

Figure 11. The potential positions where kraft lignin, a renewable feedstock, can be co-processed in a refinery. Hydrotreatment in naphtha, middle distillates or heavy gas oil streams or in slurry hydrocracker.

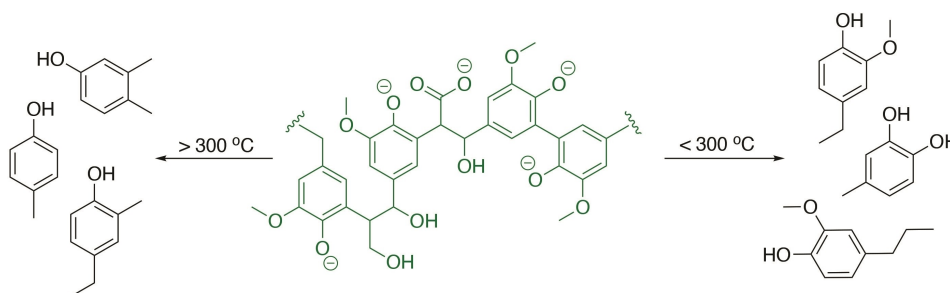

Figure 12. HTL of kraft lignin to give bio-oils comprising monophenolic compounds: left, process run at above 300 °C; and right, process run below 300 °C.

that created fossil oil from biological matter during the millennia, albeit over a much shorter time-scale. The conditions used in the HTL process are considerable more severe than what is typically employed during hydrothermal carbonization and less severe than the conditions used in hydrothermal gasification.^[117] The HTL process typically takes place at temperatures that ranges from 250 °C to 450 °C and pressures ranging from 10 to 35 MPa. Kraft lignin can be used in the process, either in the form of unseparated lignin present in black liquor or after separation; one obvious advantage of the method is that the used lignin, or biomass, does not need to be predried (Table 2).

The HTL process produces oils that are easily handled, but chemically distinct to their fossil counterparts, for example with respect to oxygen content. The carbon yield, i.e. how much of the input biomass carbon that end up in the final oil product, over the reactor can be as high as 80% when starting from black liquor,^[116] the remaining consists of gases and char.

The main differences between HTL oils and pyrolysis oils are the higher heating values and higher stabilities of HTL oils, both stemming from a lower oxygen content of the HTL oils.^[118] Indeed, the oxygen content can range from (5–20%) in the HTL case, compared to 30–50% in the case of pyrolysis oil, (percentages on mass basis).^[119] The oxygen that still remains within the HTL oils mixtures is due to low-molecular-weight compounds, such phenols.^[120,121]

The water that is present in the HTL process participates as a solvent, as a catalyst and as a reactant. During the reaction, the lignin undergoes a multitude of reactions, including hydrolysis, alkylation and repolymerisation. Furthermore, the water also plays a crucial role in the separation of the reaction products, caused by a phase separation into an oil fraction and a water fraction where the low molecular weight oxygen-containing compounds mentioned above are present.

Efforts to further improve the yields of the desired products involve the use of catalysts and co-solvents in the reaction mixture. Typical catalysts for the subcritical reaction of lignin are homogeneous alkaline materials, such as NaOH and K₂CO₃, where they primarily reduce the solid carbon formation.^[122,123]

Aside from the catalysts, the temperature, pressure, co-solvent and residence time are crucial factors in determining oil quality. The oil yields and those of anisoles and alkyl phenols typically reach a maximum with increasing temperature.^[115] Literature accounts offer the following general clear trends. Increasing the temperature, increases the heating value of the

resulting oils and the yields of phenol,^[124] catechol, cresol and other alkylphenols, increased pressures favours hydrogenolysis, and the production of phenols and cresol. Similarly, an increase in residence time lowers the resulting oil yield. Overall, there is a trade-off between temperature, pressure and residence time to maximize a certain product molecule such as phenol or catechol.

When using co-solvents, ethanol may lower the formation of solid residues while phenol addition improves the bio oil yields and lowers solid residues. The use of phenol as a co-solvent is preferred over aliphatic alcohols, likely because the latter are more reactive with the reaction intermediates. Lappalainen et al. have offered a thorough review on the effect of operating conditions for the sub- and supercritical aqueous liquefaction of kraft lignin and of black liquor lignin.^[117]

While most research efforts pertaining to the hydrothermal liquefaction of kraft lignin is performed in batch-type reactors, recent reports using continuous reactors point out to a multiple of benefits.^[125,126] This is because the residency time and the rapid heating and cooling they offer better control of the reactant residency and temperature uniformity. Consequently, re-polymerisation and other undesired lignin reactions are minimized and better controlled. Furthermore, continuous processing typically yields more monoaromatic and dimeric compounds than similar operating conditions in a batch reactor. Continuous reactors offer larger production capacities compared to batch reactors while cleaning batch reactors from carbon residues is easier.¹³⁰ A challenge with hydrothermal liquefaction is the dilution and temperature that makes the technology energy demanding. The HTL oil can subsequently be hydrogenated in an HDO-process to remove the oxygen and sulphur atoms, enhancing the oils properties. No reports using kraft lignin have been published; however HTL of sugarcane bagasse that should have similar properties, followed by hydrotreatment was recently published.^[127]

6.1.3.2. Esterification and hydroprocessing of esterified lignin

One strategy to liquify lignin is by esterification with medium to long-chain carboxylic acids. For this purpose, the predominant carboxylic acid chain length needs to be C₈ or longer.^[128] These lignin-esters are soluble to different degrees in an array of different solvents and carrier liquids. Most significantly, however, the esterified lignin is soluble in the gas oils used by the

Table 2. Representative examples of HTL of lignin.

Kraft lignin source	Concentration of lignin (wt %)	Temperature	Pressure	Oil yield	Monophenol yield	Ref.
Lignoboost Bäckhammar Sweden	5.5 %	330 °C	13 MPa	62 %	18 %	[115]
Black liquor Bäckhammar Sweden	5 %	380 °C	30 MPa	80 %	5 %	[116]
Indulin AT	10 %	374 °C	22 MPa	58–79 %	not reported	[122]
Black liquor of beech, poplar, oak and chestnut	19.4 %	280 °C	7 MPa	67 %	5 %	[123]

refinery industry and as such it may become part of the feed in hydrotreatment facilities. In this way, the lignin can be hydro-treated into fuel grade hydrocarbons (Figure 13). As anticipated the degree of substitution also influences the solubility of the lignin. For longer chain carboxylic acids the degree of substitution needs to be above approximately 50% for the C₁₈-ω9 (oleic acid).^[129–131]

There are, however, various prominent points in this technology that are of significance and crucial for success. Primarily, the metal contaminants present in the lignin need to be removed and be at low ppm levels. Even though the lignin is initially washed with a sulphuric acid solution during the initial isolation process from the black liquor, where most of the metals are removed, this is not sufficient. Additional washing to reach the strict refinery specifications regarding metal content in the hydrotreating feed is required and this is typically performed using acid washing but may include more elaborate schemes, including organic solvents.^[132–134] The purified lignin is then combined with a mixture of fatty acids and dispersed to become a homogeneous slurry. After drying from water (LignoBoost lignin contains around 35% water), the slurry is heated to approximately 140 °C before being added to the reactor. At this point, acetic anhydride and an organo-catalyst is added to the slurry. The mixture is then heated to facilitate reaction that proceeds via a variety of reactive intermediates.^[135,153] Vacuum is applied to push the equilibrium to the desired lignin carboxylic acid ester and as such acetic acid is continuously removed. The reaction is considered complete when all volatiles have been evaporated from the reaction mixture. The evaporated acetic acid and the organo-catalyst are collected and later separated so that they can be reused in the process. The lignin ester can now be diluted with a suitable carrier liquid (gas oil) and processed downstream at the hydrotreatment facility.

The most direct way of using this lignin-ester feed is to directly replace heavy fuel oils in power boilers or in maritime applications such as a green bunker fuel. The major disadvantage for the direct use of kraft lignin esters is the high sulphur content present in the initial kraft lignin. Such an application requires the use of a suitable scrubber system for the

desulphurization of flue gas,^[136] which has been in regular use for over a century.

A more refined way to utilize the lignin-esters is by first removing all the heteroatoms to create a pure hydrocarbon feed. This can be accomplished by its co-processing at a refinery in a fixed-bed hydrotreating unit. Since the lignin-ester contains a large proportion of oxygen atoms, it needs to be diluted with a suitable carrier liquid to avoid the exothermic heat that is developed from the hydrodeoxygenation. The carrier liquid can be a gas oil, or it can be the recirculated product from the hydrotreating step.^[137] By recirculation, the final biofuel will be 100% bio-derived without the use of fossil components, provided that the hydrogen used at the refinery also is derived from green sources such as biogas or through electrolysis using green electricity.

During the co-processing of a feed containing 15 wt% lignin ester of tall oil fatty acid in light gas oil, 95 wt% of the products become a liquid hydrocarbon, and the rest is water and gaseous products. A 300 h run in a continuous hydrotreatment at 120 bar and 360 °C with LHSV 0.6 h⁻¹ has been successfully operated.^[53] Many of the components derived from lignin are suitable for use as sustainable aviation fuels and lubricants as the lignin backbone is highly branched with many cyclic structures that offer the aviation fuels and lubricants their unique properties. A challenge with this approach is the limit of available fatty acids for esterification.

6.2. Material applications

Since lignin undoubtedly represents a renewable resource, in recent years, kraft lignin has been subject of intense investigations toward diverse material applications, including thermoplastics, thermosets, fillers, composites, blends etc.^[138–142]

The numerous inherent characteristics of lignin, position it as an ideal candidate for integration within new materials replacing fossil-based chemicals, polymers and derivatives. The polyphenolic character of lignin imparts in it radical scavenging and antioxidant capabilities making it attractive as a UV-stabilising moiety,^[143–154] and as an antioxidant^[140,155–164] with

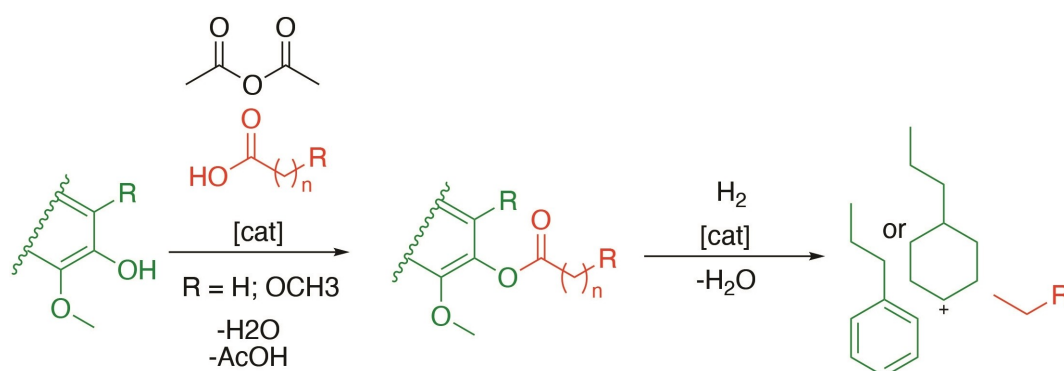

Figure 13. Esterification of kraft lignin followed by hydrotreatment to yield biofuel. Methodology has been proven in 300 h continuous refinery hydrotreatment setup.

significant potential toward applications when blended with other polymers.^[144,165]

Furthermore, considering its aromatic structure rich in both aliphatic and phenolic hydroxyl groups, lignin also shows flame retardant^[150–152,166–172] and biodegradable^[138,140,158,160,173–176] characteristics. All of the above outstanding functional features position lignin as a raw material for applications, such as coatings, bioplastics, biocomposites for 3D-printing, carbon fibers, surfactants, adhesives, hydrogels, and foams, especially when subjected to targeted chemical modification.^[177–180]

As already discussed earlier, the process of extracting the lignin from the initial lignocellulosic substrate (wood, annual plants, etc) causes a variety of modifications to it, affecting its chemical and physical properties and the heterogeneity of the material. All these characteristics in turn affect the thermo-mechanical properties of materials made from it and their process ability. Relevant functional details are thus reviewed below for the two main categories of kraft lignin applications; thermosets and thermoplastics. A challenge with many material's applications is the inherent smell of kraft lignin.

6.2.1. Kraft Lignin-based thermosets

6.2.1.1. Polyurethanes

Polyurethane (PU) resins, are a major family of materials in modern society offering fibers, foams, coatings, and elastomers. These are traditionally synthesized from petroleum-derived polyols and isocyanates. In 2018, the global polyurethane market value was estimated to be at 25 million tonnes, with an annual growth rate of 7.0% for the period 2019 to 2025.^[181] The functional groups in kraft lignin (phenolic & aliphatic hydroxyls) together with its aromatic framework, that imparts rigidity to

macromolecular structures created from it, are extremely attractive features for the synthesis of bio-based polyurethanes (PU).^[182,183]

One practical challenge with unmodified kraft lignin in PU applications is related to its moderate solubility in the reaction medium and the steric hindrance of some of the hydroxyl groups present within the lignin environment. High-temperature di-aggregation of kraft lignin in a polyether polyol in the presence of a glycerol compatibilizer, have attempted to address these issues. The improved solubility positively impacted material properties such as thermal insulation and compressive strength.^[184] The effect of replacing polyols with different lignins on the performances of rigid PU foams was recently reported (Figure 14).^[185] The authors demonstrated that hardwood organosolv lignin performed much better than hardwood kraft lignin due to its higher solubility with the polyol improving the material performances in ranges of composition up to 36% of hardwood lignin. He and co-workers^[186] studied the effect of lignin molecular weight (600–3600 Da) and weight fraction (5–40%) on the thermomechanical properties of the obtained PU elastomers. It was thus demonstrated that the T_g increases with the lignin content and that low molecular weight lignin could impart excellent Young's modulus (176.4 MPa), tensile strength (33.0 MPa) and an outstanding strain at break of 1394%. These impressive values were attributed to an efficient dispersion of low molecular weight lignin in the material, improving intermolecular interactions within the resin. An alternate approach in addressing the aforementioned reactivity limitations imposed by kraft lignin, while maintaining its reinforcing contribution, rests with its chemical modification. As anticipated, the phenolic hydroxyls in lignin are of a lower reactivity with isocyanates when compared with their aliphatic counterparts. Consequently, inserting more aliphatic functionality in kraft lignin was found to produce new lignin-based

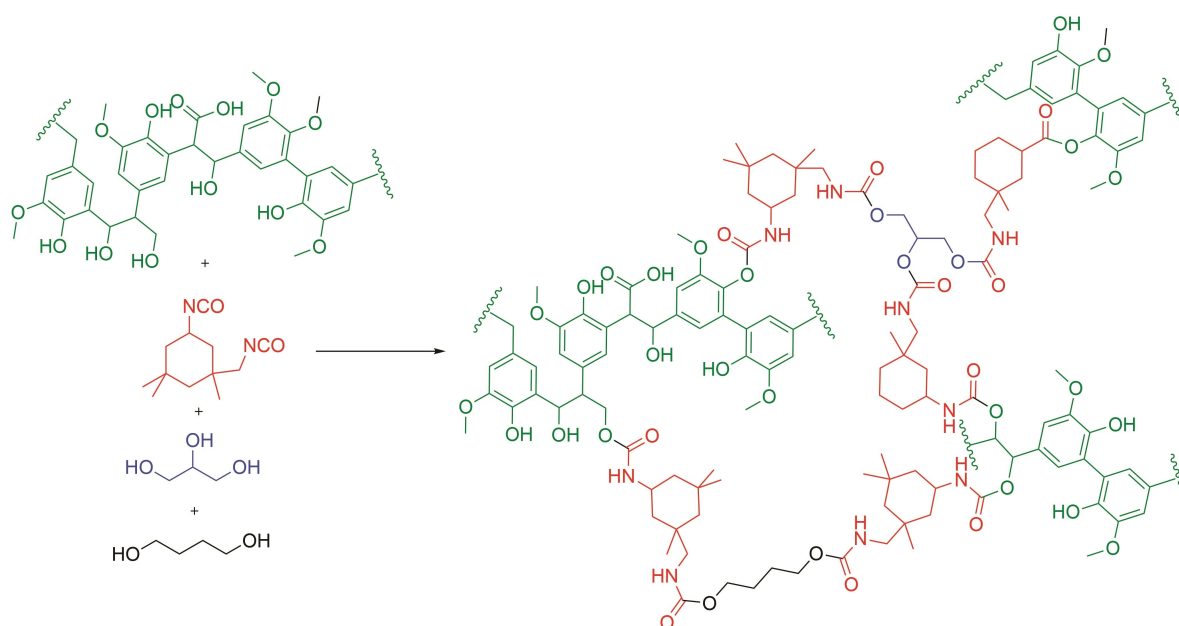

Figure 14. Molecular representation of proposed polyurethane resin using lignin, glycerol and butandiol.

polyols presenting features comparable with commercially available counterparts promoting reactivity towards isocyanates with concomitant improvements in performance.^[187,188] For example, PU foams^[189] either containing unmodified kraft lignin or pre-modified kraft lignin grafted with isocyanate groups were compared.^[190] By studying the performance of the materials it was concluded that the presence of unmodified kraft lignin hampered the reactivity of the system, requiring higher reaction times and catalyst amounts to complete the polymerization, while on the other hand, just 10% w/w of grafted lignin increased the reactivity of the system producing more flexible foams. In addition, the covalent incorporation of the modified lignin in the material resulted in improvements as demonstrated by solvent extraction studies.

6.2.1.2. Phenol-formaldehyde

Phenol-formaldehyde (PF) resins, commonly referred to as phenolic resins, represent one of the main classes of thermosetting materials used for a variety of applications due to desirable properties such as heat and chemical resistance, dimensional stability, resistance to moisture, and excellent mechanical strength. The phenolic resin market is expected to reach an estimated 15 million tonnes by 2030 based on projections with an annual growth rate of 4.4% for the period 2021 to 2030.^[191] Phenolic resins are classified as resol resins, novolac resins and other subgroups based on their chemical structure and crosslink density. During traditional phenol-formaldehyde resin synthesis, the formaldehyde reacts at positions 2-, 4-, and 6- of the phenol due to the *ortho*-/*para*-directing ability of the phenolic OH group. However, when lignin is used as the phenol, and since position 1- is occupied by the alkyl side chain of the lignin, it can only react at positions 3- and 5-, assuming that position 5 is not occupied by a methoxy group. This demonstrates the detrimental and limited (as compared to simple phenol) reactivity of lignin for such purposes. Consequently, several approaches have been devised to enhance the reactivity of

lignin so as to produce reliable phenol formaldehyde resins. Hydrolytic depolymerization by hot compressed water was demonstrated to effectively liquefy lignin yielding a mixture of substituted phenols that eventually offered a phenol-formaldehyde resin with up to 60% of the phenol being replaced by lignin. Furthermore, these resins outperformed traditional phenol-based resins in adhesive strength and demonstrated a substantial decrease in the curing activation energy.^[192]

Another approach involves demethylation chemistry on the lignin to introduce catechol moieties. This activates the C6 carbon atom of the catechol structure toward electrophilic aromatic substitution, significantly increasing the number of reactive sites for the crosslinking reaction with formaldehyde. Several pathways were historically developed with the specific aim to remove the methoxy group, such as sulphur-mediated reactions,^[193,194] reductions^[195] and oxidative processes,^[196] and halogen acids such as HBr and HI catalysed processes.^[197] The resins obtained from the partial replacement of phenol with demethylated lignin have shown better bonding strength for exterior plywood applications, faster cure kinetics, and lower formaldehyde emissions.^[197]

Phenolation represents the third main method to improve lignin reactivity (Figure 15). Ether bonds in lignin are also cleaved, thus decreasing the molecular weight of lignin. As a result, pristine phenolic functionalities are added to the lignin structure favouring the subsequent curing reaction. Phenol-formaldehyde resins containing up to 35% phenolated lignin showed a shorter gel time and a lower exothermic peak of curing. Such materials displayed thermal stabilities comparable to commercial phenol-formaldehyde resins and were successfully employed for the fabrication of plywood in full compliance with the CNS 1349 standard for Type 1 plywood that deals with their performance strengths under, dry, warm water-soaked, & repetitive boiling water soaked, conditions.

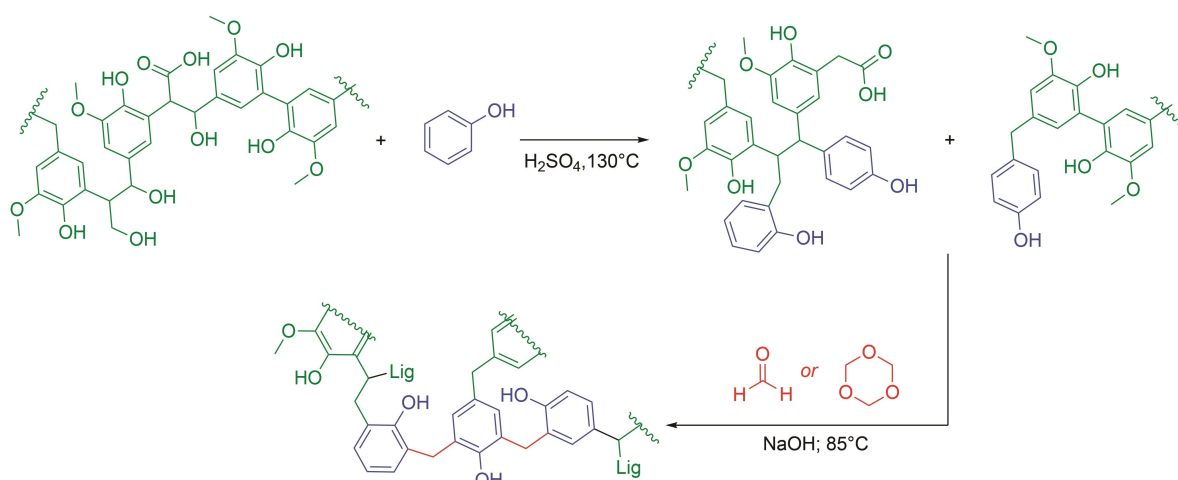

Figure 15. Phenolation of technical lignin offers additional free phenolic character to lignin, promoting its subsequent reactivity with formaldehyde to yield the desired resin.

6.2.1.3. Epoxy-resins

Epoxy resins represent another major family of thermoset materials. In 2021, the global epoxy resin market reached 3.5 million tonnes, with an estimated annual growth rate of 7.3% for the period 2022 to 2030.^[198] In this area lignin presents a viable and safe alternative for replacing toxic bisphenol -A (BPA), which is the main ingredient in epoxy thermosets,^[199] offering a variety of new possibilities in material science. Typically, epoxy functional groups are introduced by reacting lignin with epichlorohydrin under alkaline conditions. Interestingly, the selectivity of the epoxidation reaction toward lignin functional groups can be controlled by applying different catalytic systems. Basic promoters such as NaOH or KOH allow for selective epoxidation of phenols and carboxylic acids^[200] while the combination of a base and a phase transfer catalyst allows the additional epoxidation of the aliphatic hydroxyls in lignin.^[201]

Epoxidised lignins have been used to partially replace BPA to produce co-polymeric hybrid materials. For example, the effect of lignin content on the curing kinetics and the mechanical properties of thermosets, glass fiber reinforced composite materials, and metal coatings have been investigated.^[202] Hardwood depolymerized organosolv lignin (DOL) and softwood depolymerized kraft lignin (DKL) were subjected to epoxidation and were then co-polymerized with BPA-based epoxy resins at different ratios. The curing of DKL was found to require a lower reaction temperature compared to DOL due to the lower epoxy content of the DKL. Mechanical tests performed on the glass fiber reinforced composites showed that bio-based epoxy composites were of superior or comparable tensile and flexural strengths to their fully fossil-based counterparts. This applied to lignin-based epoxy resin blending ratios being less than 50–75 wt %.^[202]

From a sustainability point of view, however, BPA-free epoxy resins are significantly more attractive. In this respect, the curing kinetics of epoxy resins based on different lignins (organosolv and kraft) cured with aliphatic and aromatic diamines were examined.^[203] Aromatic amine curing agents showed a lower curing activation energy and, therefore, suitable for the curing of lignin-based epoxy resins. Their work further demonstrated that the activation energy of kraft-based epoxy resins was lower than organosolv lignin-based resins and

attributed this to the higher abundance of free phenolic hydroxyl groups present in the kraft lignin-based epoxy resins, thus more capable to promote the self-curing process. Finally, and of significance, the thermal stability of completely lignin-based cured epoxy resin materials was comparable to the thermal properties of similar fossil-based materials.

Gioia et al.^[200,204] have examined how molecular weight and connecting units in kraft lignin architecture may be used to design epoxy resin with customizable thermomechanical properties (Figure 16). The obtained materials containing up to 66% of lignin presented values of Young modulus ranging from 6 MPa for the low M_w lignins to 100 MPa establishing strong relationships between lignin structures and epoxy properties. To develop a deeper understanding, the authors further studied the effect of lignin chemical structure at the same molecular weight, using refined kraft lignin from spruce and eucalyptus, on the properties of the produced epoxy resins. It was shown that softwood spruce kraft lignin contributed to higher thermomechanical properties (1.7 GPa) compared with eucalyptus-based resins (1.4 GPa). These differences were attributed to molecular structure differences where the presence of unique guaiacyl units with several rigid C_5 -condensed aromatic units in spruce kraft, reduced the molecular mobility and increased the aromatic density. In contrast, hardwood kraft lignin is dominated by sinapyl units with lower content of condensed units but higher content of flexible methoxy units. Overall, this was the beginning of developing molecular-scale understanding in terms of the role of stiff and flexible segments on lignin molecule to material properties.

6.2.2. Lignin-based thermoplastics

Thermoplastics are commonly polymeric materials that can be melted to a flowable liquid with a repeated behaviour even after cooling of the melted material, exhibiting a robust process- thermal- and mechanical behaviour. The annual global market size of thermoplastics in 2020 was nearly 300 million tonnes which makes thermoplastics the largest commercial polymer type within the plastics market.^[205] Meanwhile, as the majority of the thermoplastics market consist of fossil -based polymers, continuing efforts are made to locate renewable

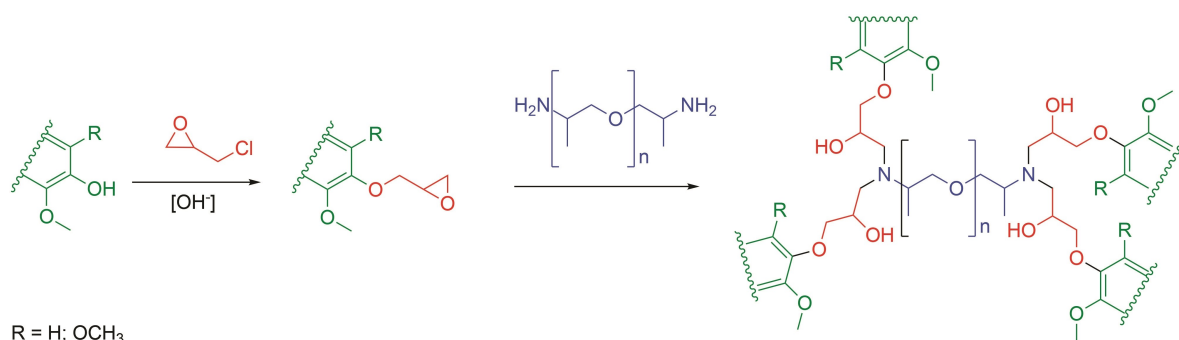

Figure 16. Synthesis of lignin-based epoxy resins, and their crosslinking with commercially available diamines to yield thermoset materials.

alternative raw materials to drive circularity and green chemistry within the segment.

As for lignin, the geographical source and treatment conditions have an impact on its thermal properties, with T_g ranging from 90–170 °C.^[152] Significant degradation of lignin can be observed at elevated temperatures greater than 200 °C. While lignin has the potential to behave as a thermoplastic its processing ability is limited due to poor melt flow behaviour and the fact that at temperatures above its T_g it undergoes irreversible radical-induced self-condensation and thus acting as a thermosetting material.^[176,206–210]

A study elegantly demonstrated that the phenolic hydroxyl groups are largely responsible for this irreversible behaviour.^[207] When softwood kraft lignin was subjected to heating, 20 °C above its T_g , as a function of time, a rapid increase in its molecular weight with the concomitant formation of irreversible cross-linking was observed. However, when the same lignin was selectively and fully methylated at its phenolic OH positions it showed thermal stability and melt re-cycling (Figure 17) appropriate for a thermoplastic material.

Some highly likely reactions offered to account for these effects are shown in Figure 18, based on abundant literature accounts of stable free radicals (R·) being present in lignin.^[154] Such stable free radicals may then readily abstract a phenolic hydrogen, present in large concentrations within kraft lignin, creating a resonance stabilized phenoxy radical which may then undergo radical coupling as shown in Figure 18.

This data provides good foundations for a rational design of single component, kraft lignin-based thermoplastic materials with reproducible polymeric properties when thermally processed in a number of manufacturing cycles. However, aside from its complex thermal behaviour, the heterogenous nature and structural molecular complexity of kraft lignin is another

challenge toward its valorisation in commercial products. While the abundant phenolic character of lignin is beneficial for some applications (radical scavenging and antioxidants) its aromatic character and, to an extent, the presence of hydrogen bonding impose miscibility challenges with many polymers.^[210–212] Consequently, several approaches have been investigated for the chemical modification of lignin to increase its lipophilicity and to enhance its compatibility with various polymers.^[213,214]

Esterification and/or etherification are common approaches for functionalizing the hydroxyl groups in lignin so as to modulate its physical properties, reduce its T_g , increase its miscibility with other polymers and enhance its processability by inducing a more robust melt flow behaviour (Figure 19).^[51,178,215–218] These two modification strategies are the most commonly applied due to the simplicity and facility of these reactions, and overall nature of the reactants.^[178,219] Esterification of the hydroxyl groups of lignin results in reduction of hydrogen bonds and increase chain mobility with implications toward melt flow characteristics. The esterification of lignin was first examined by Lewis et al., in 1943,^[128] using fatty acids. Common reagents for carrying out esterification reactions are carboxylic acids, acid anhydrides and acid chlorides,^[178] in the presence of acidic or basic catalysts such as sulphuric acid or pyridine respectively.^[138,217] In case of esterification of kraft lignin with oleic acid, lignin content in the blended product with polypropylene was 14%. Etherification of lignin can commonly be carried out via hydroxyalkylation or methylation chemistries, both being selective toward the phenolic hydroxy groups. Hydroxyalkylation of lignin in organic solvents with alkylene oxides^[220,221] has gained popularity since it can be carried out in one-step.^[138] Alternatively, methylation of lignin requires more elaborate and exotic reactants and

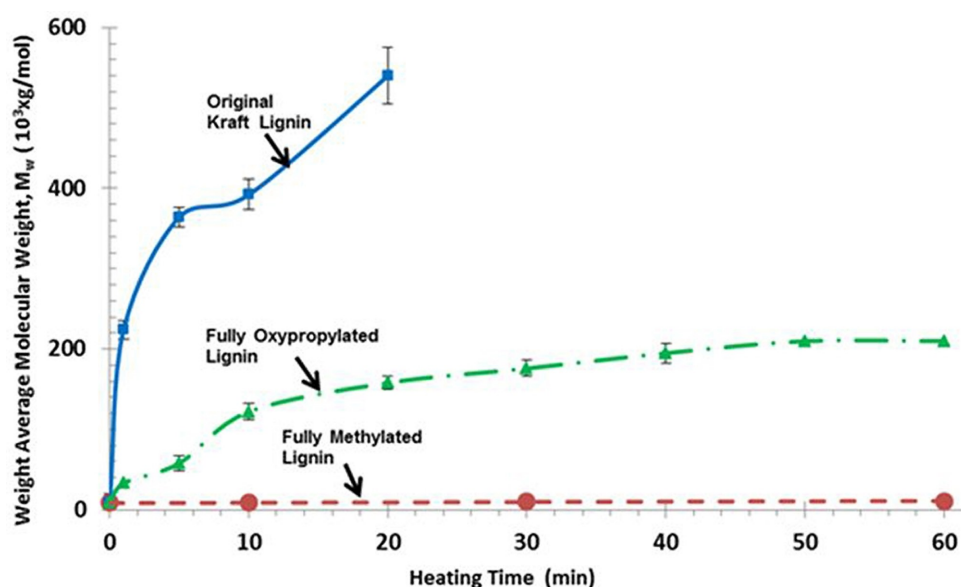

Figure 17. Effect of heating on the molecular weight of an underivatized softwood kraft lignin and the fully derivatized counterparts of the same kraft lignin. Dramatic increase in M_w is obvious in the original underivatized kraft lignin while the derivatized lignins showed a smaller M_w increase. The fully oxypropylated kraft lignin showed a small increase in the M_w as a function of heating time, while the fully methylated kraft lignin showed complete stability with respect to its molecular weight. Reprinted with permission from Ref. [207]. Copyright (2017), with permission from Bioresources.

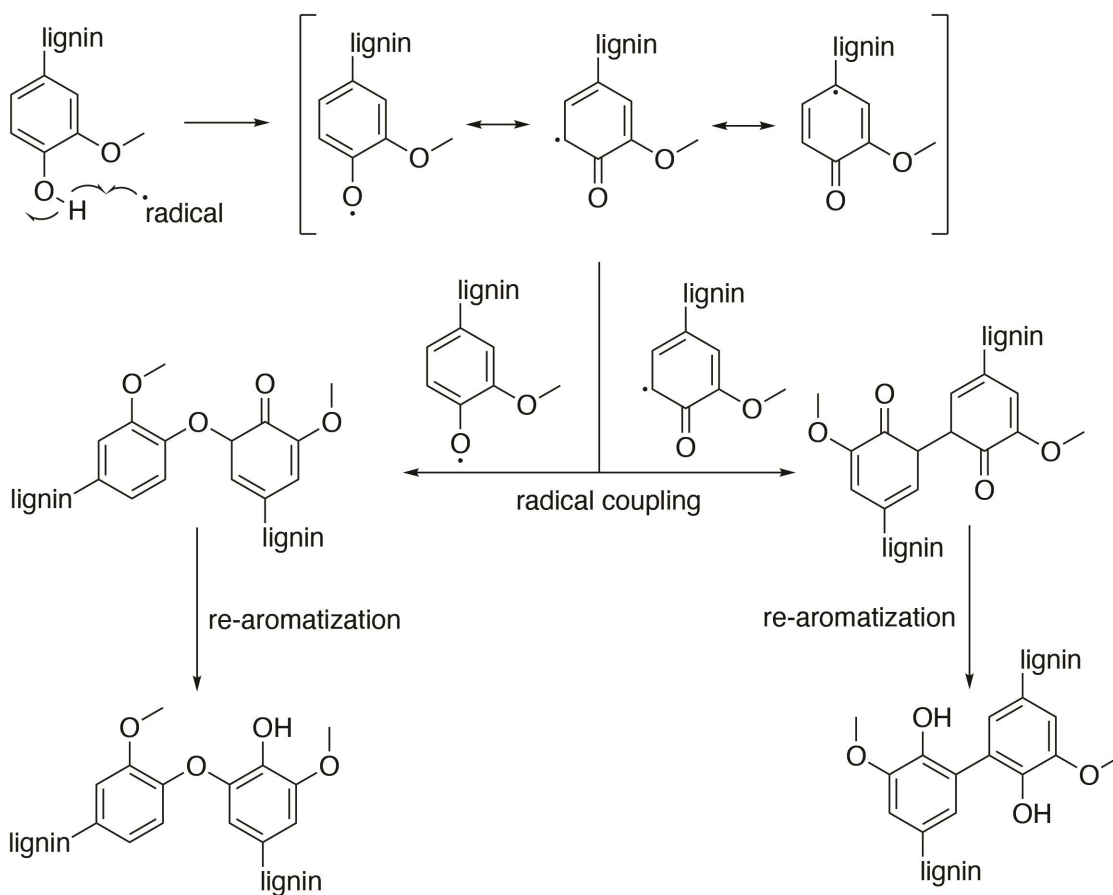

Figure 18. Showing the pathway for the creation of phenoxy radical and the ensuing radical coupling chemistry that may lead to new covalent links and thus the irreversible thermal crosslinking that is known to undergo within kraft lignin thus preventing it from being a thermoplastic material.

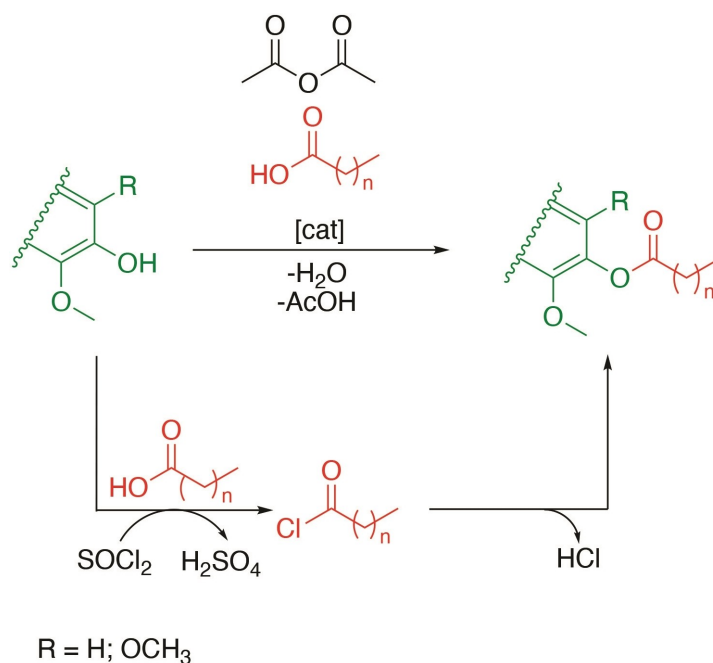

Figure 19. Esterification of kraft lignin to generate thermoplastic materials. Upper pathway uses reagents that can be recovered by distillation; lower pathway uses stoichiometric reagents.

conditions such as, dimethyl sulphate, alkyl halides or dimethyl carbonate.^[207]

Challenges with lignin-based thermoplastics is the requirement in efficient recycling, which is a prerequisite for this segment of products; low lignin content of the final blend.

6.2.3. Carbon fibers

Carbon fibers (CFs) are in prominence since they are fibers that contain mainly carbon (> 90 wt%) with outstanding mechanical properties due to their high strength-to-weight ratio. This makes them ideal as the load-bearing component in lightweight composites used in the aerospace and the automotive industries as well as for the construction of wind turbine blades, premium sporting goods etc. In 2018, the global output of carbon fibers was 108,000 tonnes and the growth rate was at double-digits (~12.5%) for the ninth consecutive year.^[222] Commercial carbon fibers are produced from fossil-based polyacrylonitrile (PAN); a costly polymer that limits the use of carbon fibers in high-end applications. There are, therefore, strong imperatives to create less expensive and environmentally sustainable carbon fibers with kraft lignin being a major candidate due to its abundance, relative low cost, and high carbon content.^[14,223,224] Alternative sources to commercially produce carbon fibers are petroleum pitch and regenerated cellulose (Rayon). Several comprehensive review articles exist in the literature specifically dealing with their processing, structure and properties^[225] and for carbon fibers produced from lignin.^[226,227]

Carbon fibers are produced via a series of technologically demanding steps with the first step being the spinning of the precursor fibers. Depending on the raw material, the precursor spinning can be performed via wet- or melt spinning with the latter being a solventless fiber production. Melt spinning, however, requires a material that thermoplastically melts before it decomposes. For this reason pitch-based precursors are melt-spun, while PAN-based precursors are wet spun.^[225] The precursor fibers are then thermally converted into carbon fibers with two additional processes; namely stabilization and carbonization. Stabilization is generally conducted in air at a temperature range between 200–400 °C while carbonization is performed at considerably higher temperatures (ca. 800–1600 °C) in a strictly inert atmosphere, protecting the carbon from oxidation and removing all non-carbon elements. Further temperature increase (up to 2400 °C), leads to graphitization.

The detailed chemistry in producing carbon fibers from polyacrylonitrile is considerably simpler than its production from lignin. Some of the main reaction pathways and products that have been identified to occur during the stabilization step of lignin are formation of ketones, formation of organic acids and formation of cross-linkages.^[228–230] Indications pointing out to the formation of graphitic structures have been published to occur during carbonization. However, the extent of possible graphitization and the role of lignin, has recently been questioned.^[231]

Understanding and beneficially modulating melt spinning has been the main research focus for producing precursors for lignin-based CFs (Figure 20). Difficulties related to melt flow issues of lignin are due to its tendency to irreversibly crosslink (as earlier discussed). These have been a salient drawback for the creation of CFs from lignin since they detrimentally slow down the continuous process of spinning and eventually stabilizing the fiber.^[226,227]

Additional, complex and challenging issues, also related to the processing ability of lignin, arise from its botanical origin and isolation procedure. Differences in the lignin structure of hardwoods and softwoods have been shown to affect the spinning properties and the cross-linking ability of the material.^[232] In general, melt-spun, single component, lignin fibers have not yet reached mechanical properties and processing times that can compete with commercial CFs.^[233] There have been, however, numerous accounts aimed at improving the processing of lignin for CF production including various pre-treatments and purification,^[234] chemical modification (e.g., phenolysis, hydrogenolysis and acetylation),^[235] chain extension,^[236,237] addition of plasticizers,^[238] blending with other polymers, such as polypropylene (PP),^[239] polyethylene oxide (PEO) polyethylene terephthalate (PET),^[240] polyvinyl alcohol (PVA),^[241] as well as reinforcing the fibers with clay or carbon nanotubes.^[242–245]

Combining lignin with PAN or other polymers is a more recent research direction aimed at capitalizing on its facile spinning, stabilization and regular graphitization and effectively using lignin as the second component. Obviously, the major drawback of such efforts is the fact that the ensuing CFs are not as inexpensive and environmentally sustainable as the use of single component lignin based CF's would have been. A fact that many times is a salient feature in a number of relevant publications.

During the period 2016–2021, an EU-funded project, ("Libre 2020") was executed aimed at producing lignin-based CFs for

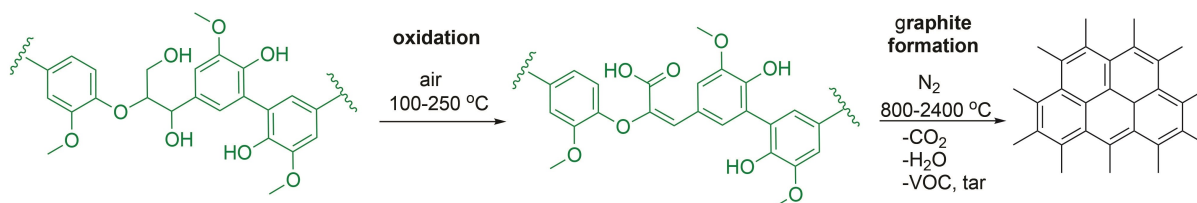

Figure 20. Graphite formation from kraft lignin, adapted from.^[266] Lignin-based carbon fibers can be used in different applications, lately energy storage applications have emerged.

the use in composites. Once again, the most promising CFs were not single component lignin-based CFs but a blend of lignin (hardwood organosolv) and polyurethane. These blends offered CFs that reached 605 MPa in tensile strength and ca. 60 GPa in tensile modulus.^[246,247]

In addition to melt-spinning, to produce lignin-based CFs, interesting accounts using solution spinning processes have also appeared in the literature. One such approach was suggested by Liu, Yuan and coworkers,^[233] where fractionated and enzymatically oxidized kraft lignin was used. Different fractions of lignin of various molecular weights, functional groups and linkages, and the insoluble fraction when mixed with 50% by weight with PAN and after solution (DMF) electrospinning, produced CFs. The oxidation applied was claimed to offer improved miscibility with PAN that eventually facilitated the spinning process and improved the elastic modulus of these 50:50 lignin-PAN fibers to levels closer to commercial CFs. Similar studies on wet spinning of blends of lignin and PAN were conducted with 23–40 wt% lignin using DMF as solvent,^[248] or with up to 50 wt% lignin using DMSO as solvent.^[249] The resulting fibers reached a tensile strength and modulus of 1.2 ± 0.1 and 130 ± 3 GPa, respectively.

Kraft lignin blended with (fiber-forming) cellulose is an approach to produce completely biobased CFs. By dissolution in a common ionic liquid-based solvent, it is possible to dry-jet wet spin fibers into an aqueous coagulation bath where the fibers solidifies. Results based on ionic liquid solvents (e.g., 1,5-diaza-bicyclo[4.3.0]non-5-enium acetate [DBNH][OAc] and 1-ethyl-3-methylimidazolium acetate [EMIM][OAc]) have, e.g., been published by research groups in Finland,^[250–254] Germany,^[255] and Sweden^[256–261], where precursor fibers with up to 70 wt% lignin content become flexible and strong. The corresponding CFs show promising mechanical properties after conversion via industrially relevant stabilization and carbonization times. Additional relevant data using *N*-methylmorpholine-*N*-oxide (NMMO) (i.e., Lyocell), solutions of up to 50:50 lignin/cellulose also offered promising fibers with the realization that higher lignin ratios, reduced spinning ability and increased the leaching of lignin during the process.^[255] The advantages of combining lignin and cellulose for CFs were further acknowledged in 2020, when the company Stora Enso announced their ongoing collaboration with the viscose fiber producer Cordenka, presenting a CF based on lignin-cellulose with a low carbon footprint under the name “NeoFibre”.

The high carbon content and the 3D polymeric nature of lignin has shown to be advantageous for replacement of fossil-derived activated carbon, in energy applications.^[262] Lignin has been used as precursor for development of various types of nanocarbon materials (for example nanoparticles, nanodots, carbon fibers and carbon nanosheets) and used to produce supercapacitors for energy storage.^[263] Results by Titirici and coworkers using electrospun lignin solution, which was subsequently carbonized and activated with CO₂ to produce free-standing microporous carbon fiber mats, showed promising results as an aqueous supercapacitor with a high specific gravimetric capacitance of 155 F g^{-1} at 0.1 A g^{-1} , excellent rate capability with 113 F g^{-1} at 250 A g^{-1} and good capacitance

retention of 94% after 6000 cycles when tested in 6 M KOH electrolyte.^[264] Another report by the same group using kraft lignin gave supercapacitor with capacitance of 192 F g^{-1} in the presence of NaNO₃.^[265]

Overall, there is promise that multicomponent lignin-containing CFs may become a commercial reality in the near future. A challenge to overcome is the mechanical properties, (ultimately connected to the quality and the degree of graphitization attained within the fiber) especially as compared to carbon fibers made from PAN. The strength and stiffness of lignin-based carbon fibers are 0.5–0.7 and 50–60 GPa as compared to PAN-based where the same figures are >2 (can reach 6) and >100 (can reach above 300) GPa. In energy storage applications, the mechanical properties are less important.

6.2.4 Colloidal dispersions

Kraft lignin valorization processes need to be economically favourable in order to become a commercial reality. Unfortunately, the processing steps associated with lignin fractionation and/or chemical functionalization invariably have a negative economic impact to the viability of kraft lignin exploitation. The possibility to use kraft lignin colloidal dispersions for various value added applications, when coupled with their inherent innocuous nature, opens new avenues to for kraft lignin valorization.

The high surface area displayed by kraft lignin nanoparticles makes them suitable for nanocomposite formulations since they can evenly distribute within the polymer matrix. This results into increased mechanical performance, barrier properties and thermal stability. They can be used for the formulation of coatings and resins with high antioxidant and UV screening activity. If loaded with active ingredients they can be used for the design and development of self healing materials, stimuli responsive controlled delivery systems in agricultural products (biocides and/or plant growth factors), cosmetics, nanomedicine and many related fields.^[267]

Lignin aggregation processes are driven by non-bonding orbitals interaction between the aromatic rings π - π stacking.^[268–270] Statistical-mechanical calculations based on the Kovalenko – Hirata closure approximation have revealed molecular-level insights that imply that lignin – lignin thermodynamic interactions are hydrophobic in nature and entropy driven. As anticipated, these π - π stacking interactions heavily depend on the chemical composition of the lignin material.^[271] When kraft lignin is dissolved in alkaline solutions it assumes a random coil conformation driven by interactions of its negatively charged groups (phenolates and carboxylates) and further hydrogen bonding with the surrounding solvent. However, as the pH decreases, association processes start operating via non-bonding orbital interactions (π - π stacking) with the formation of aggregates and fractals.^[272] These have been confirmed by small angle neutron scattering (SANS) and dynamic light scattering studies for lignin solutions and kraft lignin nanoparticles.^[273] Overall, kraft lignin dissolution/association is a process in which

there is a fine balance between electrostatic interactions, hydrogen bonds and hydrophobic interactions. When kraft lignin is dissolved in an organic solvent such as ethylene glycol, tetrahydrofuran or DMSO, it resulted in mainly an elongated ellipsoidal conformation with aggregation contributions. The dimensions of the ellipsoidal subunits have been found to be comparable to the average length of lignin chains of about ten phenyl-propane units. Dilution of the solution with a non-solvent such as water causes clumping.^[273]

The synthesis of kraft lignin nanoparticles is generally carried out starting from solutions in suitable solvents by means of bottom up methods of nanoprecipitation by addition of an antisolvent system, or by self-assembly by means of the use of shear forces generated by ultrasound (Figure 21).^[274–276] Kraft lignin nanoparticles were thus synthesized with size control by HNO₃ acidification of ethylene glycol solutions.^[277,278] Solutions of kraft lignin in tetrahydrofuran can be nano-precipitated by the addition of water by dialysis.^[279] The surface charge of the particles can also be reversed by coating the particles with cationic polyelectrolytes.^[280]

The physico-chemical characteristics of the obtained nanoparticles vary significantly according to the type of lignin and the specific experimental conditions such as the concentration of the lignin solution, the mixing time, the nature of the solvent and the pH.^[278] When the mixing time is shorter than the kinetics of the nanosphere forming and growth phases (the Danhkoler number (D_{ap}) is < 1), supersaturation of the system is rapidly reached, resulting in the formation of small and homogeneous nanoparticles. When $D_{ap} > 1$, the time of mixing of the solvent with the antisolvent is slower than the spherogenesis, which results in larger particle formation.^[281]

The formation of nanoparticles from THF and EtOH/water follows the nucleation and growth (NG) mechanism, resulting in spherical particles (Figure 21).^[282,283] On the contrary when DMSO is used as the lignin solvent, aggregation follows via a mechanism that resembles spinodal decomposition (SD). This offers the possibility to modulate the physico-chemical characteristics of the ensuing material, such as glass transition temperature (T_g), specific surface area (SSA), elastic modulus (EM) and optical properties.^[282,283] An alternative approach consists in the synthesis of kraft lignin nanoparticles starting from a hydrotropic solution usually consisting of sodium *p*-toluenesulphonate at a concentration lower than its critical micelle concentration (CMC). Further dilution of this state allows the formation of nanoparticles. In this case the yields are significantly higher since all the lignin passes into solution and not only the soluble fraction in the chosen solvent.^[282,284] A top down approach in the synthesis is constituted by the use of shear forces by mechanical action on kraft lignin^[276] or by ultrasonication of alkaline pulping liquors after precipitation by acidification.^[285]

Hybrid kraft lignin nanoparticles have been synthesized for different uses ranging from the release of actives in agricultural applications to dye absorption and even biomedical applications. In many cases inversion of superficial charge has been accomplished in order to improve antimicrobial activity by coating the particles with positively charged polyelectrolytes.^[274] Antimicrobial nanoparticle based on a silver-infused lignin core^[286] in which the core is infused with of Ag⁺ ions for bactericidal action are also surface-functionalized to increase their affinity towards targeted (bio)substrates have also been synthesized. Such nanoparticles will rapidly lose their post-

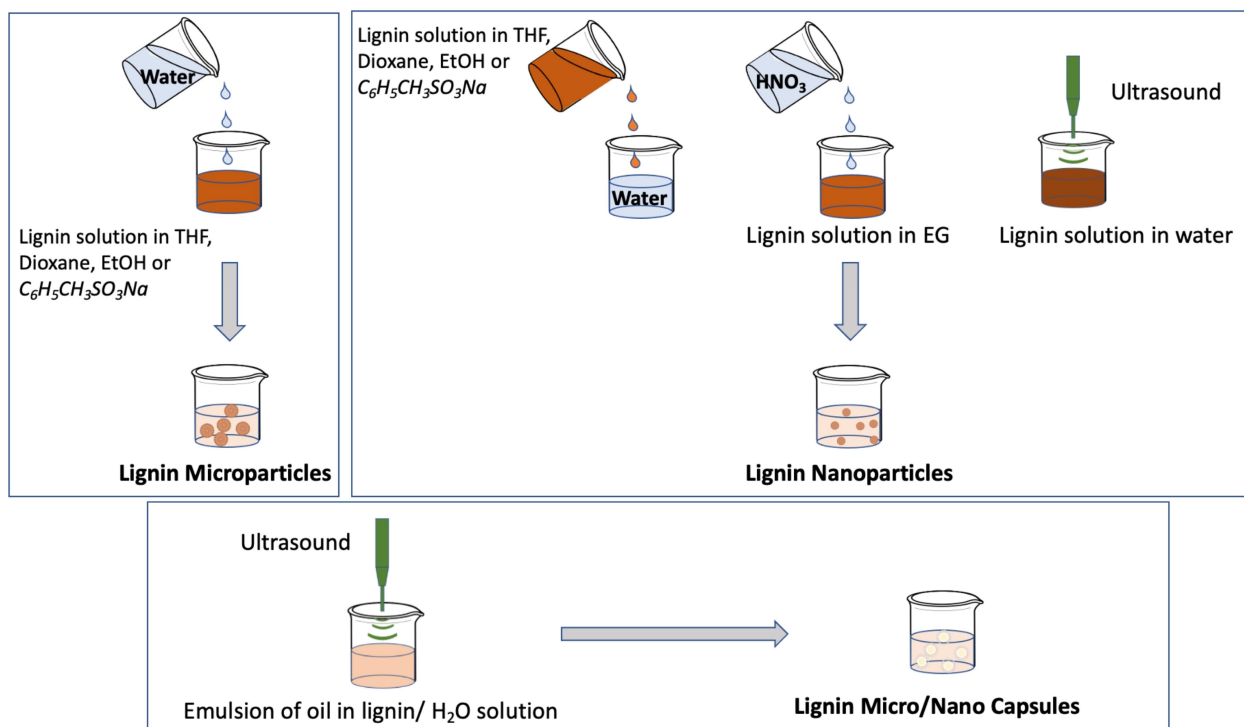

Figure 21. Technologies to generate lignin micro and nanoparticles and capsules.

utilization activity and biodegrade in the environment after disposal coated with the cationic polyelectrolyte PDAC. Magnetic hybrid kraft lignin nanoparticles have been synthesized as dye absorbant systems for waste water remediation.^[287] Microfluidics have also been used for the synthesis of hybrid kraft lignin alginate nanospheres for atrazine controlled release in agriculture.^[288] Furthermore, functionalized and crosslinked nanoparticles were prepared from hydroxymethylated lignin by hydrothermal curing.^[289]

Ultrasonication of oil in water emulsions is a powerful, efficient and robust procedure for the preparation of lignin nanocapsules containing a hydrophobic liquid core (Figure 21).^[267,290,291] Such microparticles display interesting stimuli responsive properties: the active core release can be triggered by a variety of factors such as salinity, presence of chaotropic or cosmotropic ions, pH and even pressure.^[292] Hydrophobic actives can be efficiently entrapped and released according to kinetics that depend on the shell thickness and relevant characteristics. Various characteristics of kraft lignin nanoparticles can be tuned by sonication in the presence of cross-linking agents.^[290] Alternatively, it is also possible to synthesize hybrid lignin-metal ion capsules where metal ions further link the capsule shell by metal coordination.^[291] Due to the fact that such particles scatter light efficiently they are white. This overcomes one of the major issues in using kraft lignin which is the dark color of the starting material.

Overall kraft lignin colloidal systems represent to date a lively and fast growing area in the field of kraft lignin valorization. The main challenge being the development of facile and scalable synthetic processes.

6.2.5. Biomedical uses

Although the use of kraft lignin in biomedical formulations is still in its infancy, it is raising an increasing interest due to its interesting properties. In primis, kraft lignin shows antioxidant activity, comparable to that of commercial antioxidants, fundamentally due to the presence of easily oxidized phenolic and catecholic moieties.^[164,293] Its high content in conjugated structures, also determines interesting UV absorption properties. Furthermore, kraft lignin has been reported to possess antimicrobial and antifungal activities for example against pathogenic and food borne microorganisms and *Aspergillus niger*.^[293]

All these biological properties, when coupled with its high biocompatibility,^[294] make kraft lignin an ideal candidate for a number of possible formulations that include the development of cosmetic and topical formulations, hydrogels^[295] and 3D printed materials for wound healing and tissue engineering,^[296,297] nanoparticles for improved UV barrier and as controlled drug and gene delivery systems,^[298] excipient to improve the bioavailability of drugs and films for biomedical applications. These properties have also been examined for the suppression of reactive oxygen species (ROS) in kraft lignin-gelatin hydrogels or in electrospun nanostructures for wound repair. The UV screen capacity of kraft lignins has been

exploited toward the development of cosmetic sunscreen preparations, aiming toward the partial or complete replacement of present commercial chemical and/or physical sunscreens that otherwise display a significant toxicity profile.^[299]

Furthermore, lignin nanoparticles have been applied for the controlled release of silver nanoparticles, chemotherapeutics and for gene transfection.^[300] Hybrid kraft lignin/silica silver NPs were found with significant activity towards various Gram-positive bacteria was,^[301] while Kraft lignin/hydroxyapatite composites have been studied in bone tissue engineering.^[302] To date, however, some challenges must be addressed in order to develop commercial applications. Among them, the need for a thorough evaluation of kraft lignin biocompatibility and toxicity also involving animal models is a primary prerequisite.^[303] Furthermore, the approval from the regulatory bodies such as the European Medicines Agency (EMA) and the US Food and Drug Administration (FDA) for use in the biomedical and pharmaceutical sectors are still missing. This is an especially relevant issue since the structure of kraft lignin is highly variable and heterogeneous.^[303] From this perspective the control and the chemistry of kraft lignin are particularly critical. The development of purification and extraction methods that can ensure constant molecular weight and functionality distribution, in order to arrive at a standardized kraft lignin is thus of pivotal relevance to encourage research in the field.^[303]

The major advantages and disadvantages of the different applications are given in Table 3. It should be noted that these are best guesses as many of the technologies are in their infancy with respect to technology readiness level (TRL). Thus, the listed advantages and disadvantages can change in the future.

7. TEA of value chains

The techno-economics of lignin-based products depend on several factors, including the technology pathway, the selected product and the technical characteristics of the pulp mill from which the lignin is extracted. For the purposes of this review, examples of precipitation-based, gasification-based lignin and hydrothermal liquefaction-based valorisations are presented. It should be emphasized that the production costs discussed are scale dependent. The case studies that are discussed below have been selected to represent commercially and technically viable examples. Furthermore, no energy compensations to the mill due to lignin removal are assumed. In this tentative techno-economic assessment, a production facility for 50000 tonne lignin per year is modelled, which is on the lower end of lignin extraction for a mill, however relevant in respect to only recovering excess energy. Investment costs for a facility are more advantageous for a larger facility, however, then energy compensation becomes relevant.

For each marginal tonne of pulp produced 800 kg of lignin is coproduced. To precipitate this lignin from black liquor, 160 kg of carbon dioxide is required. If sulphur is not recovered, 160 kg of sulphuric acid and 110 kg of sodium hydroxide make-

Table 3. Technical advantages and disadvantages with different applications.		
Technology	Advantages	Dissadvantages
Lime kiln fuel	Easy to operate	Low value Off gases need purification
Gasification	No co-additives required Platform chemical Different options Market size	Storage challenges if shut-down Energy consumption
HTL	No co-additives required Generates phenols Market size	Storage challenges if shut-down Low concentration of feed Energy consumption
Esterification and co-processing in refinery	Low investment cost Compatible with current infrastructure Generates fuels Market size	Requires fatty acids
Thermosets	Highly desired materials	Requires > 50 wt% other components Mechanical properties are reduced Market size
Thermoplasts	Highly desired materials	Requires > 50 wt% other components Mechanical properties are poor Recyclability is challenging
Carbon fibers	Higher yields than carbohydrate based Good properties for energy storage	Poor mechanical properties Difficult to process pure lignin feeds Market size
Colloidal dispersions	No additives required	Low TRL level Scalability
Biomedical uses	High value Natural component Inherent properties	Low TRL level Heterogenous nature

up are also needed. Other inputs comprise small inputs of energy to run the precipitation and possibly the sulphur recovery. Therefore, the operational cost ranges depend on several factors. Taking all this into account and world market prices of chemicals that are not affected by pandemics or war, the operational cost for precipitating lignin is 40–16 USD per tonne lignin, depending on sulphur recovery or not.^[10]

The total investment cost of a 50 ktonnes per year lignin separation plant is ~50 MUSD. Using an annuity factor of 0.1 (corresponding to 10 years straight depreciation or 20 years life-time with 8% return on investment) the CapEx is 80 USD per tonne pulp produced (100 USD t_{lignin}⁻¹). This makes the total lignin recovery cost, with operation and capital costs included, in the range 120–240 USD t⁻¹ pulp. However, with a marginal tonnage profit of 300 USD t pulp, there is a possible profit of 60–18 USD per marginal tonne pulp produced using the LignoBoost technology. The heating value for recovered lignin

from 1 marginal tonne pulp alone is 56 USD per tonne, and as stated, *vide supra*, precipitated lignin has successfully been used in the lime kiln to replace natural gas. Another application that could be considered is direct substitution of parts of phenol in phenol-formaldehyde resins. The market value of phenol is around 1000 USD per tonne, which would give an additional 800 USD per tonne pulp produced (Table 4). However, additional OpEx costs are not known.

In the gasification case, no precipitation is required and black liquor is used, *vide supra*. Based on the techno-economic analysis by Jafri et al.,^[10] production costs for the hydrocarbon products gasoline can be summarized as follows. For each tonne of black liquor dry solids of lignin in the black liquor, the yield of the resulting fuel is 115–125 kg after gasification followed by Fischer-Tropsch chemistry. This corresponds to 198–212 kg product per ADt of additional pulp production enabled.

Table 4. TEA of different technologies. ^[a]						
Technology	CapEx (10 year)	OpEx	Marginal tonnage value	Market value lignin product	TRL	Revenue per tonne pulp
LB + Lime kiln	80	120–240	300	56	Commercial	36–156
LB + Resin	80	120–240	300	800	9	780–900
Gasification + FT	106	148	300	188	9	234
HTL + HT	141	196	300	416	5	379

[a] All calculations are based on marginal tonnage pulp. OpEx discards energy cost in LignoBoost technology. Cost estimations were based on Ref. [10].

Investment cost is estimated to 68 MUSD for a 15.1 kt per year plant (based on the smallest BLG case, "SKKP 2a" in Ref. [10]), corresponding to 71 kADT per year of additional pulp production or 57 kt per year lignin. Using a 10 year depreciation would give a resulting CapEx of 106 USD per tonne pulp (500 USD per tonne biofuel). Operational costs comprise electricity, biomass and oxygen to a cost of 148 USD per tonne pulp (or 700 USD per kg of final product) Taking into account the marginal tonnage of increased pulp production of up to 300 USD per tonne, the resulting negative production cost for petrol fuel is 46 USD per tonne pulp. A market value of renewable transportation fuel is around 1500 USD per tonne in Europe, and would thus give an estimated additional profit of up to 188 USD per marginal tonne pulp (Table 4).

There have been multiple technoeconomic studies dealing with the HTL of lignin.^[10,304] These indicate that there are significant differences in investment costs depending on the process and the severity, i.e. the temperature and pressure used in the conversion unit operation. One study outlines the use of subcritical HTL for the extraction of an upgraded lignin product for future hydrotreating.^[10] The process for producing fully deoxygenated biofuel, starting from 50,000 tonne of lignin per year. HTL and further hydrotreatment yields around 377 kg of fuel per tonne of lignin. Per marginal tonne of pulp, 302 kg of liquid hydrocarbons are generated

The predicted investment cost of such plant is around 90 MUSD. The CapEx, depreciation and interest with an annuity of 0.1, would equal 141 USD per marginal tonne pulp (or 467 per tonne of biofuel product). Operational costs comprise heat, power and hydrogen to a cost of 196 USD per ton pulp (or 650 USD per tonne of biofuel product). Taking into account the profit of marginal tonnage of 300 USD per tonne, the resulting overall cost is 37 USD per marginal tonne pulp. However, given a market value of the advanced biofuel (1500 USD per ton), the profit per tonne pulp would be 416 USD and this is due to a higher yield of hydrocarbons than gasification case (Table 4).

The TEA of the studied examples show a considerable economic potential for kraft lignin recovery. The economical benefit stems from both the value of the kraft lignin but also from the increased pulp production, the marginal tonnage. The latter makes even low value applications such as lime kiln fuel profitable. Largest margins are found in material applications. An advantage with fuel applications is that the demand is nearly unlimited. For materials applications, this can be a challenge, where the demand can fluctuate more. For a pulp mill to implement a lignin recovery technology, a balanced supply and demand is crucial.

8. LCA of Value Chains from Kraft Lignin

Life cycle assessment is a standardized methodology (ISO 14040 14044) to study and evaluate environmental sustainability of a process or product. Biorefineries, including kraft mills with lignin outtake, have received considerable attention the last decade. Both because of an increased environmental awareness as well as the challenge regarding allocation: that is, how to

divide environmental burdens to products and co-products in multifunctional systems.^[305,306] When lignin is removed from the recovery boiler, it becomes a by-product and thus a multifunctional system is created. This is the essence of a biorefinery. Culbertson and coworkers assessed the environmental impact of a pulp mill with and without recovering kraft lignin and used both mass and economic allocation.^[307] In this study, the functional unit used was one ton of bleached pulp. They found that best environmental performance was achieved when kraft lignin was used to substitute phenol in materials applications and lower environmental benefits were found when used as a fuel for heat and power production. Manzardo and coworkers recently published a consequential LCA study using the marginal tonnage of unbleached pulp as functional unit.^[308] In this study, a novel sulfur recirculation cycle was introduced and studied: it was shown to decrease the environmental impact of the lignin recovery, where the traditional sulfur cycle had been identified as an environmental hotspot in earlier studies.^[309,310] In this consequential LCA study, it was shown that the application of the kraft lignin was crucial for the environmental performance where substitution of chemicals for materials such as carbon black, phenol and bisphenol A gave significantly better environmental performance than bitumen. In addition, the effect of burning the kraft lignin was not beneficial for environmental sustainability unless dirty fossil resources such as coal were substituted. Other studies have used the kraft lignin as functional unit, and the pulp as co-product.^[310,311] We recommend using the pulp as functional unit as this is the main product from the pulp mill.

The LCA of the studied examples disclose the complexity of dividing burdens among co-products in a multifunctional system such as a pulp mill with lignin outtake. Several studies show highest environmental sustainability benefits when lignin substitutes fossil-based materials.

9. Summary and Outlook

The ongoing transformation towards a more sustainable society is leading to an increased demand for bio-based products. Lately, the land use issue -using virgin land for production of biomass- has been debated. To use side-streams from forestry and agriculture is a more sustainable option. Kraft lignin can to a large extent be recovered instead of burnt in the recovery boiler. This is a commercially attractive possibility for the pulp and paper industry since: 1) the pulp mill can increase its production of pulp; 2) there are opportunities to provide additional value-added products. These opportunities are further compounded when one considers the limited amount of sustainable biomass resources. Kraft lignin valorization offers such opportunities as outlined in this Review.

It has been demonstrated that separation of kraft lignin from black liquor can increase pulp production without major investments in recovery boiler capacity. Consequently, today there is an emerging market for this raw material with current global production potential estimated to be about 28 million tonnes, which, with further pulp mill technical improvements,

may further increase in a second iteration and optimization of the mill. Several technologies to extract lignin from black liquor have been developed, with the LignoBoost process having been commercialized and implemented in three mills. Kraft lignin is a technical lignin whose molecular structure has recently been considerably elucidated^[26] using several different techniques: a combination of solvent-mediated extractions and by ³¹P NMR, ¹³C NMR, QQ-HSQC and GPC (Gel Permeation Chromatography) analyses. These analyses have provided elucidation of two different fractions, a smaller phenol-rich fraction and a larger fraction that resembles native lignin.

Despite these advances, uncertainties related to the structure and abundance of various inter-unit linkages in kraft lignin set limits for the proper elucidation of material structure-property relations. For example, the presence of quaternary carbons and their elucidation via direct ring to ring NMR coupling could offer significant advances since these evade quantification by ¹³C NMR due to massive signal overlap in the aromatic region.

Understanding the chemistry occurring from black liquor to green liquor was advocated by one of the reviewers. In addition, to steer the kraft process not only for the pulp but also for the lignin, would be of interest in order to obtain a more stable and predictive production of defined kraft lignin.

Kraft lignin can be used as a feedstock for both fuels and materials. However, challenges still remain due to variables such as nature of the lignocellulosic feedstock, pulp mill operations, precipitation technologies and the overall heterogeneity of the emerging kraft lignin. For some applications such as its use as lime kiln fuel, gasification or conversion to hydrocarbons by HTL or esterification, issues of heterogeneity bear no consequence. For material applications, however, the heterogeneity of lignin can be of pivotal significance. Promising efforts to mitigate this variable via fractionation approaches that are based on separation on the basis of molecular size, selective solvation and fractional precipitation have emerged. Technoeconomic and environmental sustainability assessments of such fractionation technologies still remain.

A challenge with the material applications is the requirement of additional reagents. Current investigations on thermo-setting material report lignin contents in the material in the range 10–66%. Future work efforts should target maximizing the lignin content of materials to improve on the sustainability factor. Nevertheless, material applications have shown most benefits from environmental sustainability perspectives, even taking blending into account. The mechanical properties of lignin-based materials are usually poor. In the future, we anticipate strategies to overcome this or finding suitable applications. One such application is energy carriers in for example batteries, an area that is emerging at the moment.

Another challenge, especially for thermoplastics, is recyclability. This may also become an issue with thermoset materials and energy carriers in the future. Recycling and end of life of lignin-based materials from kraft lignin is an unexplored area that will become important in the future. However, before this, stable value chains including recycling are needed in order to get reliable data.

Technical economic assessment of value chains from black liquor to different products using either precipitation, gasification or hydrothermal liquefaction show significant incentives for the pulp mill to recover lignin. The marginal tonnage alone is a strong incentive; the possible revenue from the lignin stream is an additional benefit. We foresee that both TEA and LCA will become important tools to evaluate novel value chains in the future.

As pointed out by one of the reviewers, it would be beneficial for the development of kraft lignin valorization to establish standard procedures for characterization of feedstocks^[312] and reporting yields from transformations.^[313] In addition, a database over kraft lignin would be beneficial for mapping variations in the feedstock in order to relate both pulping conditions to raw material; reactivity of raw material in different applications. In a future, this could potentially aid pulp mill design in producing a kraft lignin suitable for specific applications in addition to the pulp.

Finally, as one of the reviewers stated in the assessments of this review: we emphasize the importance of continued research to unlock the full potential of kraft lignin as a sustainable resource. We encourage further exploration and innovation in the utilization of kraft lignin so as its potential as a valuable resource be actualized.

Acknowledgements

In an alphabetical order, D. A. and C. C. thank the Marie Skłodowska-Curie foundation for funding via the B-Ligzymes Grant Agreement no: 824017, C. C. thanks Next Generation EU – Progetto ECS00000043 – Programma Ecosistema dell’innovazione “Interconnected Nord-Est Innovation Ecosystem (iNEST)”, CUP H43 C22000540006; This study was carried out within the Interconnected Nord-Est Innovation Ecosystem (iNEST) and received funding from the European Union Next-GenerationEU (PIANO NAZIONALE DI RIPRESA E RESILIENZA (PNRR) – MISSIONE 4 COMPONENTE 2, INVESTIMENTO 1.5 – D.D. 1058 23/06/2022, ECS00000043). This manuscript reflects only the authors’ views and opinions, neither the European Union nor the European Commission can be considered responsible for them. C. H. thanks the Swedish Foundation for Strategic Environmental Research (Mistra: project Mistra STEPS, project number 2014/44); K. J. thanks the Swedish Research Council Formas (grant 2022-01943). ML is thankful to the Knut and Alice Wallenberg (KAW) Foundation grant no. KAW 2018.0452 for funding; C. P. and J. S. M. S. thank the Swedish Foundation for Strategic Environmental Research (Mistra: project Mistra Safe-Chem, project number 2018/11); E. S. thanks Marie Skłodowska-Curie foundation for funding.

Conflict of Interests

JSMS is professor at Stockholm university and co-founder of RenFuel and RenFuel Materials. ML is a professor at KTH and co-founder of Proligreen AB.

Data Availability Statement

Data sharing is not applicable to this article as no new data were created or analyzed in this study.

Keywords: kraft lignin · lignin recovery · pulping · biofuels biomaterials

- [1] M. Ek, G. Gellerstedt, G. Henriksson, in *Volume 2 Pulping Chemistry and Technology*, De Gruyter, 2009.
- [2] Y. Zeng, S. Zhao, S. Yang, S.-Y. Ding, *Curr. Opin. Biotechnol.* **2014**, *27*, 38–45.
- [3] D. Mboowa, *Biomass Convers. Biorefinery* **2021**, DOI 10.1007/s13399-020-01243-6.
- [4] M. Ragnar, G. Henriksson, M. E. Lindström, M. Wimby, J. Blechschmidt, S. Heinemann, in *Ullmanns Encycl. Ind. Chem.*, John Wiley & Sons, Ltd, **2014**, pp. 1–92.
- [5] "Forest product statistics," can be found under <http://www.fao.org/forestry/statistics/en/>, n.d.
- [6] Y. Wang, M. E. Lindstrom, G. Henriksson, *BioResources* **2011**, *6*, 2425–2434.
- [7] K. Nieminen, M. Paananen, H. Sixta, *Ind. Eng. Chem. Res.* **2014**, *53*, 11292–11302.
- [8] E. K. Vakkilainen, P. Ahtila, *O PAPEL* **2011**, *72*, 8.
- [9] J. Jönsson, K. Pettersson, T. Berntsson, S. Harvey, *Int. J. Energy Res.* **2013**, *37*, 1017–1035.
- [10] Y. Jafri, E. Wetterlund, S. Mesfun, H. Rådberg, J. Mossberg, C. Hulteborg, E. Furusjö, *Appl. Energy* **2020**, *279*, 115879.
- [11] M. Naqvi, J. Yan, E. Dahlquist, *Bioresour. Technol.* **2010**, *101*, 8001–8015.
- [12] R. Rinaldi, R. Jastrzebski, M. T. Clough, J. Ralph, M. Kennema, P. C. A. Bruijninx, B. M. Weckhuysen, *Angew. Chem. Int. Ed.* **2016**, *55*, 8164–8215.
- [13] M. V. Galkin, J. S. M. Samec, *ChemSusChem* **2016**, *9*, 1544–1558.
- [14] I. F. Demuner, J. L. Colodette, A. J. Demuner, C. M. Jardim, *BioResources* **2019**, *14*, 7543–7581.
- [15] M. Lawoko, J. S. M. Samec, *Curr. Opin. Green Sustain. Chem.* **2023**, *40*, 100738.
- [16] J. Zakzeski, P. C. A. Bruijninx, A. L. Jongerius, B. M. Weckhuysen, *Chem. Rev.* **2010**, *110*, 3552–3599.
- [17] Z. Sun, B. Fridrich, A. de Santi, S. Elangovan, K. Barta, *Chem. Rev.* **2018**, *118*, 614–678.
- [18] A. Adler, I. Kumaniaev, A. Karacic, K. R. Baddigam, R. J. Hanes, E. Subbotina, A. W. Bartling, A. J. Huertas-Alonso, A. Moreno, H. Håkansson, A. P. Mathew, G. T. Beckham, J. S. M. Samec, *Joule* **2022**, *6*, 1845–1858.
- [19] W. Boerjan, J. Ralph, M. Baucher, *Annu. Rev. Plant Biol.* **2003**, *54*, 519–546.
- [20] N. Giummarella, Y. Pu, A. J. Ragauskas, M. Lawoko, *Green Chem.* **2019**, *21*, 1573–1595.
- [21] O. Fearon, S. Kuitunen, K. Ruuttunen, V. Alopaeus, T. Vuorinen, *Ind. Eng. Chem. Res.* **2020**, *59*, 12977–12985.
- [22] J. Gierer, L.-Å. Smedman, G. Cederberg, R. B. Jensen, C. T. Pederson, E. Larsen, *Acta Chem. Scand.* **1965**, *19*, 1103–1112.
- [23] R. Kondo, Y. Tsutsumi, H. Imamura, *Holzforchung* **1987**, *41*, 83–88.
- [24] G. E. Miksche, A. Kjekshus, A. D. Mukherjee, D. G. Nicholson, J. T. Southern, *Acta Chem. Scand.* **1972**, *26*, 3275–3281.
- [25] S. Ljunggren, *Sven. Papperstidn.* **1980**, *83*: 13.
- [26] J. Gierer, *Wood Sci. Technol.* **1980**, *14*, 241–266.
- [27] Ö. Eriksson, D. A. I. Goring, B. O. Lindgren, *Wood Sci. Technol.* **1980**, *14*, 267–279.
- [28] A. N. Hall, S. Hollingshead, H. N. Rydon, *J. Chem. Soc. Resumed* **1961**, *0*, 4290–4295.
- [29] C. Crestini, H. Lange, M. Sette, D. S. Argyropoulos, *Green Chem.* **2017**, *19*, 4104–4121.
- [30] G. Gellerstedt, E.-L. Lindfors, *Nord. Pulp Pap. Res. J.* **1987**, *2*, 71–75.
- [31] M. Sette, R. Wechselberger, C. Crestini, *Chem. Eur. J.* **2011**, *17*, 9529–9535.
- [32] D. Ibarra, M. I. Chávez, J. Rencoret, J. C. Del Río, A. Gutiérrez, J. Romero, S. Camarero, M. J. Martínez, J. Jiménez-Barbero, A. T. Martínez, *J. Agric. Food Chem.* **2007**, *55*, 3477–3490.
- [33] H. Sixta, H.-U. Süß, A. Potthast, M. Schwanninger, A. W. Krottscheck, in *Handb. Pulp*, John Wiley & Sons, Ltd, **2006**, pp. 609–708.
- [34] C. S. Lancefield, H. L. J. Wienk, R. Boelens, B. M. Weckhuysen, P. C. A. Bruijninx, *Chem. Sci.* **2018**, *9*, 6348–6360.
- [35] G. Gellerstedt, A. Majtnerova, L. Zhang, *C. R. Biol.* **2004**, *327*, 817–826.
- [36] A. Majtnerová, G. Gellerstedt, *Nord. Pulp Pap. Res. J.* **2006**, *21*, 129–134.
- [37] G. Gellerstedt, *Ind. Crops Prod.* **2015**, *77*, 845–854.
- [38] S. C. Fox, A. G. McDonald, *BioResources* **2010**, *5*, 990–1009.
- [39] N. Giummarella, P. A. Lindén, D. Areskog, M. Lawoko, *ACS Sustainable Chem. Eng.* **2020**, *8*, 1112–1120.
- [40] N. Giummarella, I. V. Pylypchuk, O. Sevastyanova, M. Lawoko, *ACS Sustainable Chem. Eng.* **2020**, *8*, 10983–10994.
- [41] A. S. Hay, B. M. Boulette, *J. Org. Chem.* **1976**, *41*, 1710–1712.
- [42] M. Helander, H. Theliander, M. Lawoko, G. Henriksson, L. Zhang, M. E. Lindström, *BioResources* **2013**, *8*, 2270–2282.
- [43] J. Marton, T. Marton, *Tappi J.* **1964**, *47*, 471–476.
- [44] A. Jacobs, O. Dahlman, *Nord. Pulp Pap. Res. J.* **2000**, *15*, 120–127.
- [45] A. Ház, M. Jablonský, I. Šurina, F. Kačík, T. Bubeníková, J. Ďurkovič, *Forests* **2019**, *10*, 483.
- [46] L. Dehne, C. Vila Babarro, B. Saake, K. U. Schwarz, *Ind. Crops Prod.* **2016**, *86*, 320–328.
- [47] Y. Zhao, A. Tagami, G. Dobe, M. E. Lindström, O. Sevastyanova, *Polymer* **2019**, *11*, 538.
- [48] J. Asikkala, T. Tamminen, D. S. Argyropoulos, *J. Agric. Food Chem.* **2012**, *60*, 8968–8973.
- [49] W. G. Glasser, V. Davé, C. E. Frazier, *J. Wood Chem. Technol.* **1993**, *13*, 545–559.
- [50] S. Kubo, J. F. Kadla, *J. Polym. Environ.* **2005**, *13*, 97–105.
- [51] O. Gordobil, E. Robles, I. Egués, J. Labidi, *RSC Adv.* **2016**, *6*, 86909–86917.
- [52] O. Musl, S. Galler, G. Wurzer, M. Bacher, I. Sulaeva, I. Sumerskii, A. K. Mahler, T. Rosenau, A. Potthast, *Biomacromolecules* **2022**, *23*, 1413–1422.
- [53] D. Di Francesco, C. Dahlstrand, J. Löfstedt, A. Orebom, J. Verendel, C. Carrick, Å. Håkansson, S. Eriksson, H. Rådberg, H. Wallmo, M. Wimby, F. Huber, C. Federsel, M. Backmark, J. S. M. Samec, *ChemSusChem* **2021**, *14*, 2414–2425.
- [54] L. Dessbesell, M. Paleologou, M. Leitch, R. Pulkki, C. (Charles) Xu, *Renewable Sustainable Energy Rev.* **2020**, *123*, 109768.
- [55] W. Zhu, G. Westman, H. Theliander, *J. Wood Chem. Technol.* **2014**, *34*, 77–97.
- [56] L. Kouisni, A. Gagné, K. Maki, P. Holt-Hindle, M. Paleologou, *ACS Sustainable Chem. Eng.* **2016**, *4*, 5152–5159.
- [57] M. A. Lake, J. C. Blackburn, *Cellulose Chem. Technol.* **2014**, *48*, 799–804.
- [58] P. Tomani, P. Axegård, N. Berglin, A. Lovell, D. Nordgren, *Cellul. Chem. Technol.* **2011**, *45*, 533.
- [59] M. Gigli, C. Crestini, *Green Chem.* **2020**, *22*, 4722–4746.
- [60] M. Alekhina, O. Ershova, A. Ebert, S. Heikkinen, H. Sixta, *Ind. Crops Prod.* **2015**, *66*, 220–228.
- [61] S. Gouveia, C. Fernández-Costas, M. A. Sanromán, D. Moldes, *Bioresour. Technol.* **2012**, *121*, 131–138.
- [62] G. Wang, H. Chen, *Sep. Purif. Technol.* **2013**, *105*, 98–105.
- [63] T. V. Lourençon, F. A. Hansel, T. A. da Silva, L. P. Ramos, G. I. B. de Muniz, W. L. E. Magalhães, *Sep. Purif. Technol.* **2015**, *154*, 82–88.
- [64] J. Velez, M. C. Thies, *Bioresour. Technol.* **2013**, *148*, 586–590.
- [65] M. Ragnar, O. T. Lindgren, N.-O. Nilvebrant, *J. Wood Chem. Technol.* **2000**, *20*, 277–305.
- [66] C. Cui, R. Sun, D. S. Argyropoulos, *ACS Sustainable Chem. Eng.* **2014**, *2*, 959–968.
- [67] Y.-Y. Wang, M. Li, C. E. Wyman, C. M. Cai, A. J. Ragauskas, *ACS Sustainable Chem. Eng.* **2018**, *6*, 6064–6072.
- [68] H. Lange, P. Schiffels, M. Sette, O. Sevastyanova, C. Crestini, *ACS Sustainable Chem. Eng.* **2016**, *4*, 5136–5151.
- [69] X. Jiang, D. Savithri, X. Du, S. Pawar, H. Jameel, H. Chang, X. Zhou, *ACS Sustainable Chem. Eng.* **2017**, *5*, 835–842.
- [70] A.-S. Jääskeläinen, T. Liitiä, A. Mikkelsen, T. Tamminen, *Ind. Crops Prod.* **2017**, *103*, 51–58.
- [71] X. Meng, A. Parikh, B. Seemala, R. Kumar, Y. Pu, C. E. Wyman, C. M. Cai, A. J. Ragauskas, *Bioresour. Technol.* **2019**, *272*, 202–208.
- [72] G. Wang, X. Liu, B. Yang, C. Si, A. M. Parvez, J. Jang, Y. Ni, *ACS Sustainable Chem. Eng.* **2019**, *7*, 10112–10120.
- [73] A.-S. Jääskeläinen, P. W. Keyriläinen, T. Liitiä, T. Tamminen, *Nord. Pulp Pap. Res. J.* **2017**, *32*, 485–492.
- [74] A. Duval, F. Vilaplana, C. Crestini, M. Lawoko, *Holzforchung* **2016**, *70*, 11–20.
- [75] C. M. Hansen, in *Hansen Solubility Parameters: A User's Handbook, Second Edition*, CRC Press, Boca Raton, **2007**.

- [76] T. Saito, J. H. Perkins, F. Vautard, H. M. Meyer, J. M. Messman, B. Tolnai, A. K. Naskar, *ChemSusChem* **2014**, *7*, 221–228.
- [77] V. Passoni, C. Scarica, M. Levi, S. Turri, G. Griffini, *ACS Sustainable Chem. Eng.* **2016**, *4*, 2232–2242.
- [78] T.-Q. Yuan, J. He, F. Xu, R.-C. Sun, *Polym. Degrad. Stab.* **2009**, *94*, 1142–1150.
- [79] A. P. Dodd, J. F. Kadla, S. K. Straus, *ACS Sustainable Chem. Eng.* **2015**, *3*, 103–110.
- [80] R. J. A. Gosselink, J. E. G. van Dam, E. de Jong, E. L. Scott, J. P. M. Sanders, J. Li, G. Gellerstedt, *Holzforchung* **2010**, *64*, 193–200.
- [81] J. A. Hemmingson, *J. Wood Chem. Technol.* **1987**, *7*, 527–553.
- [82] R. Mörck, A. Reimann, K. P. Kringstad, *Holzforchung* **1988**, *42*, 111–116.
- [83] P. Mousavioun, W. O. S. Doherty, *Ind. Crops Prod.* **2010**, *31*, 52–58.
- [84] Y. Nakasaka, T. Yoshikawa, Y. Kawamata, T. Tago, S. Sato, T. Takanohashi, Y. Koyama, T. Masuda, *ChemCatChem* **2017**, *9*, 2875–2880.
- [85] K. Wang, F. Xu, R. Sun, *Int. J. Mol. Sci.* **2010**, *11*, 2988–3001.
- [86] R. E. Majdar, C. Crestini, H. Lange, *ChemSusChem* **2020**, *13*, 4735–4742.
- [87] A. Toledano, L. Serrano, A. Garcia, I. Mondragon, J. Labidi, *Chem. Eng. J.* **2010**, *157*, 93–99.
- [88] M. Norgren, B. Lindström, *Holzforchung* **2000**, *54*, 528–534.
- [89] O. Sevastyanova, M. Helander, S. Chowdhury, H. Lange, H. Wedin, L. Zhang, M. Ek, J. F. Kadla, C. Crestini, M. E. Lindström, *J. Appl. Polym. Sci.* **2014**, *131*, DOI 10.1002/app.40799.
- [90] A. Keyoum, R. Sjö Dahl, G. Henriksson, M. Ek, G. Gellerstedt, M. E. Lindström, *Ind. Crops Prod.* **2004**, *20*, 143–150.
- [91] P. K. Bhattacharya, R. K. Todi, M. Tiwari, C. Bhattacharjee, S. Bhattacharjee, S. Datta, *Desalination* **2005**, *174*, 287–297.
- [92] S. Francey, H. Tran, A. Jones, *Tappi J.* **2009**, *8*, 33–39.
- [93] S. K. Sansaniwal, K. Pal, M. A. Rosen, S. K. Tyagi, *Renewable Sustainable Energy Rev.* **2017**, *72*, 363–384.
- [94] H. Yu, Z. Wu, G. Chen, *Renewable Energy* **2018**, *121*, 559–567.
- [95] M. P. Pandey, C. S. Kim, *Chem. Eng. Technol.* **2011**, *34*, 29–41.
- [96] K. Saviharju, *Bioresour. Technol.* **1993**, *46*, 145–151.
- [97] P. McKeough, *Bioresour. Technol.* **1993**, *46*, 135–143.
- [98] H. Eriksson, S. Harvey, *Energy* **2004**, *29*, 581–612.
- [99] M. Naqvi, J. Yan, E. Dahlquist, *Appl. Energy* **2012**, *97*, 49–55.
- [100] Y. Jafri, E. Furusjö, K. Kirtania, R. Gebart, *Energy Fuels* **2016**, *30*, 3175–3185.
- [101] P. Carlsson, H. Wiinikka, M. Marklund, C. Grönberg, E. Pettersson, M. Lidman, R. Gebart, *Fuel* **2010**, *89*, 4025–4034.
- [102] H. Wiinikka, P. Carlsson, M. Marklund, C. Grönberg, E. Pettersson, M. Lidman, R. Gebart, *Fuel* **2012**, *93*, 117–129.
- [103] E. Furusjö, R. Stare, I. Landäl, P. Löwnertz, *Energy Fuels* **2014**, *28*, 7517–7526.
- [104] J. Li, A. R. P. Van Heiningen, *Ind. Eng. Chem. Res.* **1990**, *29*, 1776–1785.
- [105] E. Furusjö, E. Pettersson, *Energy Fuels* **2016**, *30*, 10575–10582.
- [106] A. Bach-Oller, E. Furusjö, K. Umeki, *Biomass Bioenergy* **2015**, *79*, 155–165.
- [107] A. Bach-Oller, K. Kirtania, E. Furusjö, K. Umeki, *Fuel* **2017**, *202*, 46–55.
- [108] A. Bach-Oller, K. Kirtania, E. Furusjö, K. Umeki, *Fuel* **2017**, *197*, 240–247.
- [109] K. Umeki, G. Häggström, A. Bach-Oller, K. Kirtania, E. Furusjö, *Energy Fuels* **2017**, *31*, 5104–5110.
- [110] K. Pettersson, S. Harvey, *Energy* **2012**, *37*, 136–153.
- [111] S. Consonni, R. E. Katofsky, E. D. Larson, *Chem. Eng. Res. Des.* **2009**, *87*, 1293–1317.
- [112] E. Furusjö, Y. Jafri, *Biomass Convers. Biorefinery* **2018**, *8*, 19–31.
- [113] J. Andersson, E. Furusjö, E. Wetterlund, J. Lundgren, I. Landäl, *Energy Convers. Manage.* **2016**, *110*, 240–248.
- [114] Y. Jafri, E. Wetterlund, M. Anheden, I. Kulander, Å. Håkansson, E. Furusjö, *Energy* **2019**, *166*, 401–413.
- [115] T. D. H. Nguyen, M. Maschietti, L.-E. Åmand, L. Vamling, L. Olausson, S.-I. Andersson, H. Theliander, *Bioresour. Technol.* **2014**, *170*, 196–203.
- [116] A. Orebom, J. J. Verendel, J. S. M. Samec, *ACS Omega* **2018**, *3*, 6757–6763.
- [117] J. Lappalainen, D. Baudouin, U. Hornung, J. Schuler, K. Melin, S. Bjelić, F. Vogel, J. Konttinen, T. Joronen, *Energies* **2020**, *13*, 3309.
- [118] N. Doassans-Carrère, J.-H. Ferrasse, O. Boutin, G. Mauviel, J. Lédé, *Energy Fuels* **2014**, *28*, 5103–5111.
- [119] M. S. Haider, D. Castello, L. A. Rosendahl, *Energy Fuels* **2021**, *35*, 10611–10622.
- [120] J. M. Jarvis, K. O. Albrecht, J. M. Billing, A. J. Schmidt, R. T. Hallen, T. M. Schaub, *Energy Fuels* **2018**, *32*, 8483–8493.
- [121] M. S. Haider, D. Castello, K. M. Michalski, T. H. Pedersen, L. A. Rosendahl, *Energies* **2018**, *11*, 3360.
- [122] S. S. Toor, L. Rosendahl, A. Rudolf, *Energy* **2011**, *36*, 2328–2342.
- [123] O. Y. Abdelaziz, C. P. Hultheberg, *ChemSusChem* **2020**, *13*, 4382–4384.
- [124] H. Curmi, C. Chirat, A. Roubaud, M. Peyrot, G. Haarlemmer, D. Lachenal, *J. Supercrit. Fluids* **2022**, *181*, 105489.
- [125] I. Kristianto, S. O. Limarta, Y.-K. Park, J.-M. Ha, D. J. Suh, Y. Jeong, J. Jae, *Energy Fuels* **2019**, *33*, 6421–6428.
- [126] O. Y. Abdelaziz, K. Li, P. Tunå, C. P. Hultheberg, *Biomass Convers. Biorefinery* **2018**, *8*, 455–470.
- [127] D. G. Prakash, K. P. Gopinath, V. Vinatha, S. Shreya, R. Sivaramkrishnan, N. T. Lan Chi, *Chemosphere* **2021**, *285*, 131491.
- [128] H. F. Lewis, F. E. Brauns, M. A. Buchanan, E. B. Brookbank, *Ind. Eng. Chem.* **1943**, *35*, 1113–1117.
- [129] J. Samec, J. Löfstedt, C. Dahlstrand, A. Paptchikine, S. Sawadjoon, *Composition Comprising Esters of Lignin and Oil or Fatty Acids*, **2015**, WO2015094099 A1.
- [130] J. Samec, J. Löfstedt, C. Dahlstrand, A. Paptchikine, S. Sawadjoon, *Composition Comprising Esters of Lignin and Organic Solvent*, **2015**, WO2015094098 A1.
- [131] C. Dahlstrand, A. Orebom, J. Samec, S. Sawadjoon, J. Löfstedt, *Composition Comprising Derivatized Lignin for Fuel Production*, **2016**, WO2016204682 A1.
- [132] C. Dahlstrand, A. Orebom, *Ultrapure Kraft Lignin Composition*, **2018**, WO2018004447 A1.
- [133] C. Hultheberg, L. Stigsson, L. Kollberg, *A Method for Producing a Low Ash Content Biofuel Mixture Comprising Tall Oil Pitch and Lignin and Use of the Biofuel Mixture in a Petroleum Refinery*, **2020**, SE1950531 A1.
- [134] A. Arkell, M. Sundin, *Lignin Purification*, **2020**, WO2020013752 A1.
- [135] J. Löfstedt, C. Dahlstrand, A. Orebom, G. Meuzelaar, S. Sawadjoon, M. V. Galkin, P. Agback, M. Wimby, E. Corresa, Y. Mathieu, L. Sauvanaud, S. Eriksson, A. Corma, J. S. M. Samec, *ChemSusChem* **2016**, *9*, 1392–1396.
- [136] *J. Air Pollut. Control Assoc.* **1977**, *27*, 948–961.
- [137] C. Dahlstrand, J. Samec, *Continuous Production of Fuel Grade Hydrocarbons by Hydro-treatment of Functionalized Lignin*, **2020**, US20200109286 A1.
- [138] C. Wang, S. S. Kelley, R. A. Venditti, *ChemSusChem* **2016**, *9*, 770–783.
- [139] D. Kun, B. Pukánszky, *Eur. Polym. J.* **2017**, *93*, 618–641.
- [140] W. O. S. Doherty, P. Mousavioun, C. M. Fellows, *Ind. Crops Prod.* **2011**, *33*, 259–276.
- [141] S. Sen, S. Patil, D. S. Argyropoulos, *Green Chem.* **2015**, *17*, 4862–4887.
- [142] D. Di Francesco, D. Rigo, K. Reddy Baddigam, A. P. Mathew, N. Hedin, M. Selva, J. S. M. Samec, *ChemSusChem* **2022**, *15*, e202200326.
- [143] P. Alexy, B. Košíková, G. Podstránska, *Polymer* **2000**, *41*, 4901–4908.
- [144] A. Gregorová, Z. Cibulková, B. Košíková, P. Šimon, *Polym. Degrad. Stab.* **2005**, *89*, 553–558.
- [145] Q. Xing, D. Ruch, P. Dubois, L. Wu, W.-J. Wang, *ACS Sustainable Chem. Eng.* **2017**, *5*, 10342–10351.
- [146] Y. Qian, X. Zhong, Y. Li, X. Qiu, *Ind. Crops Prod.* **2017**, *101*, 54–60.
- [147] Y. Qian, X. Qiu, S. Zhu, *ACS Sustainable Chem. Eng.* **2016**, *4*, 4029–4035.
- [148] S. R. Yearla, K. Padmasree, *J. Exp. Nanosci.* **2016**, *11*, 289–302.
- [149] Y. Qian, X. Qiu, S. Zhu, *Green Chem.* **2014**, *17*, 320–324.
- [150] M. Parit, P. Saha, V. A. Davis, Z. Jiang, *ACS Omega* **2018**, *3*, 10679–10691.
- [151] Q. Wang, H. Du, F. Zhang, Y. Zhang, M. Wu, G. Yu, C. Liu, B. Li, H. Peng, *J. Mater. Chem. A* **2018**, *6*, 13021–13030.
- [152] N. Mandlekar, A. Cayla, F. Rault, S. Giraud, F. Salaün, G. Malucelli, J. Guan, *Ind. Eng. Chem. Res.* **2017**, *56*, 13704–13714.
- [153] D. Kai, Y. K. Chua, L. Jiang, C. Owh, S. Y. Chan, X. J. Loh, *RSC Adv.* **2016**, *6*, 86420–86427.
- [154] S. V. Patil, D. S. Argyropoulos, *ChemSusChem* **2017**, *10*, 3284–3303.
- [155] C. Pouteau, P. Dole, B. Cathala, L. Averous, N. Boquillon, *Polym. Degrad. Stab.* **2003**, *81*, 9–18.
- [156] S. Domenek, A. Louaifi, A. Guinault, S. Baumberger, *J. Polym. Environ.* **2013**, *21*, 692–701.
- [157] M. P. Vinardell, V. Ugartondo, M. Mitjans, *Ind. Crops Prod.* **2008**, *27*, 220–223.
- [158] F. Bertini, M. Canetti, A. Cacciamani, G. Elegir, M. Orlandi, L. Zoia, *Polym. Degrad. Stab.* **2012**, *97*, 1979–1987.
- [159] Y. Uraki, Y. Sugiyama, K. Koda, S. Kubo, T. Kishimoto, J. F. Kadla, *Biomacromolecules* **2012**, *13*, 867–872.
- [160] A. Pinkert, D. F. Goeke, K. N. Marsh, S. Pang, *Green Chem.* **2011**, *13*, 3124–3136.
- [161] X. Dong, M. Dong, Y. Lu, A. Turley, T. Jin, C. Wu, *Ind. Crops Prod.* **2011**, *34*, 1629–1634.

- [162] D. Kai, W. Ren, L. Tian, P. L. Chee, Y. Liu, S. Ramakrishna, X. J. Loh, *ACS Sustainable Chem. Eng.* **2016**, *4*, 5268–5276.
- [163] G. F. Bass, T. H. Epps, *Polym. Chem.* **2021**, *12*, 4130–4158.
- [164] H. Sadeghifar, D. S. Argyropoulos, *ACS Sustainable Chem. Eng.* **2015**, *3*, 349–356.
- [165] I. Blanco, G. Cicala, A. Latteri, G. Saccullo, A. M. M. El-Sabbagh, G. Ziegmann, *J. Therm. Anal. Calorim.* **2017**, *127*, 147–153.
- [166] A. De Chirico, M. Armanini, P. Chini, G. Cioccolo, F. Provasoli, G. Audisio, *Polym. Degrad. Stab.* **2003**, *79*, 139–145.
- [167] M. Canetti, F. Bertini, A. De Chirico, G. Audisio, *Polym. Degrad. Stab.* **2006**, *91*, 494–498.
- [168] L. Liu, M. Qian, P. Song, G. Huang, Y. Yu, S. Fu, *ACS Sustainable Chem. Eng.* **2016**, *4*, 2422–2431.
- [169] L. Liu, G. Huang, P. Song, Y. Yu, S. Fu, *ACS Sustainable Chem. Eng.* **2016**, *4*, 4732–4742.
- [170] Y. Yu, S. Fu, P. Song, X. Luo, Y. Jin, F. Lu, Q. Wu, J. Ye, *Polym. Degrad. Stab.* **2012**, *97*, 541–546.
- [171] J. Zhang, E. Fleury, Y. Chen, M. A. Brook, *RSC Adv.* **2015**, *5*, 103907–103914.
- [172] G. P. Mendis, S. G. Weiss, M. Korey, C. R. Boardman, M. Diertenberger, J. P. Youngblood, J. A. Howarter, *Green Mater.* **2016**, *4*, 150–159.
- [173] A. Naseem, S. Tabasum, K. M. Zia, M. Zuber, M. Ali, A. Noreen, *Int. J. Biol. Macromol.* **2016**, *93*, 296–313.
- [174] W. J. Grigsby, S. M. Scott, M. I. Plowman-Holmes, P. G. Middlewood, K. Recabar, *Acta Biomater.* **2020**, *104*, 95–103.
- [175] L. Bai, L. G. Greca, W. Xiang, J. Lehtonen, S. Huan, R. W. N. Nugroho, B. L. Tardy, O. J. Rojas, R. A. Dixon, P. Gilna, M. Keller, P. Langan, A. K. Naskar, J. N. Saddler, T. J. Tschaplinski, G. A. Tuskan, C. E. Wyman, *Science* **2014**, *344*, 1246843.
- [180] G. Zinoviyev, I. Sumerskii, P. Korntner, I. Sulaeva, T. Rosenau, A. Potthast, *J. Wood Chem. Technol.* **2017**, *37*, 171–183.
- [181] Grand View Research, *Rep. Mark.* **2019**, 1–16.
- [182] M. S. Karunaratna, R. C. Smith, *Sustainability* **2020**, *12*, 734, DOI 10.3390/su12020734.
- [183] N. Mahmood, Z. Yuan, J. Schmidt, C. Charles, *Renewable Sustainable Energy Rev.* **2016**, *60*, 317–329.
- [184] A. Nemati, D. Alwyn, C. Evans, B. Laycock, D. James, *Ind. Crops Prod.* **2018**, *117*, 149–158.
- [185] X. Pan, J. N. Saddler, *Biotechnol. Biofuels* **2013**, *6*, 1–10.
- [186] H. Li, J. Sun, C. Wang, S. Liu, D. Yuan, X. Zhou, J. Tan, L. Stubbs, C. He, *ACS Sustainable Chem. Eng.* **2017**, *5*, 7942–7949.
- [187] H. Sadeghifar, C. Cui, D. S. Argyropoulos, *Ind. Eng. Chem. Res.* **2012**, *51*, 16713–16720.
- [188] B. Ahvazi, O. Wojciechowicz, T. M. Ton-That, J. Hawari, *J. Agric. Food Chem.* **2011**, *59*, 10505–10516.
- [189] C. A. Cateto, M. F. Barreiro, A. E. Rodrigues, M. N. Belgacem, *Ind. Eng. Chem. Res.* **2009**, *48*, 2583–2589.
- [190] S. Gómez-fernández, L. Ugarte, T. Calvo-correas, C. Pe, M. A. Corcuera, A. Eceiza, *Ind. Crops Prod.* **2017**, *100*, 51–64.
- [191] “Phenolic Resin Market Share, Size and Forecasts 2030,” can be found under <http://www.alliedmarketresearch.com/phenolic-resin-market-A14853>, n.d.
- [192] L. Yan, Y. Cui, G. Gou, Q. Wang, M. Jiang, S. Zhang, D. Hui, J. Gou, Z. Zhou, *Compos. Part B* **2017**, *112*, 8–14.
- [193] J. Li, W. Wang, S. Zhang, Q. Gao, W. Zhang, J. Li, *RSC Adv.* **2016**, *6*, 67435–67443.
- [194] L. Hu, H. Pan, Y. Zhou, C. Y. Hse, C. Liu, B. Zhang, B. Xu, *J. Wood Chem. Technol.* **2014**, *34*, 122–134.
- [195] J. J. Meister, *J. Macromol. Sci. Polym. Rev.* **2002**, *42*, 235–289.
- [196] R. Bernini, M. Barontini, P. Mosesso, G. Pepe, S. M. Willför, R. E. Sjöholm, P. C. Eklund, R. Saladino, *Org. Biomol. Chem.* **2009**, *7*, 2367–2377.
- [197] H. Wang, T. L. Eberhardt, C. Wang, S. Gao, H. Pan, *Polymer* **2019**, *11*, 1–16.
- [198] “Epoxy Resin Market Size, Share & Trends Analysis Report By Application (Paints & Coatings, Construction), By Region (APAC, North America, Europe), And Segment Forecasts, 2021–2028 – Gil,” can be found under <http://www.giiresearch.com/report/grvi1036643-epoxy-resin-market-size-share-trends-analysis.html>, n.d.
- [199] J. R. Rochester, *Reprod. Toxicol.* **2013**, *42*, 132–155.
- [200] C. Gioia, G. Lo Re, M. Lawoko, L. Berglund, *J. Am. Chem. Soc.* **2018**, *140*, 4054–4061.
- [201] A. Jablonskis, A. Arshanitsa, A. Arnautov, G. Telysheva, D. Evtuguin, *Ind. Crops Prod.* **2018**, *112*, 225–235.
- [202] F. Ferdosian, Y. Zhang, Z. Yuan, M. Anderson, C. Charles, *Eur. Polym. J.* **2016**, *82*, 153–165.
- [203] F. Ferdosian, Z. Yuan, M. Anderson, C. Charles, *Thermochim. Acta* **2015**, *618*, 48–55.
- [204] C. Gioia, M. Colonna, A. Tagami, L. Medina, O. Sevastyanova, L. A. Berglund, M. Lawoko, *Biomacromolecules* **2020**, *21*, 1920–1928.
- [205] O. Olabisi, K. Adewale, in *Handbook of Thermoplastics*, CRC Press, **2016**.
- [206] H. Jeong, J. Park, S. Kim, J. Lee, N. Ahn, H. Roh, *Fibers Polym.* **2013**, *14*, 1082–1093.
- [207] C. Cui, H. Sadeghifar, S. Sen, D. S. Argyropoulos, *BioResources* **2013**, *8*, 864–886.
- [208] S. Kubo, J. F. Kadla, *Biomacromolecules* **2005**, *6*, 2815–2821.
- [209] S. Sen, S. Patil, D. S. Argyropoulos, *Green Chem.* **2015**, *17*, 1077–1087.
- [210] M. N. Collins, M. Nechifor, F. Tanasä, M. Zänoagä, A. McLoughlin, M. A. Stróżyk, M. Culebras, C.-A. Teacă, *Int. J. Biol. Macromol.* **2019**, *131*, 828–849.
- [211] M. Parit, Z. Jiang, *Int. J. Biol. Macromol.* **2020**, *165*, 3180–3197.
- [212] B. Wang, D. Sun, H.-M. Wang, T.-Q. Yuan, R.-C. Sun, *ACS Sustainable Chem. Eng.* **2019**, *7*, 2658–2666.
- [213] A. V. Maldhure, J. D. Ekhe, E. Deenadayalan, *J. Appl. Polym. Sci.* **2012**, *125*, 1701–1712.
- [214] S. Atifi, C. Miao, W. Y. Hamad, *J. Appl. Polym. Sci.* **2017**, *134*, 45103.
- [215] I. Ghosh, R. K. Jain, W. G. Glasser, *J. Appl. Polym. Sci.* **1999**, *74*, 448–457.
- [216] L. Dehne, C. Vila, B. Saake, K. U. Schwarz, *J. Appl. Polym. Sci.* **2017**, *134*, DOI 10.1002/app.44582.
- [217] A. Orebom, D. Di Francesco, P. Shakari, J. S. M. Samec, C. Pierrou, *Molecules* **2021**, *26*, 3219.
- [218] R. R. N. Sailaja, M. V. Deepthi, *Mater. Des.* **2010**, *31*, 4369–4379.
- [219] Y.-L. Chung, J. V. Olsson, R. J. Li, C. W. Frank, R. M. Waymouth, S. L. Billington, E. S. Sattely, *ACS Sustainable Chem. Eng.* **2013**, *1*, 1231–1238.
- [220] L. C.-F. Wu, W. G. Glasser, *J. Appl. Polym. Sci.* **1984**, *29*, 1111–1123.
- [221] S. S. Kelley, W. G. Glasser, T. C. Ward, *J. Wood Chem. Technol.* **1988**, *8*, 341–359.
- [222] J. Zhang, G. Lin, U. Vaidya, H. Wang, *Composites Part B* **2023**, *250*, 110463.
- [223] J. F. Kadla, S. Kubo, R. A. Venditti, R. D. Gilbert, A. L. Compere, W. Griffith, *Carbon* **2002**, *40*, 2913–2920.
- [224] H. Mainka, O. Täger, E. Körner, L. Hilfert, S. Busse, F. T. Edelmann, A. S. Herrmann, *J. Mater. Res. Technol.* **2015**, *4*, 283–296.
- [225] B. A. Newcomb, *Compos. Part Appl. Sci. Manuf.* **2016**, *91*, 262–282.
- [226] D. A. Baker, T. G. Rials, *J. Appl. Polym. Sci.* **2013**, *130*, 713–728.
- [227] F. Souto, V. Calado, N. Pereira, *Mater. Res. Express* **2018**, *5*, 072001.
- [228] H. Mainka, L. Hilfert, S. Busse, F. Edelmann, E. Haak, A. S. Herrmann, *J. Mater. Res. Technol.* **2015**, *4*, 377–391.
- [229] Q. Liu, S. Wang, Y. Zheng, Z. Luo, K. Cen, *J. Anal. Appl. Pyrolysis* **2008**, *82*, 170–177.
- [230] H. Kleinhan, L. Salmén, *J. Appl. Polym. Sci.* **2016**, *133*, 43965, DOI 10.1002/app.43965.
- [231] W. J. Sagues, A. Jain, D. Brown, S. Aggarwal, A. Suarez, M. Kollman, S. Park, D. S. Argyropoulos, *Green Chem.* **2019**, *21*, 4253–4265.
- [232] O. Hosseinaei, D. P. Harper, J. J. Bozell, T. G. Rials, *ACS Sustainable Chem. Eng.* **2016**, *4*, 5785–5798.
- [233] Q. Li, S. Xie, W. K. Serem, M. T. Naik, L. Liu, J. S. Yuan, *Green Chem.* **2017**, *19*, 1628–1634.
- [234] D. A. Baker, N. C. Gallego, F. S. Baker, *J. Appl. Polym. Sci.* **2012**, *124*, 227–234.
- [235] L. M. Steudle, E. Frank, A. Ota, U. Hageroth, S. Henzler, W. Schuler, R. Neupert, M. R. Buchmeiser, *Macromol. Mater. Eng.* **2017**, *302*, 1600441.
- [236] S. Sen, H. Sadeghifar, D. S. Argyropoulos, *Biomacromolecules* **2013**, *14*, 3399–3408.
- [237] H. Sadeghifar, S. Sen, S. V. Patil, D. S. Argyropoulos, *ACS Sustainable Chem. Eng.* **2016**, *4*, 5230–5237.
- [238] A. Ayoub, T. Treasure, L. Hansen, T. Nypelö, H. Jameel, S. Khan, H. Chang, M. A. Hubbe, R. A. Venditti, *Cellulose* **2021**, *28*, 1039–1053.

- [239] S. Kubo, T. Yoshida, J. F. Kadla, *J. Wood Chem. Technol.* **2007**, *27*, 257–271.
- [240] J. F. Kadla, S. Kubo, *Compos. Part Appl. Sci. Manuf.* **2004**, *35*, 395–400.
- [241] L. Bostan, O. Hosseinaei, R. Fourné, A. S. Herrmann, *Philos. Trans. R. Soc. Math. Phys. Eng. Sci.* **2021**, *379*, 20200334.
- [242] W. Qin, J. F. Kadla, *Ind. Eng. Chem. Res.* **2011**, *50*, 12548–12555.
- [243] X. Xu, J. Zhou, L. Jiang, G. Lubineau, S. A. Payne, D. Gutschmidt, *Carbon* **2014**, *80*, 91–102.
- [244] S. Wang, Z. Zhou, H. Xiang, W. Chen, E. Yin, T. Chang, M. Zhu, *Compos. Sci. Technol.* **2016**, *128*, 116–122.
- [245] L. Szabó, R. Milotskyi, H. Ueda, T. Tsukegi, N. Wada, K. Takahashi, *Chem. Eng. J.* **2021**, *405*, 126640.
- [246] M. Culebras, A. Beaucamp, Y. Wang, M. M. Clauss, E. Frank, M. N. Collins, *ACS Sustainable Chem. Eng.* **2018**, *6*, 8816–8825.
- [247] M. Collins, M. C. Rubio, *Improvements Relating to Carbon Fibre Precursors*, **2020**, US2020347232 A1.
- [248] A. Oroumei, M. Naeb, *Fibers Polym.* **2017**, *18*, 2079–2093.
- [249] J. Jin, A. A. Ogale, *J. Appl. Polym. Sci.* **2018**, *135*, 45903.
- [250] Y. Ma, S. Asaadi, L.-S. Johansson, P. Ahvenainen, M. Reza, M. Alekhina, L. Rautkari, A. Michud, L. Hauru, M. Hummel, H. Sixta, *ChemSusChem* **2015**, *8*, 4030–4039.
- [251] N. Byrne, R. De Silva, Y. Ma, H. Sixta, M. Hummel, *Cellulose* **2018**, *25*, 723–733.
- [252] M. Trogen, N.-D. Le, D. Sawada, C. Guizani, T. V. Lourençon, L. Pitkänen, H. Sixta, R. Shah, H. O'Neill, M. Balakshin, N. Byrne, M. Hummel, *Carbohydr. Polym.* **2021**, *252*, 117133.
- [253] N.-D. Le, M. Trogen, Y. Ma, R. J. Varley, M. Hummel, N. Byrne, *Carbohydr. Polym.* **2020**, *250*, 116918.
- [254] J. Mikkilä, M. Trogen, K. A. Y. Koivu, J. Kontro, J. Kuuskeri, R. Maltari, Z. Dekere, M. Kemell, M. R. Mäkelä, P. A. Nousiainen, M. Hummel, J. Sipilä, K. Hildén, *ACS Omega* **2020**, *5*, 6130–6140.
- [255] R. Protz, A. Lehmann, J. Bohrisch, J. Ganster, H.-P. Fink, *Carbohydr. Polym. Technol. Appl.* **2021**, *2*, 100041.
- [256] C. Olsson, E. Sjöholm, A. Reimann, *Holzforchung* **2017**, *71*, 275–283.
- [257] A. Bengtsson, J. Bengtsson, C. Olsson, M. Sedin, K. Jedvert, H. Theliander, E. Sjöholm, *Holzforchung* **2018**, *72*, 1007–1016.
- [258] J. Bengtsson, K. Jedvert, T. Köhnke, H. Theliander, *J. Appl. Polym. Sci.* **2019**, *136*, 47800.
- [259] A. Bengtsson, J. Bengtsson, M. Sedin, E. Sjöholm, *ACS Sustainable Chem. Eng.* **2019**, *7*, 8440–8448.
- [260] J. Bengtsson, K. Jedvert, T. Köhnke, H. Theliander, *J. Appl. Polym. Sci.* **2021**, *138*, 50629.
- [261] A. Bengtsson, J. Bengtsson, K. Jedvert, M. Kakkonen, O. Tanhuanpää, E. Brännvall, M. Sedin, *ACS Omega* **2022**, *7*, 16793–16802.
- [262] A. Beaucamp, M. Muddasar, I. S. Aminiun, M. M. Leite, M. Culebras, K. Latha, M. C. Gutiérrez, D. Rodriguez-Padron, F. del Monte, T. Kennedy, K. M. Ryan, R. Luque, M.-M. Titirici, M. N. Collins, *Green Chem.* **2022**, *24*, 8193–8226.
- [263] R. Madhu, A. P. Periasamy, P. Schlee, S. Hérou, M.-M. Titirici, *Carbon* **2023**, *207*, 172–197.
- [264] P. Schlee, O. Hosseinaei, D. Baker, A. Landmér, P. Tomani, M. J. Mostazo-López, D. Cazorla-Amorós, S. Herou, M.-M. Titirici, *Carbon* **2019**, *145*, 470–480.
- [265] P. Schlee, S. Herou, R. Jervis, P. R. Shearing, D. J. L. Brett, D. Baker, O. Hosseinaei, P. Tomani, M. M. Murshed, Y. Li, M. J. Mostazo-López, D. Cazorla-Amorós, A. B. J. Sobrido, M.-M. Titirici, *Chem. Sci.* **2019**, *10*, 2980–2988.
- [266] A. J. Ragauskas, G. T. Beckham, M. J. Biddy, R. Chandra, F. Chen, M. F. Davis, B. H. Davison, R. A. Dixon, P. Gilna, M. Keller, P. Langan, A. K. Naskar, J. N. Saddler, T. J. Tschaplinski, G. A. Tuskan, C. E. Wyman, *Science* **2014**, *344*, 1246843.
- [267] M. H. Sipponen, H. Lange, C. Crestini, A. Henn, M. Österberg, *ChemSusChem* **2019**, *12*, 2039–2054.
- [268] S. Sarkanen, D. C. Teller, E. Abramowski, J. L. McCarthy, *Macromolecules* **1982**, *15*, 1098–1104.
- [269] S. Sarkanen, D. C. Teller, C. R. Stevens, J. L. McCarthy, *Macromolecules* **1984**, *17*, 2588–2597.
- [270] A. Guerra, A. R. Gaspar, S. Contreras, L. A. Lucia, C. Crestini, D. S. Argyropoulos, *Phytochemistry* **2007**, *68*, 2570–2583.
- [271] R. L. Silveira, S. R. Stoyanov, S. Gusarov, M. S. Skaf, A. Kovalenko, *J. Phys. Chem. Lett.* **2015**, *6*, 206–211.
- [272] W. Zhao, L.-P. Xiao, G. Song, R.-C. Sun, L. He, S. Singh, B. A. Simmons, G. Cheng, *Green Chem.* **2017**, *19*, 3272–3281.
- [273] M. Yang, W. Zhao, S. Singh, B. Simmons, G. Cheng, *Nanoscale Adv.* **2019**, *1*, 299–304.
- [274] Q. Tang, Y. Qian, D. Yang, X. Qiu, Y. Qin, M. Zhou, *Polymer* **2020**, *12*, 2471.
- [275] W. Zhao, B. Simmons, S. Singh, A. Ragauskas, G. Cheng, *Green Chem.* **2016**, *18*, 5693–5700.
- [276] S. S. Nair, S. Sharma, Y. Pu, Q. Sun, S. Pan, J. Y. Zhu, Y. Deng, A. J. Ragauskas, *ChemSusChem* **2014**, *7*, 3513–3520.
- [277] W. Zhao, B. Simmons, S. Singh, A. Ragauskas, G. Cheng, *Green Chem.* **2016**, *18*, 5693–5700.
- [278] C. Frangville, M. Rutkevičius, A. P. Richter, O. D. Velev, S. D. Stoyanov, V. N. Paunov, *ChemPhysChem* **2012**, *13*, 4235–4243.
- [279] M. Lievonen, J. J. Valle-Delgado, M.-L. Mattinen, E.-L. Hult, K. Lintinen, M. A. Kostianen, A. Paananen, G. R. Szilvay, H. Setälä, M. Österberg, *Green Chem.* **2016**, *18*, 1416–1422.
- [280] A. P. Richter, B. Bharti, H. B. Armstrong, J. S. Brown, D. Plemmons, V. N. Paunov, S. D. Stoyanov, O. D. Velev, *Langmuir* **2016**, *32*, 6468–6477.
- [281] J. Zhang, Z. Tian, X. Ji, F. Zhang, *Polymer* **2022**, *14*, 4196.
- [282] M. H. Sipponen, H. Lange, M. Ago, C. Crestini, *ACS Sustainable Chem. Eng.* **2018**, *6*, 9342–9351.
- [283] A. Manisekaran, P. Grysan, B. Duez, D. F. Schmidt, D. Lenoble, J.-S. Thomann, *J. Colloid Interface Sci.* **2022**, *626*, 178–192.
- [284] L. Chen, X. Zhou, Y. Shi, B. Gao, J. Wu, T. B. Kirk, J. Xu, W. Xue, *Chem. Eng. J.* **2018**, *346*, 217–225.
- [285] M. B. Agustin, P. A. Penttilä, M. Lahtinen, K. S. Mikkonen, *ACS Sustainable Chem. Eng.* **2019**, *7*, 19925–19934.
- [286] A. P. Richter, J. S. Brown, B. Bharti, A. Wang, S. Gangwal, K. Houck, E. A. Cohen Hubal, V. N. Paunov, S. D. Stoyanov, O. D. Velev, *Nat. Nanotechnol.* **2015**, *10*, 817–823.
- [287] L. Fang, H. Wu, Y. Shi, Y. Tao, Q. Yong, *Front. Bioeng. Biotechnol.* **2021**, *9*.
- [288] C. A. Busatto, M. E. Taverna, M. R. Lescano, C. Zalazar, D. A. Estenoz, *J. Polym. Environ.* **2019**, *27*, 2831–2841.
- [289] M. Morsali, A. Moreno, A. Loukovitou, I. Pylpichuk, M. H. Sipponen, *Biomacromolecules* **2022**, *23*, 4597–4606.
- [290] M. Tortora, F. Cavalieri, P. Mosesso, F. Ciaffardini, F. Melone, C. Crestini, *Biomacromolecules* **2014**, *15*, 1634–1643.
- [291] E. D. Bartzoka, H. Lange, K. Thiel, C. Crestini, *ACS Sustainable Chem. Eng.* **2016**, *4*, 5194–5203.
- [292] L. Zongo, H. Lange, C. Crestini, *ACS Omega* **2019**, *4*, 6979–6993.
- [293] O. Gordobil, R. Herrera, M. Yahyaoui, S. Ilk, M. Kaya, J. Labidi, *RSC Adv.* **2018**, *8*, 24525–24533.
- [294] O. Gordobil, A. Oberemko, G. Saulis, V. Baublys, J. Labidi, *Int. J. Biol. Macromol.* **2019**, *135*, 353–361.
- [295] L. Musilová, A. Mráček, A. Kovalcik, P. Smolka, A. Minařík, P. Humpolíček, R. Vícha, P. Ponížil, *Carbohydr. Polym.* **2018**, *181*, 394–403.
- [296] R. Kumar, A. Butreddy, N. Kommineni, P. G. Reddy, N. Bunekar, C. Sarkar, S. Dutt, V. K. Mishra, K. R. Aadil, Y. K. Mishra, D. Oupicky, A. Kaushik, *Int. J. Nanomed.* **2021**, *16*, 2419–2441.
- [297] D. Schorr, P. N. Diouf, T. Stevanovic, *Ind. Crops Prod.* **2014**, *52*, 65–73.
- [298] D. Yiamsawas, S. J. Beckers, H. Lu, K. Landfester, F. R. Wurm, *ACS Biomater. Sci. Eng.* **2017**, *3*, 2375–2383.
- [299] F. Antunes, I. F. Mota, J. F. Figueiro, G. Lopes, M. Pintado, P. S. Costa, *Int. J. Biol. Macromol.* **2023**, *234*, 123592.
- [300] Z. Yan, G. Liao, X. Zou, M. Zhao, T. Wu, Y. Chen, G. Fang, *J. Agric. Food Chem.* **2020**, *68*, 8341–8349.
- [301] V. Ugartondo, M. Mitjans, M. P. Vinardell, *Bioresour. Technol.* **2008**, *99*, 6683–6687.
- [302] I. Spiridon, C. E. Tanase, *Int. J. Biol. Macromol.* **2018**, *114*, 855–863.
- [303] J. Domínguez-Robles, Á. Cárcamo-Martínez, S. A. Stewart, R. F. Donnelly, E. Larrañeta, M. Borrega, *Sustain. Chem. Pharm.* **2020**, *18*, 100320.
- [304] L. T. Funkenbusch, M. E. Mullins, L. Vamling, T. Belkieri, N. Srethitwat, O. Winjobi, D. R. Shonnard, T. N. Rogers, *WIREs Energy Environ.* **2019**, *8*, e319.
- [305] C. Moretti, B. Corona, R. Hoefnagels, I. Vural-Gürsel, R. Gosselink, M. Junginger, *Sci. Total Environ.* **2021**, *770*, 144656.
- [306] F. Cherubini, A. H. Strømman, S. Ulgiati, *Resour. Conserv. Recycl.* **2011**, *55*, 1070–1077.
- [307] C. Culbertson, T. Treasure, R. Venditti, H. Jameel, R. Gonzalez, *Nord. Pulp Pap. Res. J.* **2016**, *31*, 30–40.
- [308] A. Marson, J. S. M. Samec, A. Manzardo, *Sci. Total Environ.* **2023**, *882*, 163660.

- [309] O. O. Tokede, A. Whittaker, R. Mankaa, M. Traverso, *Structure* **2020**, *25*, 190–199.
- [310] E. Bernier, C. Lavigne, P. Y. Robidoux, *Int. J. Life Cycle Assess.* **2013**, *18*, 520–528.
- [311] F. Hermansson, M. Janssen, M. Svanström, *Int. J. Life Cycle Assess.* **2020**, *25*, 1620–1632.
- [312] M. V. Galkin, D. D. Francesco, U. Edlund, J. S. M. Samec, *Faraday Discuss.* **2017**, *202*, 281–301.
- [313] M. M. Abu-Omar, K. Barta, G. T. Beckham, J. S. Luterbacher, J. Ralph, R. Rinaldi, Y. Román-Leshkov, J. S. M. Samec, B. F. Sels, F. Wang, *Energy Environ. Sci.* **2021**, *14*, 262–292.

Manuscript received: April 6, 2023
Revised manuscript received: July 24, 2023
Accepted manuscript online: July 26, 2023
Version of record online: ■ ■, ■ ■

REVIEW

To be or not to be burnt: that's the question. Read more about kraft lignin: the potential, the chemistry of how it is formed, and state-of-the-art applications in both fuels and materials. A techno-economic discussion discloses two important economic incentives to recover lignin from pulp production.



Prof. Dr. D. D. S. Argyropoulos, Prof. Dr. C. Crestini*, Dr. C. Dahlstrand, Prof. Dr. E. Furusjö, Dr. C. Gioia, Dr. K. Jedvert, Prof. Dr. G. Henriksson, Prof. Dr. C. Hulteberg, Prof. Dr. M. Lawoko, C. Pierrou, Prof. Dr. J. S. M. Samec*, Dr. E. Subbotina, Dr. H. Wallmo, M. Wimby*

1 – 35

Kraft Lignin: A Valuable, Sustainable Resource, Opportunities and Challenges